

Control System Toolbox™

User's Guide

R2012b

MATLAB®

How to Contact MathWorks



www.mathworks.com Web
comp.soft-sys.matlab Newsgroup
www.mathworks.com/contact_TS.html Technical Support



suggest@mathworks.com Product enhancement suggestions
bugs@mathworks.com Bug reports
doc@mathworks.com Documentation error reports
service@mathworks.com Order status, license renewals, passcodes
info@mathworks.com Sales, pricing, and general information



508-647-7000 (Phone)



508-647-7001 (Fax)



The MathWorks, Inc.
3 Apple Hill Drive
Natick, MA 01760-2098

For contact information about worldwide offices, see the MathWorks Web site.

Control System Toolbox™ User's Guide

© COPYRIGHT 2001–2012 by The MathWorks, Inc.

The software described in this document is furnished under a license agreement. The software may be used or copied only under the terms of the license agreement. No part of this manual may be photocopied or reproduced in any form without prior written consent from The MathWorks, Inc.

FEDERAL ACQUISITION: This provision applies to all acquisitions of the Program and Documentation by, for, or through the federal government of the United States. By accepting delivery of the Program or Documentation, the government hereby agrees that this software or documentation qualifies as commercial computer software or commercial computer software documentation as such terms are used or defined in FAR 12.212, DFARS Part 227.72, and DFARS 252.227-7014. Accordingly, the terms and conditions of this Agreement and only those rights specified in this Agreement, shall pertain to and govern the use, modification, reproduction, release, performance, display, and disclosure of the Program and Documentation by the federal government (or other entity acquiring for or through the federal government) and shall supersede any conflicting contractual terms or conditions. If this License fails to meet the government's needs or is inconsistent in any respect with federal procurement law, the government agrees to return the Program and Documentation, unused, to The MathWorks, Inc.

Trademarks

MATLAB and Simulink are registered trademarks of The MathWorks, Inc. See www.mathworks.com/trademarks for a list of additional trademarks. Other product or brand names may be trademarks or registered trademarks of their respective holders.

Patents

MathWorks products are protected by one or more U.S. patents. Please see www.mathworks.com/patents for more information.

Revision History

June 2001	Online only	New for Version 5.1 (Release 12.1)
July 2002	Online only	Revised for Version 5.2 (Release 13)
June 2004	Online only	Revised for Version 6.0 (Release 14)
March 2005	Online only	Revised for Version 6.2 (Release 14SP2)
September 2005	Online only	Revised for Version 6.2.1 (Release 14SP3)
March 2006	Online only	Revised for Version 7.0 (Release 2006a)
September 2006	Online only	Revised for Version 7.1 (Release 2006b)
March 2007	Online only	Revised for Version 8.0 (Release 2007a)
September 2007	Online only	Revised for Version 8.0.1 (Release 2007b)
March 2008	Online only	Revised for Version 8.1 (Release 2008a)
October 2008	Online only	Revised for Version 8.2 (Release 2008b)
March 2009	Online only	Revised for Version 8.3 (Release 2009a)
September 2009	Online only	Revised for Version 8.4 (Release 2009b)
March 2010	Online only	Revised for Version 8.5 (Release 2010a)
September 2010	Online only	Revised for Version 9.0 (Release 2010b)
April 2011	Online only	Revised for Version 9.1 (Release 2011a)
September 2011	Online only	Revised for Version 9.2 (Release 2011b)
March 2012	Online only	Revised for Version 9.3 (Release 2012a)
September 2012	Online only	Revised for Version 9.4 (Release 2012b)

Linear System Modeling

Linear System Model Objects

1

What Are Model Objects?	1-2
Model Objects Represent Linear Systems	1-2
About Model Data	1-2
Control System Modeling with Model Objects	1-4
Types of Model Objects	1-7
Dynamic System Models	1-9
Static Models	1-11
Numeric Models	1-12
Numeric Linear Time Invariant (LTI) Models	1-12
Identified LTI Models	1-12
Identified Nonlinear Models	1-13
Generalized Models	1-14
Generalized and Uncertain LTI Models	1-14
Control Design Blocks	1-14
Generalized Matrices	1-16
Models with Fixed Coefficients	1-18
Numeric LTI Models	1-18
Transfer Functions	1-19
State-Space Models	1-20
Frequency Response Data (FRD) Models	1-22
PID Controllers	1-23

Models with Tunable Coefficients	1-27
Tunable Generalized LTI Models	1-27
Modeling Tunable Components	1-28
Modeling Control Systems with Tunable Components	1-28
Internal Structure of Generalized Models	1-29
Using Model Objects	1-32
Simulink Block for LTI Systems	1-33
References	1-35

Model Creation

2

SISO Model Creation	2-2
Transfer Function Model Using Numerator and Denominator Coefficients	2-2
Transfer Function Model Using Zeros, Poles, and Gain ...	2-3
State-Space Model	2-4
Frequency-Response Model	2-5
Proportional-Integral-Derivative (PID) Controller	2-6
Discrete-Time Model Creation	2-10
Discrete-Time Transfer Function Model	2-10
Discrete-Time Proportional-Integral-Derivative (PID) Controller	2-11
MIMO Model Creation	2-14
MIMO Transfer Function Model	2-14
MIMO State-Space Model	2-15
MIMO Descriptor State-Space Model	2-17
MIMO Frequency Response Data Model	2-18
Select Input/Output Pairs in MIMO Models	2-20
Models with Time Delays	2-21
Modeling Time Delays	2-21
First Order Plus Dead Time Model	2-22

Input and Output Delay in State-Space Model	2-23
Transport Delay in MIMO Transfer Function	2-25
Closing Feedback Loops with Time Delays	2-26
Discrete-Time Transfer Function with Time Delay	2-29
Time-Delay Approximation	2-29
Time-Delay Approximation in Continuous-Time Open-Loop Model	2-30
Time-Delay Approximation in Continuous-Time Closed-Loop Model	2-34
Approximate Different Delays with Different Approximation Orders	2-39
Convert Time Delay to Factors of 1/z in Discrete-Time Model	2-41
Fractional Time-Delay Approximation in Discrete-Time Model	2-43
Frequency Response Data (FRD) Model with Time Delay	2-45
Internal Delays	2-47
Models with Parametric or Tunable Coefficients	2-53
Tunable Low-Pass Filter	2-53
Tunable Second-Order Filter	2-54
State-Space Model with Both Fixed and Tunable Parameters	2-55
Control System with Tunable Components	2-56
Model Arrays	2-59
Model Arrays	2-59
One-Dimensional Model Array with Single Parameter Variation	2-62
Select Models from Array	2-63
Array With Variations in Two Parameters	2-66
Sample a Tunable (Parametric) Model for Parameter Studies	2-68

Working with Linear Models

Data Manipulation

3

Model Properties	3-2
Model Properties	3-2
Specify Model Properties at Model Creation	3-2
Examine and Specify Properties of an Existing Model	3-3
Extract Model Coefficients	3-5
Functions for Extracting Model Coefficients	3-5
Extracting Coefficients of Different Model Type	3-5
Extract Numeric Model Data and Time Delay	3-6
Extract PID Gains from Transfer Function	3-7
Attach Metadata to Models	3-9
Specify Model Time Units	3-9
Interconnect Models with Different Time Units	3-10
Specify Frequency Units of Frequency-Response Data Model	3-10
Extract Subsystems of Multi-Input, Multi-Output (MIMO) Models	3-11
Specify and Select Input and Output Groups	3-12
Query Model Characteristics	3-14
Query Model Dynamics	3-14
Query Array Size	3-15
Customize Model Display	3-17
Configure Transfer Function Display Variable	3-17
Configure Display Format of Transfer Function in Factorized Form	3-18

Model Interconnections

4

Why Interconnect Models?	4-2
Catalog of Model Interconnections	4-3
Arithmetic Operations	4-5
Numeric Model of SISO Feedback Loop	4-6
Tunable Model of SISO Feedback Loop	4-8
Multi-Loop Control System	4-10
MIMO Control System	4-13
MIMO Feedback Loop	4-16
How the Software Determines Properties of Connected Models	4-20
Precedence Rules That Determine Model Type	4-22
Recommended Model Type for Building Block Diagrams	4-23

Model Transformation

5

Conversion Between Model Types	5-2
Explicit Conversion Between Model Types	5-2
Automatic Conversion Between Model Types	5-2
Recommended Working Representation	5-3
Convert PID Controller to Transfer Function	5-4

Get Current Value of Generalized Model by Model Conversion	5-4
Discretize a Compensator	5-6
Improve Accuracy of Discretized System with Time Delay	5-11
Convert Discrete-Time System to Continuous Time ...	5-16
Continuous-Discrete Conversion Methods	5-19
Choosing a Conversion Method	5-19
Zero-Order Hold	5-20
First-Order Hold	5-22
Impulse-Invariant Mapping	5-23
Tustin Approximation	5-24
Zero-Pole Matching Equivalents	5-27
Upsample a Discrete-Time System	5-29
Choosing a Resampling Command	5-33
Why Simplify Models?	5-34
Cancellation Versus Approximation	5-35
Approximate Model with Lower-Order Model	5-37
Choose a Low-Order Approximation Method	5-42
Approximate Model with Unstable or Near-Unstable Pole	5-47
Eliminate States by Pole-Zero Cancellation	5-51

Linear Analysis

Time Domain Analysis

6

Choosing a Time-Domain Analysis Command	6-2
Time-Domain Response Data and Plots	6-3
System Characteristics on Response Plots	6-6
Numeric Values of Time-Domain System Characteristics	6-10
Time-Domain Responses of Discrete-Time Model	6-12
Time-Domain Responses of MIMO Model	6-15
Time-Domain Responses of Multiple Models	6-17
Joint Time- and Frequency-Domain Analysis	6-20
Response from Initial Conditions	6-26
Analysis of Systems with Time Delays	6-29
Considerations to Keep in Mind when Analyzing Systems with Internal Time Delays	6-32

Frequency Domain Analysis

7

Choosing a Frequency-Domain Analysis Command ...	7-2
Frequency Response of a SISO System	7-3

Frequency Response of a MIMO System	7-5
System Characteristics on Response Plots	7-9
Numeric Values of Frequency-Domain Characteristics of SISO Model	7-12
Pole and Zero Locations	7-15
Assessing Gain and Phase Margins	7-18
Analyzing Control Systems with Delays	7-31
Analyzing the Response of an RLC Circuit	7-47

Sensitivity Analysis

8

Plant Model with Single-Parameter Variation	8-2
Plant Model with Multiple-Parameter Variation	8-4
Study Parameter Variation by Sampling Tunable Model	8-6
Sensitivity of Control System to Time Delays	8-8

Control Design

PID Controller Design

9

PID Controller Design at the Command Line	9-2
Designing Cascade Control System with PI Controllers	9-8

Single-Input, Single-Output Control Design

10

Getting Started with the SISO Design Tool	10-2
---	------

Customization

Preliminaries

11

Terminology	11-2
Property and Preferences Hierarchy	11-3
Ways to Customize Plots	11-5

Setting Toolbox Preferences

12

Toolbox Preferences Editor	12-2
----------------------------------	------

Overview of the Toolbox Preferences Editor	12-2
Opening the Toolbox Preferences Editor	12-2
Units Pane	12-4
Style Pane	12-7
Options Pane	12-8
SISO Tool Pane	12-9

Setting Tool Preferences

13

Introduction	13-2
LTI Viewer Preferences Editor	13-3
Opening the LTI Viewer Preference Editor	13-3
Units Pane	13-4
Style Pane	13-6
Options Pane	13-7
Parameters Pane	13-8
Graphical Tuning Window Preferences Editor	13-9
Opening the Graphical Tuning Window Preferences Editor	13-9
Units Pane	13-10
Time Delays Pane	13-11
Style Pane	13-12
Options Pane	13-15
Line Colors Pane	13-16

Introduction	14-2
Customizing Response Plots Using the Response Plots	
Property Editor	14-3
Opening the Property Editor	14-3
Overview of Response Plots Property Editor	14-4
Labels Pane	14-6
Limits Pane	14-6
Units Pane	14-7
Style Pane	14-16
Options Pane	14-17
Editing Subplots Using the Property Editor	14-18
Customizing Response Plots Using Plot Tools	
Properties You Can Customize Using Plot Tools	14-19
Opening and Working with Plot Tools	14-20
Example of Changing Line Color Using Plot Tools	14-20
Customizing Response Plots from the Command	
Line	14-23
Overview of Customizing Plots from the Command Line ..	14-23
Obtaining Plot Handles	14-26
Obtaining Plot Options Handles	14-27
Examples of Customizing Plots from the Command Line ..	14-30
Properties and Values Reference	14-33
Property Organization Reference	14-47
Customizing Plots Inside the SISO Design Tool	
Overview of Customizing SISO Design Tool Plots	14-48
Root Locus Property Editor	14-48
Open-Loop Bode Property Editor	14-52
Open-Loop Nichols Property Editor	14-55
Prefilter Bode Property Editor	14-57

Design Yaw Damper for Jet Transport	15-2
Overview of this Case Study	15-2
Creating the Jet Model	15-2
Computing Open-Loop Eigenvalues	15-4
Open-Loop Analysis	15-5
Root Locus Design	15-8
Washout Filter Design	15-13
Hard-Disk Read/Write Head Controller	15-19
Overview of this Case Study	15-19
Creating the Read/Write Head Model	15-19
Model Discretization	15-20
Adding a Compensator Gain	15-22
Adding a Lead Network	15-23
Design Analysis	15-26
LQG Regulation: Rolling Mill Case Study	15-30
Overview of this Case Study	15-30
Process and Disturbance Models	15-30
LQG Design for the x-Axis	15-33
LQG Design for the y-Axis	15-40
Cross-Coupling Between Axes	15-42
MIMO LQG Design	15-45
Kalman Filtering	15-49
Overview of this Case Study	15-49
Discrete Kalman Filter	15-50
Steady-State Design	15-51
Time-Varying Kalman Filter	15-57
Time-Varying Design	15-58
References	15-62

16

Scaling State-Space Models	16-2
Why Scaling Is Important	16-2
When to Scale Your Model	16-2
Manually Scaling Your Model	16-3

Using the SISO Design Tool and the LTI Viewer

SISO Design Tool

17

SISO Design Tool Overview	17-2
Opening the SISO Design Tool	17-4
Using the SISO Design Task Node	17-5
The SISO Design Task Node	17-5
SISO Design Task Node Menu Bar	17-5
Using the SISO Design Task in the Controls & Estimation Tools Manager	17-12
Architecture	17-12
Compensator Editor	17-19
Graphical Tuning	17-20
Analysis Plots	17-24
Automated Tuning	17-25
SISO Design Task Graphical Tuning Window	17-43
Using the Graphical Tuning Window Menu Bar	17-45
Overview of the Graphical Tuning Window Menu Bar	17-45
File	17-45
Edit	17-48

View	17-49
Analysis	17-50
Tools	17-51
Window	17-55
Help	17-55

Using the Graphical Tuning Window Toolbar	17-57
--	--------------

Using the Right-Click Menus in the Graphical Tuning

Window	17-58
Overview of the Right-Click Menus	17-58
Add Pole/Zero	17-59
Delete Pole/Zero	17-62
Edit Compensator	17-63
Gain Target	17-63
Show	17-63
Multimodel Display	17-64
Design Requirements	17-64
Grid	17-77
Full View	17-77
Properties	17-78
Select Compensator	17-79
Status Pane	17-79

LTI Viewer for SISO Design Task Design

Requirements	17-80
Overview of LTI Viewer Design Requirements	17-80
Available Design Requirements in the LTI Viewer	17-80
Example: Time Domain Requirement	17-81

LTI Viewer

18

LTI Viewer Overview	18-2
Using the Right-Click Menu in the LTI Viewer	18-4
Overview of the Right-Click Menu	18-4
Setting Characteristics of Response Plots	18-4
Adding Design Requirements	18-9

Importing, Exporting, and Deleting Models in the LTI Viewer	18-12
Importing Models	18-12
Exporting Models	18-13
Deleting Models	18-14
Selecting Response Types	18-16
Methods for Selecting Response Types	18-16
Right Click Menu: Plot Type	18-16
Plot Configurations Window	18-16
Line Styles Editor	18-18
Analyzing MIMO Models	18-20
Overview of Analyzing MIMO Models	18-20
Array Selector	18-21
I/O Grouping for MIMO Models	18-23
Selecting I/O Pairs	18-24
Customizing the LTI Viewer	18-25
Overview of Customizing the LTI Viewer	18-25
LTI Viewer Preferences Editor	18-25

Index

Linear System Modeling

- Chapter 1, “Linear System Model Objects”
- Chapter 2, “Model Creation”

Linear System Model Objects

- “What Are Model Objects?” on page 1-2
- “Control System Modeling with Model Objects” on page 1-4
- “Types of Model Objects” on page 1-7
- “Dynamic System Models” on page 1-9
- “Static Models” on page 1-11
- “Numeric Models” on page 1-12
- “Generalized Models” on page 1-14
- “Models with Fixed Coefficients” on page 1-18
- “Models with Tunable Coefficients” on page 1-27
- “Using Model Objects” on page 1-32
- “Simulink Block for LTI Systems” on page 1-33
- “References” on page 1-35

What Are Model Objects?

In this section...
“Model Objects Represent Linear Systems” on page 1-2
“About Model Data” on page 1-2

Model Objects Represent Linear Systems

In Control System Toolbox™, System Identification Toolbox™, and Robust Control Toolbox™ software, you represent linear systems as model objects. *Model objects* are specialized data containers that encapsulate model data and other attributes in a structured way. Model objects allow you to manipulate linear systems as single entities rather than keeping track of multiple data vectors, matrices, or cell arrays.

Model objects can represent single-input, single-output (SISO) systems or multiple-input, multiple-output (MIMO) systems. You can represent both continuous- and discrete-time linear systems.

The main families of model objects are:

- **Numeric Models** — Basic representation of linear systems with fixed numerical coefficients. This family also includes identified models that have coefficients estimated with System Identification Toolbox software.
- **Generalized Models** — Representations that combine numeric coefficients with tunable or uncertain coefficients. Generalized models support tasks such as parameter studies or compensator tuning using Robust Control Toolbox tuning commands.

About Model Data

The data encapsulated in your model object depends on the model type you use. For example:

- Transfer functions store the numerator and denominator coefficients
- State-space models store the A , B , C , and D matrices that describe the dynamics of the system

- PID controller models store the proportional, integral, and derivative gains

Other model attributes stored as model data include time units, names for the model inputs or outputs, and time delays. For more information about setting and retrieving model attributes, see “Model Attributes”.

Note All model objects are MATLAB® objects, but working with them does not require a background in object-oriented programming. To learn more about objects and object syntax, see “Classes in the MATLAB Language” in the MATLAB documentation.

Concepts

- “Control System Modeling with Model Objects” on page 1-4
- “Types of Model Objects” on page 1-7

Control System Modeling with Model Objects

Model objects can represent individual components of a control architecture, such as the plant, actuators, sensors, or controllers. You can connect model objects to build aggregate models of block diagrams that represent the combined response of multiple elements.

For example, the following control system contains a prefilter F , a plant G , and a controller C , arranged in a single-loop configuration. The model also includes a representation of sensor dynamics, S .

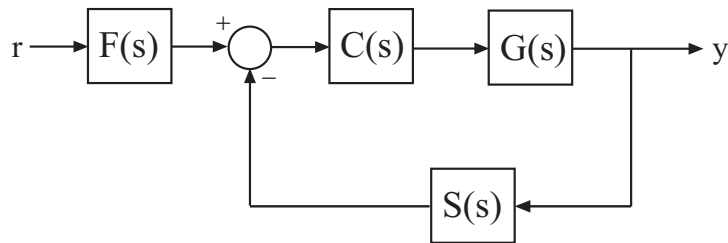

You can represent each of the components as a model object. You do not need to use the same type of model object for each component. For example, represent the plant G as a zero-pole-gain (zpk) model with a double pole at $s = -1$; C as a PID controller, and F and S as transfer functions:

```
G = zpk([], [-1, -1], 1);  
C = pid(2, 1.3, 0.3, 0.5);  
S = tf(5, [1 4]);  
F = tf(1, [1 1]);
```

You can then combine these elements build models that represent your control system or the control system as a whole. For example, create the open-loop response SGC :

```
open_loop = S*G*C;
```

To build a model of the unfiltered closed-loop response, use the `feedback` command:

```
T = feedback(G*C, S);
```

To model the entire closed-loop system response from r to y , combine T with the filter transfer function:

```
Try = T*F;
```

The results `open_loop`, T , and `Try` are also linear model objects. You can operate on them with Control System Toolbox control design and analysis commands. For example, plot the step response of the entire system:

```
step(Try)
```

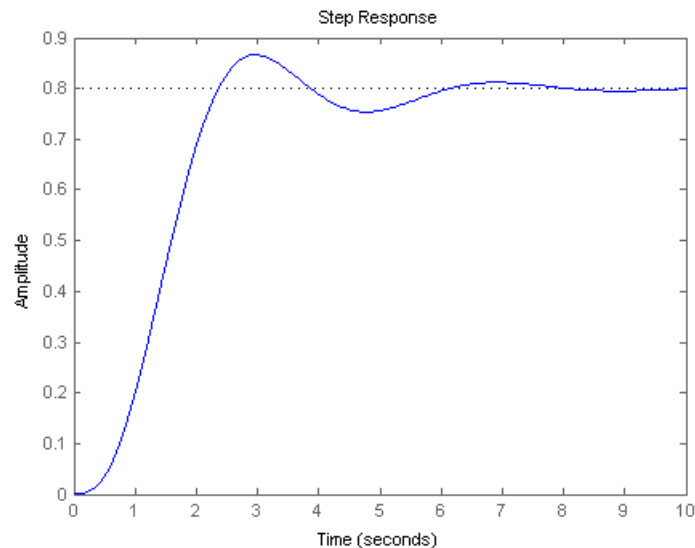

When you combine Numeric LTI models, the resulting Numeric LTI models represent the aggregate model. The resulting models do not retain the original data from the combined components. For example, T does not separately keep track of the dynamics of the components G , C , and S that are combined to create T .

Related Examples

- “Numeric Model of SISO Feedback Loop” on page 4-6
- “Multi-Loop Control System” on page 4-10
- “MIMO Control System” on page 4-13

Concepts

- “Types of Model Objects” on page 1-7

Types of Model Objects

The following diagram illustrates the relationships between the types of model objects in Control System Toolbox, Robust Control Toolbox, and System Identification Toolbox software. Model types that begin with `id` require System Identification Toolbox software. Model types that begin with `u` require Robust Control Toolbox software. All other model types are available with Control System Toolbox software.

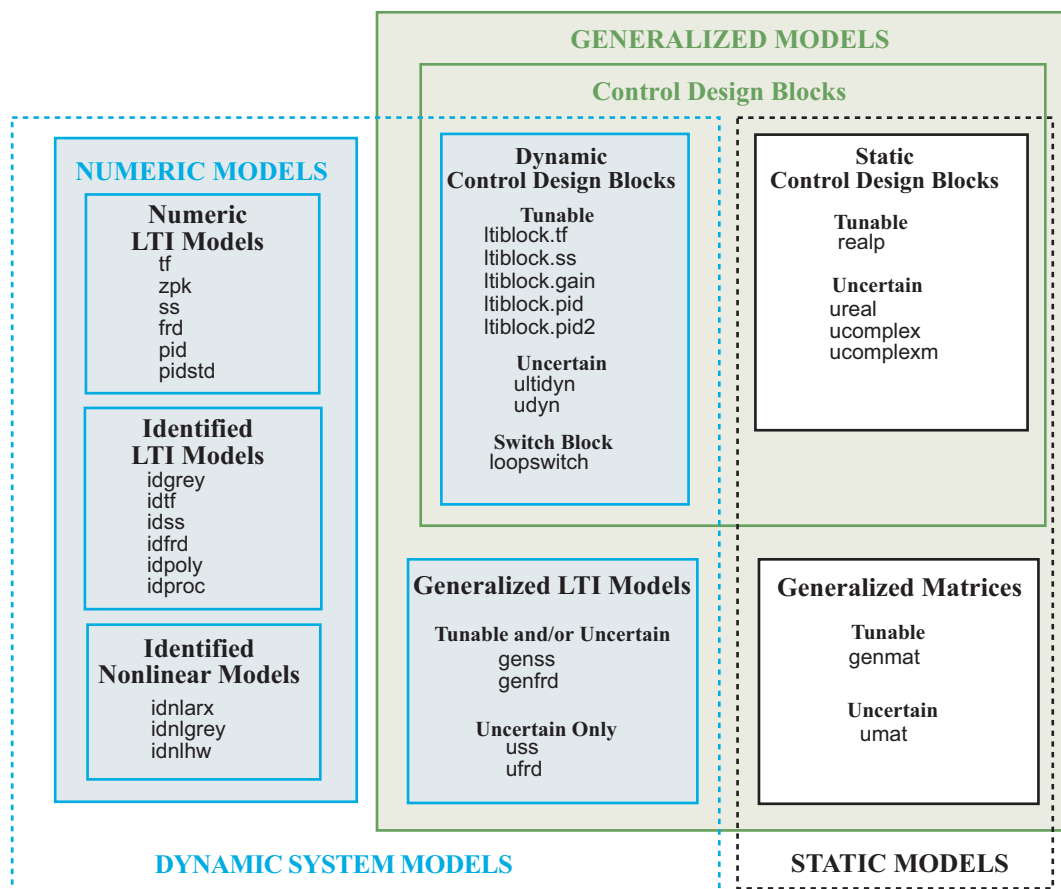

The diagram illustrates the following two overlapping broad classifications of model object types.

- **Dynamic System Models vs. Static Models.** In general, Dynamic System Models represent systems that have internal dynamics, while Static Models represent static input/output relationships.
- **Numeric Models vs. Generalized Models.** Numeric Models are the basic numeric representation of linear systems with fixed coefficients. Generalized Models represent systems with tunable or uncertain components.

Concepts

- “Dynamic System Models” on page 1-9
- “Static Models” on page 1-11
- “Numeric Models” on page 1-12
- “Generalized Models” on page 1-14

Dynamic System Models

Dynamic System Models generally represent systems that have internal dynamics or memory of past states (such as integrators).

Most commands for analyzing linear systems, such as `bode`, `margin`, and `ltiview`, work on most Dynamic System Model objects. For Generalized Models, analysis commands use the current value of tunable parameters and the nominal value of uncertain parameters.

The following table lists the Dynamic System Models.

Model Family	Model Types
Numeric LTI models — Basic numeric representation of linear systems	<code>tf</code>
	<code>zpk</code>
	<code>ss</code>
	<code>frd</code>
	<code>pid</code>
	<code>pidstd</code>
Identified LTI models — Representations of linear systems with tunable coefficients, whose values can be identified using measured input/output data.	<code>idtf</code>
	<code>idss</code>
	<code>idfrd</code>
	<code>idgrey</code>
	<code>idpoly</code>
	<code>idproc</code>
Identified nonlinear models — Representations of nonlinear systems with tunable coefficients, whose values can be identified using input/output data. Limited support for commands that analyze linear systems.	<code>idnlarx</code>
	<code>idnlhw</code>
	<code>idnlgrey</code>

Model Family	Model Types
Generalized LTI models — Representations of systems that include tunable or uncertain coefficients	genss
	genfrd
	uss
	ufrd
Dynamic Control Design Blocks — Tunable, uncertain, or switch components for constructing models of control systems	ltiblock.gain
	ltiblock.tf
	ltiblock.ss
	ltiblock.pid
	ltiblock.pid2
	ultidyn
	udyn
	loopswitch

Concepts

- “Numeric Linear Time Invariant (LTI) Models” on page 1-12
- “Identified LTI Models” on page 1-12
- “Identified Nonlinear Models” on page 1-13
- “Generalized and Uncertain LTI Models” on page 1-14
- “Control Design Blocks” on page 1-14

Static Models

Static Models represent static input/output relationships and generalize the notions of matrix and numeric array to parametric or uncertain arrays. You can use static models to create parametric or uncertain expressions, and to construct Generalized LTI models whose coefficients are parametric or uncertain expressions. The Static Models family includes:

- Tunable parameters (`realp` objects)
- Generalized matrices (`genmat` objects)
- Uncertain parameters and matrices (`ureal`, `ucomplex`, `ucomplexm`) (requires Robust Control Toolbox software)
- Uncertain matrices (`umat`) objects (requires Robust Control Toolbox software)

For more information about using these objects to create parametric models, see “Models with Tunable Coefficients” on page 1-27. For information about creating uncertain static models, see “Uncertain Real Parameters” and “Uncertain Matrices” in the Robust Control Toolbox documentation.

Numeric Models

Numeric Linear Time Invariant (LTI) Models

Numeric LTI models are the basic numeric representation of linear systems or components of linear systems. Use numeric LTI models for modeling dynamic components, such as transfer functions or state-space models, whose coefficients are fixed, numeric values. You can use numeric LTI models for linear analysis or control design tasks.

The following table summarizes the available types of numeric LTI models.

Model Type	Description
tf	Transfer function model in polynomial form
zpk	Transfer function model in zero-pole-gain (factorized) form
ss	State-space model
frd	Frequency response data model
pid	Parallel-form PID controller
pidstd	Standard-form PID controller

Identified LTI Models

Identified LTI Models represent linear systems with coefficients that are identified using measured input/output data (requires System Identification Toolbox software). You can specify initial values and constraints for the estimation of the coefficients.

The following table summarizes the available types of identified LTI models.

Model Type	Description
idtf	Transfer function model in polynomial form, with identifiable parameters
idss	State-space model, with identifiable parameters

Model Type	Description
idpoly	Polynomial input-output model, with identifiable parameters
idproc	Continuous-time process model, with identifiable parameters
idfrd	Frequency-response model, with identifiable parameters
idgrey	Linear ODE (grey-box) model, with identifiable parameters

Identified Nonlinear Models

Identified Nonlinear Models represent nonlinear systems with coefficients that are identified using measured input/output data (requires System Identification Toolbox software). You can specify initial values and constraints for the estimation of the coefficients.

The following table summarizes the available types of identified nonlinear models.

Model Type	Description
idnlarx	Nonlinear ARX model, with identifiable parameters
idnlgrey	Nonlinear ODE (grey-box) model, with identifiable parameters
idnlhw	Hammerstein-Wiener model, with identifiable parameters

Concepts

- “Models with Fixed Coefficients” on page 1-18

Generalized Models

Generalized and Uncertain LTI Models

Generalized LTI Models represent systems having a mixture of fixed coefficients and tunable or uncertain coefficients. Generalized LTI models arise from combining numeric LTI models with Control Design Blocks. For more information about tunable Generalized LTI models and their applications, see “Models with Tunable Coefficients” on page 1-27.

Uncertain LTI Models are a special type of Generalized LTI model that include uncertain coefficients but not tunable coefficients. For more information about using uncertain models, see “Uncertain State-Space Models (uss)” and “Create Uncertain Frequency Response Data Models” in the Robust Control Toolbox documentation.

Family	Model Type	Description
Generalized LTI Models	genss	Generalized LTI model arising from combination of Numeric LTI models (except frd models) with Control Design Blocks
	genfrd	Generalized LTI model arising from combination frd models with Control Design Blocks
Uncertain LTI Models (requires Robust Control Toolbox software)	uss	Generalized LTI model arising from combination of Numeric LTI models (except frd models) with uncertain Control Design Blocks
	ufrd	Generalized LTI model arising from combination frd models with uncertain Control Design Blocks

Control Design Blocks

Control Design Blocks are building blocks for constructing tunable or uncertain models of control systems. Combine tunable Control Design Blocks

with numeric arrays or Numeric LTI models to create Generalized Matrices or Generalized LTI models that include both fixed and tunable components.

Tunable Control Design Blocks include tunable parameter objects as well as tunable linear models with predefined structure. For more information about using tunable Control Design Blocks, see “Models with Tunable Coefficients” on page 1-27.

If you have Robust Control Toolbox software, you can use uncertain Control Design Blocks to model uncertain parameters or uncertain system dynamics. For more information about using uncertain blocks, see “Uncertain LTI Dynamics Elements”, “Uncertain Real Parameters”, and “Uncertain Complex Parameters and Matrices” in the Robust Control Toolbox documentation.

The following tables summarize the available types of Control Design Blocks.

Dynamic System Model Control Design Blocks

Family	Model Type	Description
Tunable Linear Components	<code>ltiblock.gain</code>	Tunable gain block
	<code>ltiblock.tf</code>	SISO fixed-order transfer function with tunable coefficients
	<code>ltiblock.ss</code>	Fixed-order state-space model with tunable coefficients
	<code>ltiblock.pid</code>	One-degree-of-freedom PID controller with tunable coefficients
	<code>ltiblock.pid2</code>	Two-degree-of-freedom PID controller with tunable coefficients

Dynamic System Model Control Design Blocks (Continued)

Family	Model Type	Description
Uncertain Dynamics (requires Robust Control Toolbox software)	ultidyn	Uncertain linear time-invariant dynamics
	udyn	Unstructured uncertain dynamics
Switch Block	loopswitch	Switch for marking potential loop-opening location in model

Static Model Control Design Blocks

Family	Model Type	Description
Tunable Parameter	realp	Tunable scalar parameter or matrix
Uncertain Parameters (requires Robust Control Toolbox software)	ureal	Uncertain real scalar
	ucomplex	Uncertain complex scalar
	ucomplexm	Uncertain complex matrix

Generalized Matrices

Generalized Matrices extend the notion of numeric matrices to matrices that include tunable or uncertain values.

Create tunable generalized matrices by building rational expressions involving `realp` parameters. You can use generalized matrices as inputs to `tf` or `ss` to create tunable linear models with structures other than the predefined structures of the Control Design Blocks. Use such models for parameter studies or some compensator tuning tasks.

If you have Robust Control Toolbox software, you can create uncertain matrices by building rational expressions involving uncertain parameters such as `ureal` or `ucomplex`.

Model Type	Description
<code>genmat</code>	Generalized matrix that includes parametric or tunable entries
<code>umat</code> (requires Robust Control Toolbox software)	Generalized matrix that includes uncertain entries

For more information about generalized matrices and their applications, see “Models with Tunable Coefficients” on page 1-27.

Models with Fixed Coefficients

In this section...
“Numeric LTI Models” on page 1-18
“Transfer Functions” on page 1-19
“State-Space Models” on page 1-20
“Frequency Response Data (FRD) Models” on page 1-22
“PID Controllers” on page 1-23

Numeric LTI Models

Numeric LTI models are the basic representation of linear systems or components of linear systems whose coefficients are fixed numeric values.

Applications of Numeric LTI Models

You can use Numeric LTI models to represent block diagram components such as plant or sensor dynamics. By connecting Numeric LTI models together, you can derive Numeric LTI models of block diagrams. Use Numeric LTI models for most modeling, analysis, and control design tasks, including:

- Analyzing linear system dynamics using analysis commands such as `bode`, `step`, or `impz`.
- Designing controllers for linear systems using “SISO Design Tool” or the PID Tuner GUI.
- Designing controllers using control design commands such as `pidtune`, `rlocus`, or `lqr/lqg`.

Types of Numeric LTI Models

Control System Toolbox includes the following types of numeric LTI models:

- “Transfer Functions” on page 1-19
- “State-Space Models” on page 1-20
- “Frequency Response Data (FRD) Models” on page 1-22

- “PID Controllers” on page 1-23

Transfer Functions

- “Transfer Function Representations” on page 1-19
- “Commands for Creating Transfer Functions” on page 1-20

Transfer Function Representations

Control System Toolbox software supports transfer functions that are continuous-time or discrete-time, and SISO or MIMO. You can also have time delays in your transfer function representation.

A SISO transfer function is expressed as the ratio:

$$G(s) = \frac{N(s)}{D(s)},$$

of polynomials $N(s)$ and $D(s)$, called the numerator and denominator polynomials, respectively.

You can represent linear systems as transfer functions in polynomial or factorized (zero-pole-gain) form. For example, the polynomial-form transfer function:

$$G(s) = \frac{s^2 - 3s - 4}{s^2 + 5s + 6}$$

can be rewritten in factorized form as:

$$G(s) = \frac{(s+1)(s-4)}{(s+2)(s+3)}.$$

The `tf` model object represents transfer functions in polynomial form. The `zpk` model object represents transfer functions in factorized form.

MIMO transfer functions are arrays of SISO transfer functions. For example:

$$G(s) = \begin{bmatrix} \frac{s-3}{s+4} \\ \frac{s+1}{s+2} \end{bmatrix}$$

is a one-input, two output transfer function.

Commands for Creating Transfer Functions

Use the commands described in the following table to create transfer functions.

Command	Description
<code>tf</code>	Create <code>tf</code> objects representing continuous-time or discrete-time transfer functions in polynomial form.
<code>zpk</code>	Create <code>zpk</code> objects representing continuous-time or discrete-time transfer functions in zero-pole-gain (factorized) form.
<code>filt</code>	Create <code>tf</code> objects representing discrete-time transfer functions using digital signal processing (DSP) convention.

State-Space Models

- “State-Space Model Representations” on page 1-20
- “Explicit State-Space Models” on page 1-21
- “Descriptor (Implicit) State-Space Models” on page 1-21
- “Commands for Creating State-Space Models” on page 1-22

State-Space Model Representations

State-space models rely on linear differential equations or difference equations to describe system dynamics. Control System Toolbox software supports SISO or MIMO state-space models in continuous or discrete time.

State-space models can include time delays. You can represent state-space models in either explicit or descriptor (implicit) form.

State-space models can result from:

- Linearizing a set of ordinary differential equations that represent a physical model of the system.
- State-space model identification using System Identification Toolbox software.
- State-space realization of transfer functions. (See “Conversion Between Model Types” on page 5-2 for more information.)

Use `ss` model objects to represent state-space models.

Explicit State-Space Models

Explicit continuous-time state-space models have the following form:

$$\begin{aligned}\frac{dx}{dt} &= Ax + Bu \\ y &= Cx + Du\end{aligned}$$

where x is the state vector, u is the input vector, and y is the output vector. A , B , C , and D are the state-space matrices that express the system dynamics.

A discrete-time explicit state-space model takes the following form:

$$\begin{aligned}x[n+1] &= Ax[n] + Bu[n] \\ y[n] &= Cx[n] + Du[n]\end{aligned}$$

where the vectors $x[n]$, $u[n]$, and $y[n]$ are the state, input, and output vectors for the n th sample.

Descriptor (Implicit) State-Space Models

A *descriptor state-space model* is a generalized form of state-space model. In continuous time, a descriptor state-space model takes the following form:

$$E \frac{dx}{dt} = Ax + Bu$$

$$y = Cx + Du$$

where x is the state vector. u is the input vector, and y is the output vector. A , B , C , D , and E are the state-space matrices.

Commands for Creating State-Space Models

Use the commands described in the following table to create state-space models.

Command	Description
ss	Create explicit state-space model.
dss	Create descriptor (implicit) state-space model.
delayss	Create state-space models with specified time delays.

Frequency Response Data (FRD) Models

- “Frequency Response Data” on page 1-22
- “Commands for Creating FRD Models” on page 1-23

Frequency Response Data

In the Control System Toolbox software, you can use `frd` models to store, manipulate, and analyze frequency response data. An `frd` model stores a vector of frequency points with the corresponding complex frequency response data you obtain either through simulations or experimentally.

For example, suppose you measure frequency response data for the SISO system you want to model. You can measure such data by driving the system with a sine wave at a set of frequencies $\omega_1, \omega_2, \dots, \omega_n$, as shown:

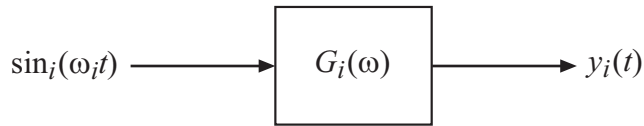

At steady state, the measured response $y_i(t)$ to the driving signal at each frequency ω_i takes the following form:

$$y_i(t) = a \sin(\omega_i t + b), \quad i = 1, \dots, n.$$

The measurement yields the complex frequency response G at each input frequency:

$$G(j\omega_i) = ae^{jb}, \quad i = 1, \dots, n.$$

You can do most frequency-domain analysis tasks on `frd` models, but you cannot perform time-domain simulations with them. For information on frequency response analysis of linear systems, see Chapter 8 of [1].

Commands for Creating FRD Models

Use the following commands to create FRD models.

Command	Description
<code>frd</code>	Create <code>frd</code> objects from frequency response data.
<code>frestimate</code>	Create <code>frd</code> objects by estimating the frequency response of a Simulink® model. This approach requires Simulink Control Design™ software. See “Frequency Response Estimation” in the Simulink Control Design documentation for more information.

PID Controllers

- “Continuous-Time PID Controller Representations” on page 1-24
- “Discrete-Time PID Controllers” on page 1-25

Continuous-Time PID Controller Representations

You can represent continuous-time Proportional-Integral-Derivative (PID) controllers in either parallel or standard form. The two forms differ in the parameters used to express the proportional, integral, and derivative actions and the filter on the derivative term, as shown in the following table.

Form	Formula
Parallel	$C = K_p + \frac{K_i}{s} + \frac{K_d s}{T_f s + 1},$ <p>where:</p> <ul style="list-style-type: none"> • K_p = proportional gain • K_i = integrator gain • K_d = derivative gain • T_f = derivative filter time
Standard	$C = K_p \left(1 + \frac{1}{T_i s} + \frac{T_d s}{\frac{T_d}{N} s + 1} \right),$ <p>where:</p> <ul style="list-style-type: none"> • K_p = proportional gain • T_i = integrator time • T_d = derivative time • N = derivative filter constant

Use a controller form that is convenient for your application. For example, if you want to express the integrator and derivative actions in terms of time constants, use Standard form.

Discrete-Time PID Controllers

Discrete-time PID controllers are expressed by the following formulas.

Form	Formula
Parallel	$C = K_p + K_i IF(z) + \frac{K_d}{T_f + DF(z)},$ <p>where:</p> <ul style="list-style-type: none"> • K_p = proportional gain • K_i = integrator gain • K_d = derivative gain • T_f = derivative filter time
Standard	$C = K_p \left(1 + \frac{1}{T_i} IF(z) + \frac{T_d}{\frac{T_d}{N} + DF(z)} \right),$ <p>where:</p> <ul style="list-style-type: none"> • K_p = proportional gain • T_i = integrator time • T_d = derivative time • N = derivative filter constant

$IF(z)$ and $DF(z)$ are the discrete integrator formulas for the integrator and derivative filter, respectively. Use the `IFormula` and `DFormula` properties of the `pid` or `pidstd` model objects to set the $IF(z)$ and $DF(z)$ formulas. The next table shows available formulas for $IF(z)$ and $DF(z)$. T_s is the sample time.

IFormula or DFormula	IF(z) or DF(z)
ForwardEuler (default)	$\frac{T_s}{z-1}$
BackwardEuler	$\frac{T_s z}{z-1}$
Trapezoidal	$\frac{T_s}{2} \frac{z+1}{z-1}$

If you do not specify a value for IFormula, DFormula, or both, ForwardEuler is used by default.

Models with Tunable Coefficients

In this section...

“Tunable Generalized LTI Models” on page 1-27

“Modeling Tunable Components” on page 1-28

“Modeling Control Systems with Tunable Components” on page 1-28

“Internal Structure of Generalized Models” on page 1-29

Tunable Generalized LTI Models

Tunable Generalized LTI models represent systems having both fixed and tunable (or parametric) coefficients.

You can use tunable Generalized LTI models to:

- Model a tunable (or parametric) component of a control system, such as a tunable low-pass filter.
- Model a control system that contains both:
 - Fixed components, such as plant dynamics and sensor dynamics
 - Tunable components, such as filters and compensators

You can use tunable Generalized LTI models for parameter studies. For an example, see “Sample a Tunable (Parametric) Model for Parameter Studies” on page 2-68.

If you have Robust Control Toolbox software, you can use tunable Generalized LTI models for tuning fixed control structures using tuning commands such as `systune` and `looptune`. See Robust Control Toolbox documentation:

- “Automated Tuning”
- “Automated Loop-Shaping Design”
- “H-Infinity Synthesis”

Modeling Tunable Components

Control System Toolbox includes tunable components with predefined structure called “Control Design Blocks” on page 1-14. You can use tunable Control Design Blocks to model any tunable component that fits one of the predefined structures.

To create tunable components with a specific custom structure that is not covered by the Control Design Blocks:

- 1 Use the tunable real parameter `realp` or the generalized matrix `genmat` to represent the tunable coefficients of your component.
- 2 Use the resulting `realp` or `genmat` objects as inputs to `tf` or `ss` to model the component. The result is a generalized state-space (`genss`) model of the component.

For examples of creating such custom tunable components, see:

- “Tunable Low-Pass Filter” on page 2-53
- “Tunable Second-Order Filter” on page 2-54
- “State-Space Model with Both Fixed and Tunable Parameters” on page 2-55

Modeling Control Systems with Tunable Components

To construct a tunable Generalized LTI model representing a control system with both fixed and tunable components:

- 1 Model the nontunable components of your system using Numeric LTI models.
- 2 Model each tunable component using Control Design Blocks or expressions involving such blocks. See “Modeling Tunable Components” on page 1-28.
- 3 Use model interconnection commands such as `series`, `parallel` or `connect`, or the arithmetic operators `+`, `-`, `*`, `/`, `\`, and `^`, to combine all the components of your system.

The resulting model is:

- A `genss` model, if none of the nontunable components is a frequency response data model (for example, `frd`)
- A `genfrd` model, if the nontunable component is a `frd` model

For an example of constructing a `genss` model of a control system with both fixed and tunable components, see “Control System with Tunable Components” on page 2-56.

Internal Structure of Generalized Models

A Generalized model separately stores the numeric and parametric portions of the model by structuring the model in *Standard Form*, as shown in the following illustration.

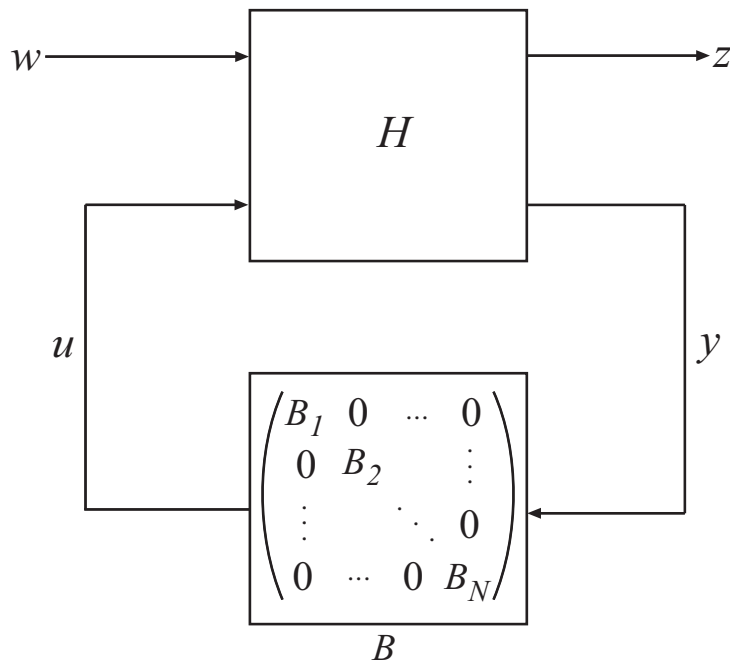

w and z represent the inputs and outputs of the Generalized model.

H represents all portions of the Generalized model that have fixed (non-parametric) coefficients. H is:

- A state-space (ss) model, for `genss` models
- A frequency response data (frd) model, for `genfrd` models
- A matrix, for `genmat` models

B represents the parametric components of the Generalized model, which are the Control Design Blocks B_1, \dots, B_N . The `Blocks` property of the Generalized model stores a list of the names of these blocks. If the Generalized model has blocks that occur multiple times in B_1, \dots, B_N , these are only listed once in the `Blocks` property.

To access the internal representation of a Generalized model, including H and B , use the `getLFTModel` command.

This Standard Form can represent any control structure. To understand why, consider the control structure as an aggregation of fixed-coefficient elements interacting with the parametric elements:

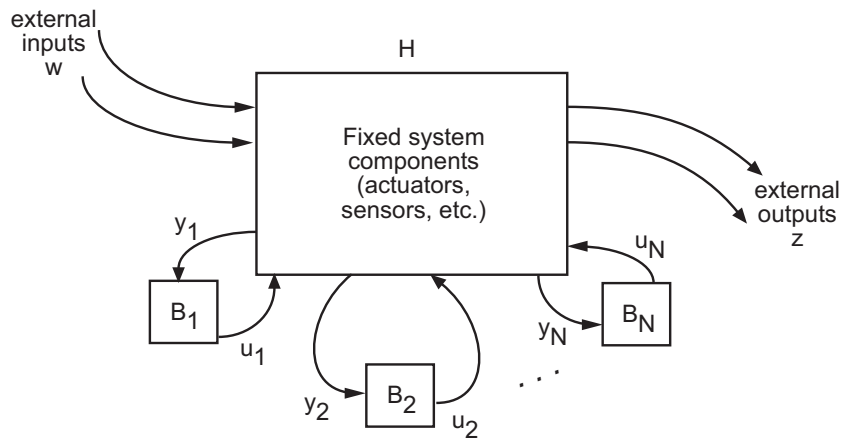

To rewrite this in Standard Form, define

$$u := [u_1, \dots, u_N]$$
$$y := [y_1, \dots, y_N],$$

and group the tunable control elements B_1, \dots, B_N into the block-diagonal configuration C . P includes all the fixed components of the control architecture—actuators, sensors, and other nontunable elements—and their interconnections.

Using Model Objects

After you represent your dynamic system as a model object, you can:

- Attach additional information to the model using model attributes (properties). See “Model Attributes”.
- Manipulate the model using arithmetic and model interconnection operations. See “Model Interconnection”.
- Analyze the model response using commands such as `bode` and `step`. See “Linear Analysis”.
- Perform parameter studies using model arrays. See “Model Arrays”.
- Design compensators. You can:
 - Design compensators for systems specified as numeric LTI models. Available compensator design techniques include PID tuning, root locus analysis, pole placement, LQG optimal control, and frequency domain loop-shaping. See “PID Controller Tuning”, “SISO Feedback Loops”, or “Linear-Quadratic-Gaussian Control”.
 - Manually tune many control architectures using the SISO Design Tool. See “SISO Feedback Loops”.
 - Use tuning commands such as `systemtune`, `looptune`, or `hinfstruct` to automatically tune a control system that you represent as a `genss` model with tunable blocks (requires Robust Control Toolbox software). See Robust Control Toolbox documentation:
 - “Automated Tuning”
 - “Automated Loop-Shaping Design”
 - “H-Infinity Synthesis”

Simulink Block for LTI Systems

You can incorporate model objects into Simulink diagrams using the LTI System block shown below.

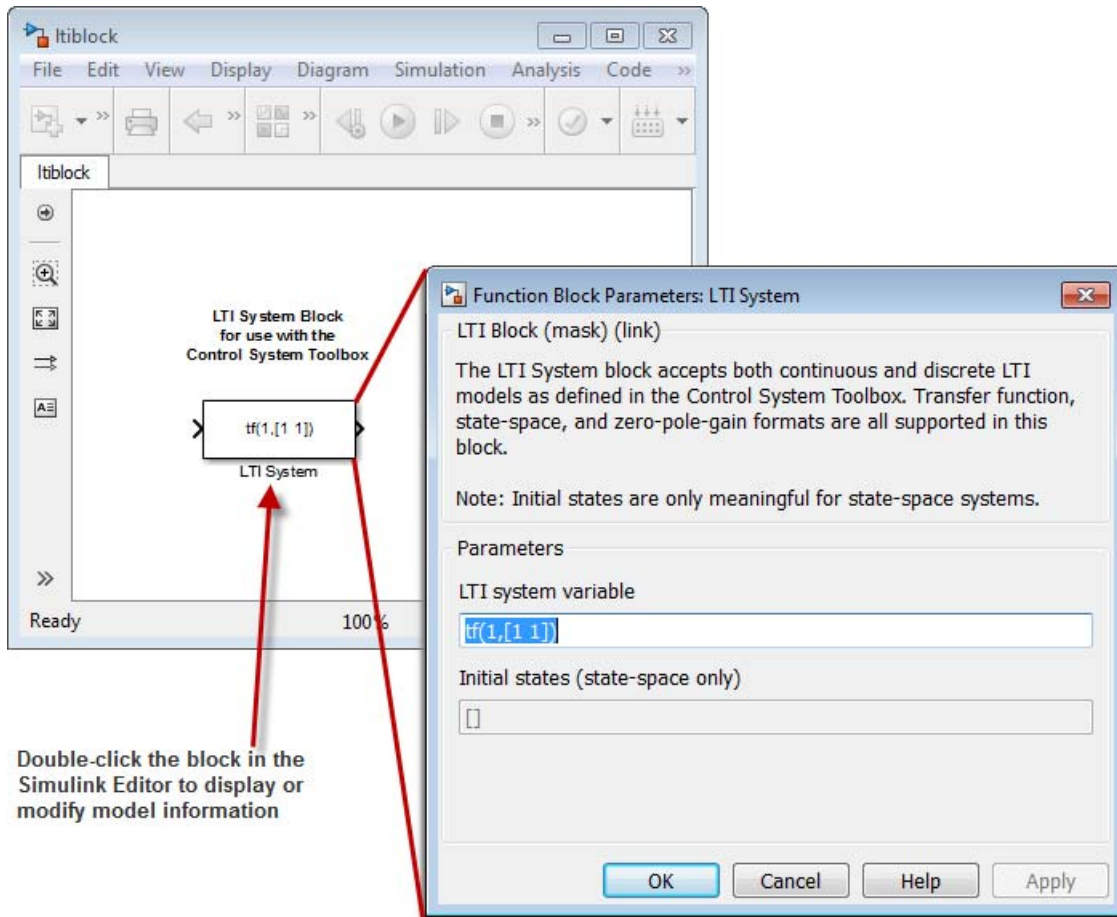

Double-click the block in the Simulink Editor to display or modify model information

The LTI System block can be accessed either by typing
`ltiblock`

at the MATLAB prompt or from the **Control System Toolbox** section of the main Simulink library.

The LTI System block consists of the dialog box shown on the right in the figure above. In the editable text box labeled **LTI system variable**, enter either the variable name of an LTI object located in the MATLAB workspace (for example, `sys`) or a MATLAB expression that evaluates to an LTI object (for example, `tf(1,[1 1])`). The LTI System block accepts both continuous and discrete LTI objects in either transfer function, zero-pole-gain, or state-space form. All types of delays are supported in the LTI block. Simulink converts the model to its state-space equivalent prior to initializing the simulation.

Use the editable text box labeled **Initial states** to enter an initial state vector for state-space models. The concept of "initial state" is not well-defined for transfer functions or zero-pole-gain models, as it depends on the choice of state coordinates used by the realization algorithm. As a result, you cannot enter nonzero initial states when you supply TF or ZPK models to LTI blocks in a Simulink diagram.

References

- [1] Dorf, R.C. and R.H. Bishop, *Modern Control Systems*, Addison-Wesley, Menlo Park, CA, 1998.

Model Creation

- “SISO Model Creation” on page 2-2
- “Discrete-Time Model Creation” on page 2-10
- “MIMO Model Creation” on page 2-14
- “Models with Time Delays” on page 2-21
- “Models with Parametric or Tunable Coefficients” on page 2-53
- “Model Arrays” on page 2-59

SISO Model Creation

How to create continuous-time single-input, single-output (SISO) models.

In this section...

“Transfer Function Model Using Numerator and Denominator Coefficients” on page 2-2

“Transfer Function Model Using Zeros, Poles, and Gain” on page 2-3

“State-Space Model” on page 2-4

“Frequency-Response Model” on page 2-5

“Proportional-Integral-Derivative (PID) Controller” on page 2-6

Transfer Function Model Using Numerator and Denominator Coefficients

This example shows how to create continuous-time single-input, single-output (SISO) transfer functions from their numerator and denominator coefficients using `tf`.

Create the transfer function $G(s) = \frac{s}{s^2 + 3s + 2}$:

```
num = [1 0];  
den = [1 3 2];  
G = tf(num,den);
```

`num` and `den` are the numerator and denominator polynomial coefficients in descending powers of s . For example, `den = [1 3 2]` represents the denominator polynomial $s^2 + 3s + 2$.

`G` is a `tf` model object, which is a data container for representing transfer functions in polynomial form.

Tip Alternatively, you can specify the transfer function $G(s)$ as an expression in s :

1 Create a transfer function model for the variable s .

```
s = tf('s');
```

2 Specify $G(s)$ as a ratio of polynomials in s .

```
G = s/(s^2 + 3*s + 2);
```

More About

- “What Are Model Objects?” on page 1-2
- “Transfer Functions” on page 1-19

Transfer Function Model Using Zeros, Poles, and Gain

This example shows how to create single-input, single-output (SISO) transfer functions in factored form using `zpk`.

Create the factored transfer function $G(s) = 5 \frac{s}{(s+1+i)(s+1-i)(s+2)}$:

```
Z = [0];
P = [-1-1i -1+1i -2];
K = 5;
G = zpk(Z,P,K);
```

Z and P are the zeros and poles (the roots of the numerator and denominator, respectively). K is the gain of the factored form. For example, $G(s)$ has a real pole at $s = -2$ and a pair of complex poles at $s = -1 \pm i$. The vector $P = [-1-1i -1+1i -2]$ specifies these pole locations.

G is a `zpk` model object, which is a data container for representing transfer functions in zero-pole-gain (factorized) form.

More About

- “What Are Model Objects?” on page 1-2
- “Transfer Functions” on page 1-19

State-Space Model

This example shows how to create a continuous-time single-input, single-output (SISO) state-space model from state-space matrices using `ss`.

Create a model of an electric motor where the state-space equations are:

$$\begin{aligned}\frac{dx}{dt} &= Ax + Bu \\ y &= Cx + Du\end{aligned}$$

where the state variables are the angular position θ and angular velocity $d\theta/dt$:

$$x = \begin{bmatrix} \theta \\ \frac{d\theta}{dt} \end{bmatrix},$$

u is the electric current, the output y is the angular velocity, and the state-space matrices are:

$$A = \begin{bmatrix} 0 & 1 \\ -5 & -2 \end{bmatrix}, \quad B = \begin{bmatrix} 0 \\ 3 \end{bmatrix}, \quad C = [0 \ 1], \quad D = [0].$$

To create this model, enter:

```
A = [0 1; -5 -2];  
B = [0; 3];  
C = [0 1];  
D = 0;  
sys = ss(A,B,C,D);
```

`sys` is an `ss` model object, which is a data container for representing state-space models.

Tip To represent a system of the form:

$$E \frac{dx}{dt} = Ax + Bu$$
$$y = Cx + Du$$

use `dss`. This command creates a `ss` model with a nonempty `E` matrix, also called a descriptor state-space model. See “MIMO Descriptor State-Space Model” on page 2-17 for an example.

More About

- “What Are Model Objects?” on page 1-2
- “State-Space Models” on page 1-20

Frequency-Response Model

This example shows how to create a single-input, single-output (SISO) frequency-response model using `frd`.

A frequency-response model stores a vector of frequency points with corresponding complex frequency response data you obtain either through simulations or experimentally. Thus, if you measure the frequency response of your system at a set of test frequencies, you can use the data to create a frequency response model:

- 1 Load the frequency response data in `AnalyzerData.mat`.

```
load AnalyzerData
```

This command loads the data into the MATLAB workspace as the column vectors `freq` and `resp`. The variables `freq` and `resp` contain 256 test frequencies and the corresponding complex-valued frequency response points, respectively.

Tip To inspect these variables, enter:

```
whos freq resp
```

2 Create a frequency response model.

```
sys = frd(resp, freq);
```

`sys` is an `frd` model object, which is a data container for representing frequency response data.

You can use `frd` models with many frequency-domain analysis commands. For example, visualize the frequency response data using `bode`.

Tip By default, the `frd` command assumes that the frequencies are in radians/second. To specify different frequency units, use the `TimeUnit` and `FrequencyUnit` properties of the `frd` model object. For example:

```
sys = frd(resp, freq, 'TimeUnit', 'min', 'FrequencyUnit', 'rad/TimeUnit')
```

sets the frequency units to radians/minute.

More About

- “What Are Model Objects?” on page 1-2
- “Frequency Response Data (FRD) Models” on page 1-22

Proportional-Integral-Derivative (PID) Controller

How to create models representing PID controllers.

- “Continuous-Time PID Controller Representations” on page 2-7
- “Create Continuous-Time Parallel-Form PID Controller” on page 2-8
- “Create Continuous-Time Standard-Form PID Controller” on page 2-8

Continuous-Time PID Controller Representations

You can represent continuous-time Proportional-Integral-Derivative (PID) controllers in either parallel or standard form. The two forms differ in the parameters used to express the proportional, integral, and derivative actions and the filter on the derivative term, as shown in the following table.

Form	Formula
Parallel	$C = K_p + \frac{K_i}{s} + \frac{K_d s}{T_f s + 1},$ <p>where:</p> <ul style="list-style-type: none"> • K_p = proportional gain • K_i = integrator gain • K_d = derivative gain • T_f = derivative filter time
Standard	$C = K_p \left(1 + \frac{1}{T_i s} + \frac{T_d s}{N s + 1} \right),$ <p>where:</p> <ul style="list-style-type: none"> • K_p = proportional gain • T_i = integrator time • T_d = derivative time • N = derivative filter constant

Use a controller form that is convenient for your application. For example, if you want to express the integrator and derivative actions in terms of time constants, use Standard form.

See “Discrete-Time Proportional-Integral-Derivative (PID) Controller” on page 2-11 for information on creating PID Controllers in discrete time.

Create Continuous-Time Parallel-Form PID Controller

This example shows how to create a continuous-time Proportional-Integral-Derivative (PID) controller in parallel form using `pid`.

Create the following parallel-form PID controller: $C = 29.5 + \frac{26.2}{s} - \frac{4.3s}{0.06s + 1}$.

```
Kp = 29.5;  
Ki = 26.2;  
Kd = 4.3;  
Tf = 0.06;  
C = pid(Kp,Ki,Kd,Tf)
```

C is a `pid` model object, which is a data container for representing parallel-form PID controllers.

Create Continuous-Time Standard-Form PID Controller

This example shows how to create a continuous-time Proportional-Integral-Derivative (PID) controller in standard form using `pidstd`.

Create the following standard-form PID controller:

$$C = 29.5 \left(1 + \frac{1}{1.13s} + \frac{0.15s}{2.3s + 1} \right)$$

```
Kp = 29.5;  
Ti = 1.13;  
Td = 0.15;  
N = 2.3;  
C = pid(Kp,Ki,Kd,Tf)
```

C is a `pidstd` model object, which is a data container for representing standard-form PID controllers.

More About

- “What Are Model Objects?” on page 1-2
- “PID Controllers” on page 1-23

Discrete-Time Model Creation

How to create discrete-time models.

- “Discrete-Time Transfer Function Model” on page 2-10
- “Discrete-Time Proportional-Integral-Derivative (PID) Controller” on page 2-11

Discrete-Time Transfer Function Model

This example shows how to create a discrete-time transfer function model using `tf`.

Create the transfer function $G(z) = \frac{z}{z^2 - 2z - 6}$ with a sampling time of 0.1 s.

```
num = [1 0];  
den = [1 -2 -6];  
Ts = 0.1;  
G = tf(num,den,Ts)
```

`num` and `den` are the numerator and denominator polynomial coefficients in descending powers of z . `G` is a `tf` model object.

Tip Create a discrete-time `zpk`, `ss`, and `frd` models in a similar way by appending a sampling period to the input arguments. For examples, see the reference pages for those commands.

The sampling time is stored in the `Ts` property of `G`. Access `Ts`, using dot notation:

```
G.Ts
```

More About

- “What Are Model Objects?” on page 1-2
- “Models with Fixed Coefficients” on page 1-18

Discrete-Time Proportional-Integral-Derivative (PID) Controller

Discrete-Time PID Controller Representations

Discrete-time PID controllers are expressed by the following formulas.

Form	Formula
Parallel	$C = K_p + K_i IF(z) + \frac{K_d}{T_f + DF(z)},$ <p>where:</p> <ul style="list-style-type: none"> • K_p = proportional gain • K_i = integrator gain • K_d = derivative gain • T_f = derivative filter time
Standard	$C = K_p \left(1 + \frac{1}{T_i} IF(z) + \frac{T_d}{\frac{T_d}{N} + DF(z)} \right),$ <p>where:</p> <ul style="list-style-type: none"> • K_p = proportional gain • T_i = integrator time • T_d = derivative time • N = derivative filter constant

$IF(z)$ and $DF(z)$ are the discrete integrator formulas for the integrator and derivative filter, respectively. Use the IFormula and DFormula properties of

the `pid` or `pidstd` model objects to set the $IF(z)$ and $DF(z)$ formulas. The next table shows available formulas for $IF(z)$ and $DF(z)$. T_s is the sample time.

IFormula or DFormula	IF(z) or DF(z)
ForwardEuler (default)	$\frac{T_s}{z-1}$
BackwardEuler	$\frac{T_s z}{z-1}$
Trapezoidal	$\frac{T_s}{2} \frac{z+1}{z-1}$

If you do not specify a value for IFormula, DFormula, or both, ForwardEuler is used by default.

Create Discrete-Time Standard-Form PID Controller

This example shows how to create a standard-form discrete-time Proportional-Integral-Derivative (PID) controller that has $K_p = 29.5$, $T_i = 1.13$, $T_d = 0.15$, $N = 2.3$, and sample time $T_s = 0.1$:

```
C = pidstd(29.5,1.13,0.15,2.3,0.1,...
          'IFormula','Trapezoidal','DFormula','BackwardEuler')
```

This command creates a `pidstd` model with $IF(z) = \frac{T_s}{2} \frac{z+1}{z-1}$ and

$$DF(z) = \frac{T_s z}{z-1}.$$

You can set the discrete integrator formulas for a parallel-form controller in the same way, using `pid`.

More About

- “What Are Model Objects?” on page 1-2
- “PID Controllers” on page 1-23

MIMO Model Creation

How to create multi-input, multi-output (MIMO) models.

In this section...

“MIMO Transfer Function Model” on page 2-14

“MIMO State-Space Model” on page 2-15

“MIMO Descriptor State-Space Model” on page 2-17

“MIMO Frequency Response Data Model” on page 2-18

“Select Input/Output Pairs in MIMO Models” on page 2-20

MIMO Transfer Function Model

This example shows how to create a multi-input, multi-output (MIMO) transfer function model by concatenating single-input, single-output (SISO) transfer function models.

To create the one-input, two-output MIMO transfer function:

$$G(s) = \begin{bmatrix} \frac{s-1}{s+1} \\ \frac{s+2}{s^2+4s+5} \end{bmatrix},$$

perform the following steps:

- 1 Create SISO transfer functions for each channel.

```
g11 = tf([1 -1],[1 1]);
g21 = tf([1 2],[1 4 5]);
```

Tip Use `zpk` instead of `tf` to create MIMO transfer functions in factorized form.

2 Concatenate the transfer functions.

$$G = [g_{11}; g_{21}];$$

More About

- “What Are Model Objects?” on page 1-2
- “Transfer Functions” on page 1-19

MIMO State-Space Model

This example shows how to create a MIMO state-space model using `ss`.

You create a MIMO state-space model in the same way as you create a SISO state-space model. The only difference between the SISO and MIMO cases is the dimensions of the state-space matrices. The dimensions of the B , C , and D matrices increase with the numbers of inputs and outputs as shown in the following illustration.

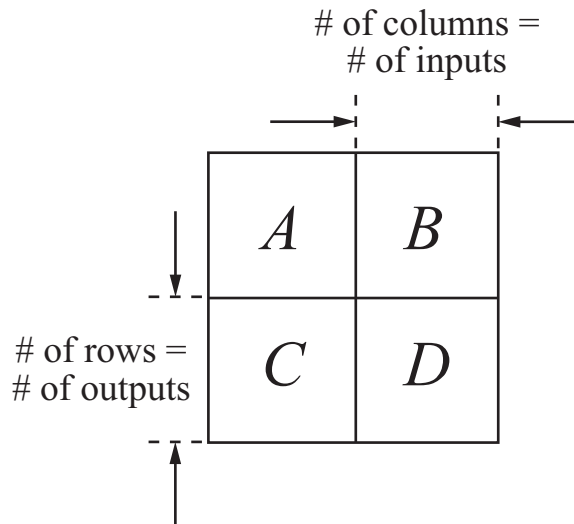

In this example, you create a state-space model for a rotating body with inertia tensor J , damping force F , and three axes of rotation, related as:

$$J \frac{d\omega}{dt} + F\omega = T$$
$$y = \omega.$$

The system input T is the driving torque. The output y is the vector of angular velocities of the rotating body.

To express this system in state-space form:

$$\frac{dx}{dt} = Ax + Bu$$
$$y = Cx + Du$$

rewrite it as:

$$\frac{d\omega}{dt} = -J^{-1}F\omega + J^{-1}T$$
$$y = \omega.$$

Then the state-space matrices are:

$$A = -J^{-1}F, \quad B = J^{-1}, \quad C = I, \quad D = 0.$$

To create this model, enter the following commands:

```
J = [8 -3 -3; -3 8 -3; -3 -3 8];  
F = 0.2*eye(3);  
A = -J\F;  
B = inv(J);  
C = eye(3);  
D = 0;  
sys_mimo = ss(A,B,C,D);
```

These commands assume that J is the inertia tensor of a cube rotating about its corner, and the damping force has magnitude 0.2.

`sys_mimo` is an ss model.

More About

- “What Are Model Objects?” on page 1-2
- “State-Space Models” on page 1-20

MIMO Descriptor State-Space Model

This example shows how to create a continuous-time descriptor (implicit) state-space model using `dss`.

Note This example uses the same rotating-body system shown in “MIMO State-Space Model” on page 2-15, where you inverted the inertia matrix J to obtain the value of the B matrix. If J is poorly-conditioned for inversion, you can instead use a descriptor (implicit) state-space model.

A *descriptor (implicit) state-space model* is of the form:

$$E \frac{dx}{dt} = Ax + Bu$$

$$y = Cx + Du$$

Create a state-space model for a rotating body with inertia tensor J , damping force F , and three axes of rotation, related as:

$$J \frac{d\omega}{dt} + F\omega = T$$

$$y = \omega.$$

The system input T is the driving torque. The output y is the vector of angular velocities of the rotating body. You can write this system as a descriptor state-space model having the following state-space matrices:

$$A = -F, \quad B = I, \quad C = I, \quad D = 0, \quad E = J.$$

To create this system, enter:

$$J = [8 \ -3 \ -3; \ -3 \ 8 \ -3; \ -3 \ -3 \ 8];$$

```
F = 0.2*eye(3);  
A = -F;  
B = eye(3);  
C = eye(3);  
D = 0;  
E = J;  
sys_mimo = dss(A,B,C,D,E)
```

These commands assume that J is the inertia tensor of a cube rotating about its corner, and the damping force has magnitude 0.2.

sys is an ss model with a nonempty E matrix.

More About

- “What Are Model Objects?” on page 1-2
- “State-Space Models” on page 1-20

MIMO Frequency Response Data Model

This example shows how to create a MIMO frequency-response model using `frd`.

Frequency response data for a MIMO system includes a vector of complex response data for each of the input/output (I/O) pair of the system. Thus, if you measure the frequency response of each I/O pair your system at a set of test frequencies, you can use the data to create a frequency response model:

1 Load frequency response data in `AnalyzerDataMIMO.mat`.

```
load AnalyzerDataMIMO H11 H12 H21 H22 freq
```

This command loads the data into the MATLAB workspace as five column vectors `H11`, `H12`, `H21`, `H22`, and `freq`. The vector `freq` contains 100 test frequencies. The other four vectors contain the corresponding complex-valued frequency response of each I/O pair of a two-input, two-output system.

Tip To inspect these variables, enter:

```
whos H11 H12 H21 H22 freq
```

2 Organize the data into a three-dimensional array.

```
Hresp = zeros(2,2,length(freq));  
Hresp(1,1,:) = H11;  
Hresp(1,2,:) = H12;  
Hresp(2,1,:) = H21;  
Hresp(2,2,:) = H22;
```

The dimensions of `Hresp` are the number of outputs, number of inputs, and the number of frequencies for which there is response data. `Hresp(i,j,:)` contains the frequency response from input `j` to output `i`.

3 Create a frequency-response model.

```
H = frd(Hresp,freq);
```

`sys` is an `frd` model object, which is a data container for representing frequency response data.

You can use `frd` models with many frequency-domain analysis commands. For example, visualize the response of this two-input, two-output system using `bode`.

Tip By default, the `frd` command assumes that the frequencies are in radians/second. To specify different frequency units, use the `TimeUnit` and `FrequencyUnit` properties of the `frd` model object. For example:

```
sys = frd(Hresp,freq,'TimeUnit','min','FrequencyUnit','rad/TimeUnit')
```

sets the frequency units to in radians/minute.

More About

- “What Are Model Objects?” on page 1-2
- “Frequency Response Data (FRD) Models” on page 1-22

Select Input/Output Pairs in MIMO Models

This example shows how to select the response from the first input to the second output of a MIMO model.

- 1** Create a two-input, one-output transfer function.

```
N = {[1 -1],[1]};[1 2],[3 1 4]};  
D = [1 1 10];  
H = tf(N,D)
```

Note For more information about using cell arrays to create MIMO transfer functions, see the `tf` reference page.

- 2** Select the response from the second input to the output of H.

To do this, use MATLAB array indexing.

```
H12 = H(1,2)
```

For any MIMO system H, the index notation $H(i, j)$ selects the response from the j th input to the i th output.

Models with Time Delays

How to create models that include time delays.

In this section...

“Modeling Time Delays” on page 2-21

“First Order Plus Dead Time Model” on page 2-22

“Input and Output Delay in State-Space Model” on page 2-23

“Transport Delay in MIMO Transfer Function” on page 2-25

“Closing Feedback Loops with Time Delays” on page 2-26

“Discrete-Time Transfer Function with Time Delay” on page 2-29

“Time-Delay Approximation” on page 2-29

“Time-Delay Approximation in Continuous-Time Open-Loop Model” on page 2-30

“Time-Delay Approximation in Continuous-Time Closed-Loop Model” on page 2-34

“Approximate Different Delays with Different Approximation Orders” on page 2-39

“Convert Time Delay to Factors of $1/z$ in Discrete-Time Model” on page 2-41

“Fractional Time-Delay Approximation in Discrete-Time Model” on page 2-43

“Frequency Response Data (FRD) Model with Time Delay” on page 2-45

“Internal Delays” on page 2-47

Modeling Time Delays

Use the following model properties to represent time delays in linear systems.

- `InputDelay`, `OutputDelay` — Time delays at system inputs or outputs
- `ioDelay`, `InternalDelay` — Time delays that are internal to the system

In discrete-time models, these properties are constrained to integer values that represent delays expressed as integer multiples of the sampling time. To approximate discrete-time models with delays that are a fractional multiple of the sampling time, use `thiran`.

First Order Plus Dead Time Model

This example shows how to create a first order plus dead time model using the `InputDelay` or `OutputDelay` properties of `tf`.

To create the following first-order transfer function with a 2.1 s time delay:

$$G(s) = e^{-2.1s} \frac{1}{s + 10},$$

enter:

```
G = tf(1,[1 10], 'InputDelay',2.1)
```

where `InputDelay` specifies the delay at the input of the transfer function.

Tip You can use `InputDelay` with `zpk` the same way as with `tf`:

```
G = zpk([], -10,1, 'InputDelay',2.1)
```

For SISO transfer functions, a delay at the input is equivalent to a delay at the output. Therefore, the following command creates the same transfer function:

```
G = tf(1,[1 10], 'OutputDelay',2.1)
```

Use dot notation to examine or change the value of a time delay. For example, change the time delay to 3.2 as follows:

```
G.OutputDelay = 3.2;
```

To see the current value, enter:

```
G.OutputDelay
```

ans =

3.2000

Tip An alternative way to create a model with a time delay is to specify the transfer function with the delay as an expression in s :

1 Create a transfer function model for the variable s .

```
s = tf('s');
```

2 Specify $G(s)$ as an expression in s .

```
G = exp(-2.1*s)/(s+10);
```

More About

- “What Are Model Objects?” on page 1-2
- “Transfer Functions” on page 1-19

Input and Output Delay in State-Space Model

This example shows how to create state-space models with delays at the inputs and outputs, using the `InputDelay` or `OutputDelay` properties of `ss`.

Create a state-space model describing the following one-input, two-output system:

$$\frac{dx(t)}{dt} = -2x(t) + 3u(t-1.5)$$

$$y(t) = \begin{bmatrix} x(t-0.7) \\ -x(t) \end{bmatrix}.$$

This system has an input delay of 1.5. The first output has an output delay of 0.7, and the second output is not delayed.

Note In contrast to SISO transfer functions, input delays are not equivalent to output delays for state-space models. Shifting a delay from input to output in a state-space model requires introducing a time shift in the model states. For example, in the model of this example, defining $T = t - 1.5$ and $X(T) = x(T + 1.5)$ results in the following equivalent system:

$$\frac{dX(T)}{dT} = -2X(T) + 3u(T)$$
$$y(T) = \begin{bmatrix} X(T - 2.2) \\ -X(T - 1.5) \end{bmatrix}.$$

All of the time delays are on the outputs, but the new state variable X is time-shifted relative to the original state variable x . Therefore, if your states have physical meaning, or if you have known state initial conditions, consider carefully before shifting time delays between inputs and outputs.

To create this system:

1 Define the state-space matrices.

$$\begin{aligned} A &= -2; \\ B &= 3; \\ C &= [1; -1]; \\ D &= 0; \end{aligned}$$

2 Create the model.

$$G = \text{ss}(A,B,C,D, 'InputDelay', 1.5, 'OutputDelay', [0.7;0])$$

G is a ss model.

Tip Use `delays` to create state-space models with more general combinations of input, output, and state delays, of the form:

$$\frac{dx}{dt} = Ax(t) + Bu(t) + \sum_{j=1}^N (A_j x(t - t_j) + B_j u(t - t_j))$$

$$y(t) = Cx(t) + Du(t) + \sum_{j=1}^N (C_j x(t - t_j) + D_j u(t - t_j))$$

More About

- “What Are Model Objects?” on page 1-2
- “State-Space Models” on page 1-20

Transport Delay in MIMO Transfer Function

This example shows how to create a MIMO transfer function with different transport delays for each input-output (I/O) pair.

Create the MIMO transfer function:

$$H(s) = \begin{bmatrix} e^{-0.1} \frac{2}{s} & e^{-0.3} \frac{s+1}{s+10} \\ 10 & e^{-0.2} \frac{s-1}{s+5} \end{bmatrix}.$$

Time delays in MIMO systems can be specific to each I/O pair, as in this example. You cannot use `InputDelay` and `OutputDelay` to model I/O-specific transport delays. Instead, use `ioDelay` to specify the transport delay across each I/O pair.

To create this MIMO transfer function:

- 1 Create a transfer function model for the variable `s`.

```
s = tf('s');
```

- 2** Use the variable s to specify the transfer functions of H without the time delays.

$$H = [2/s \ (s+1)/(s+10); \ 10 \ (s-1)/(s+5)];$$

- 3** Specify the `ioDelay` property of H as an array of values corresponding to the transport delay for each I/O pair.

$$H.ioDelay = [0.1 \ 0.3; \ 0 \ 0.2];$$

H is a two-input, two-output `tf` model. Each I/O pair in H has the time delay specified by the corresponding entry in `tau`.

Closing Feedback Loops with Time Delays

This example shows how internal delays arise when you interconnect models that have input, output, or transport time delays.

Create a model of the following control architecture:

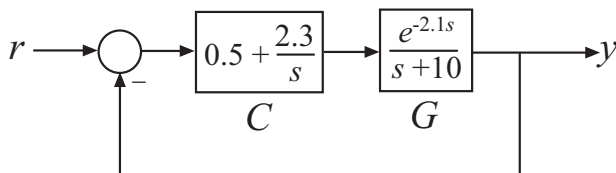

G is the plant model, which has an input delay. C is a proportional-integral (PI) controller.

To create a model representing the closed-loop response of this system:

- 1** Create the plant G and the controller C .

$$G = tf(1,[1 \ 10], 'InputDelay', 2.1);$$

$$C = pid(0.5, 2.3);$$

C has a proportional gain of 0.5 and an integral gain of 2.3.

- 2** Use feedback to compute the closed-loop response from r to y .

$$T = feedback(C*G, 1);$$

The time delay in T is not an input delay as it is in G . Because the time delay is internal to the closed-loop system, the software returns T as an `ss` model with an *internal time delay* of 2.1 seconds.

Note In addition to `feedback`, any system interconnection function (including `parallel` and `series`) can give rise to internal delays.

T is an exact representation of the closed-loop response, not an approximation. To access the internal delay value, enter:

```
T.InternalDelay
```

A step plot of T confirms the presence of the time delay:

```
step(T)
```

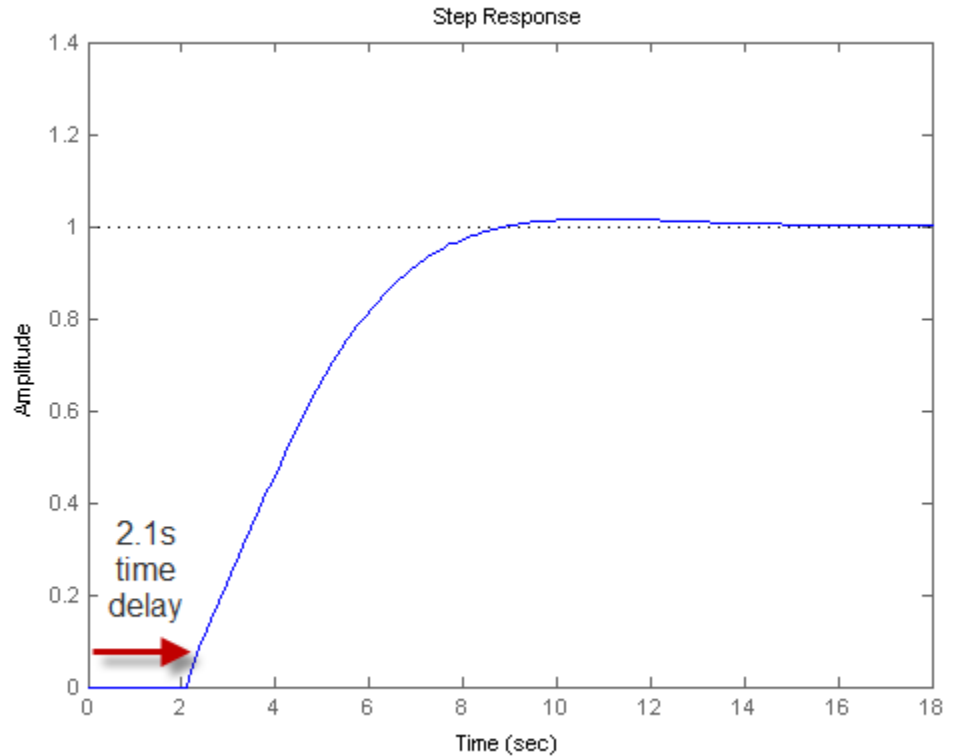

Note Most analysis commands, such as `step`, `bode` and `margin`, support models with internal delays.

The internal time delay is stored in the `InternalDelay` property of `T`. Use dot notation to access `InternalDelay`. For example, to change the internal delay to 3.5 seconds, enter:

```
T.InternalDelay = 3.5
```

You cannot modify the number of internal delays because they are structural properties of the model.

More About

- “Internal Delays” on page 2-47

Discrete-Time Transfer Function with Time Delay

This example shows how to create a discrete-time transfer function with a time delay.

Specify time delays for discrete-time models in the same way as for continuous-time models, except for discrete-time models, delay values must be integer multiples of the sampling time. For example, create the following first-order transfer function, with a sampling time of $T_s = 0.1$ s:

$$H(z) = z^{-25} \frac{2}{z - 0.95}.$$

```
H = tf(2,[1 -0.95],0.1,'InputDelay',25)
```

Setting `InputDelay` to 25 results in a delay of 25 sampling periods.

Tip Use `thiran` to approximate discrete-time models with delays that are a fractional multiple of the sampling time.

Time-Delay Approximation

Many control design algorithms cannot handle time delays directly. For example, techniques such as root locus, LQG, and pole placement do not work properly if time delays are present. A common technique is to replace delays with all-pass filters that approximate the delays.

To approximate time delays in continuous-time models, use the `pade` command to compute a Padé approximation. The Padé approximation is valid only at low frequencies, and provides better frequency-domain approximation than time-domain approximation. It is therefore important to compare the

true and approximate responses to choose the right approximation order and check the approximation validity.

For discrete-time models, use `absorbDelay` to convert a time delay to factors of $1/z$ where the time delay is an integer multiple of the sampling time. Use `thiran` to approximate fractional time delays.

Related Examples

- “Time-Delay Approximation in Continuous-Time Open-Loop Model” on page 2-30
- “Time-Delay Approximation in Continuous-Time Closed-Loop Model” on page 2-34
- “Approximate Different Delays with Different Approximation Orders” on page 2-39
- “Convert Time Delay to Factors of $1/z$ in Discrete-Time Model” on page 2-41
- “Fractional Time-Delay Approximation in Discrete-Time Model” on page 2-43

Time-Delay Approximation in Continuous-Time Open-Loop Model

This example shows how to approximate delays in a continuous-time open-loop system using `pade`.

Padé approximation is helpful when using analysis or design tools that do not support time delays.

- 1** Create sample open-loop system with an output delay.

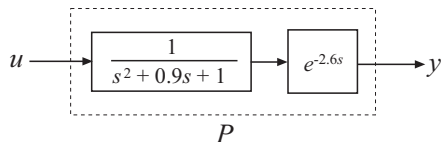

```
s = tf('s');
P = exp(-2.6*s)/(s^2+0.9*s+1);
```

P is a second-order transfer function (tf) object with a time delay.

- 2** Compute the first-order Padé approximation of P.

```
Pnd1 = pade(P,1)
```

```
Pnd1 =
```

$$\frac{-s + 0.7692}{s^3 + 1.669 s^2 + 1.692 s + 0.7692}$$

Continuous-time transfer function.

This command replaces all time delays in P with a first-order approximation. Therefore, Pnd1 is a third-order transfer function with no delays.

- 3** Compare the frequency response of the original and approximate models using bodeplot.

```
h = bodeoptions;
h.PhaseMatching = 'on';
bodeplot(P, '-b', Pnd1, '-.r', {0.1, 10}, h)
legend('Exact delay', 'First-Order Pade', 'Location', 'SouthWest')
```

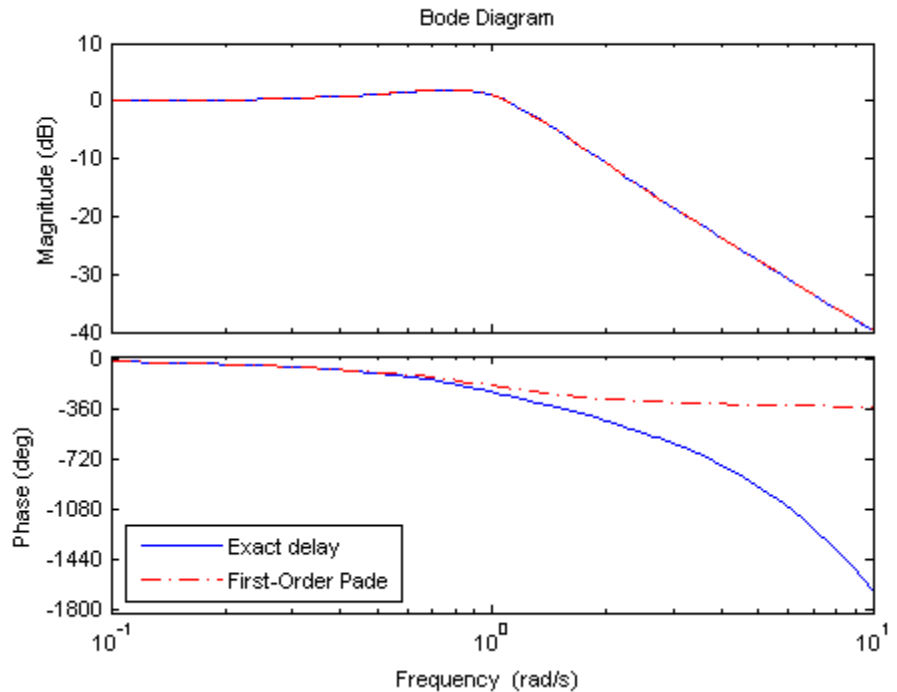

The magnitude of P and Pnd1 match exactly. However, the phase of Pnd1 deviates from the phase of P beyond approximately 1 rad/s.

- 4 Increase the Padé approximation order to extend the frequency band in which the phase approximation is good.

```
Pnd3 = pade(P,3);
```

- 5 Compare the frequency response of P, Pnd1 and Pnd3.

```
bodeplot(P, '-b', Pnd3, '-.r', Pnd1, ':k', {0.1 10}, h)
legend('Exact delay', 'Third-Order Pade', 'First-Order Pade', ...
      'Location', 'SouthWest')
```

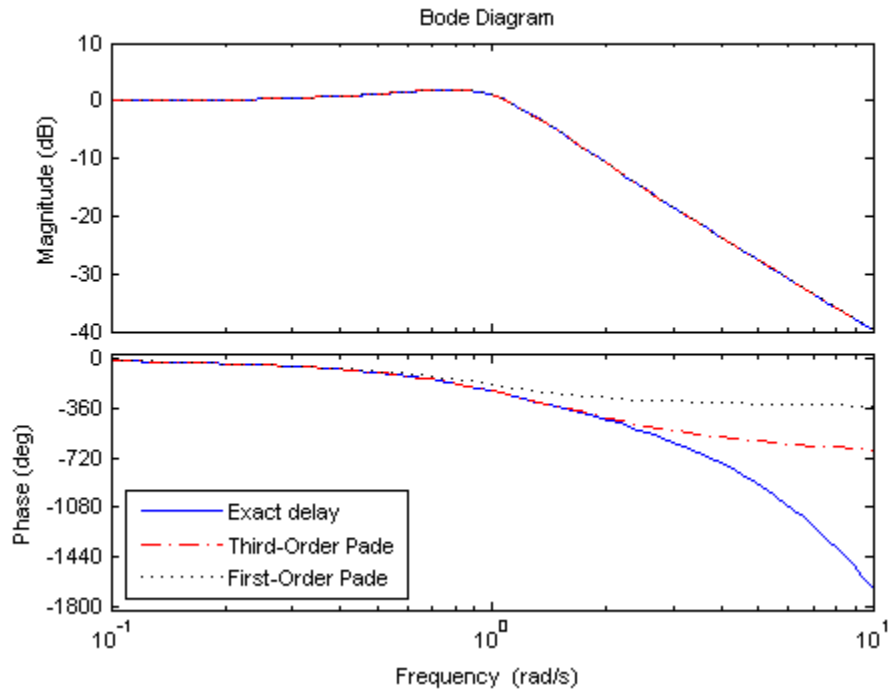

The phase approximation error is reduced by using a third-order Padé approximation.

- 6** Compare the time domain responses of the original and approximated systems using step.

```
step(P, '-b', Pnd3, '-.r', Pnd1, ':k')
legend('Exact delay', 'Third-Order Padé', 'First-Order Padé', ...
      'Location', 'Southeast')
```

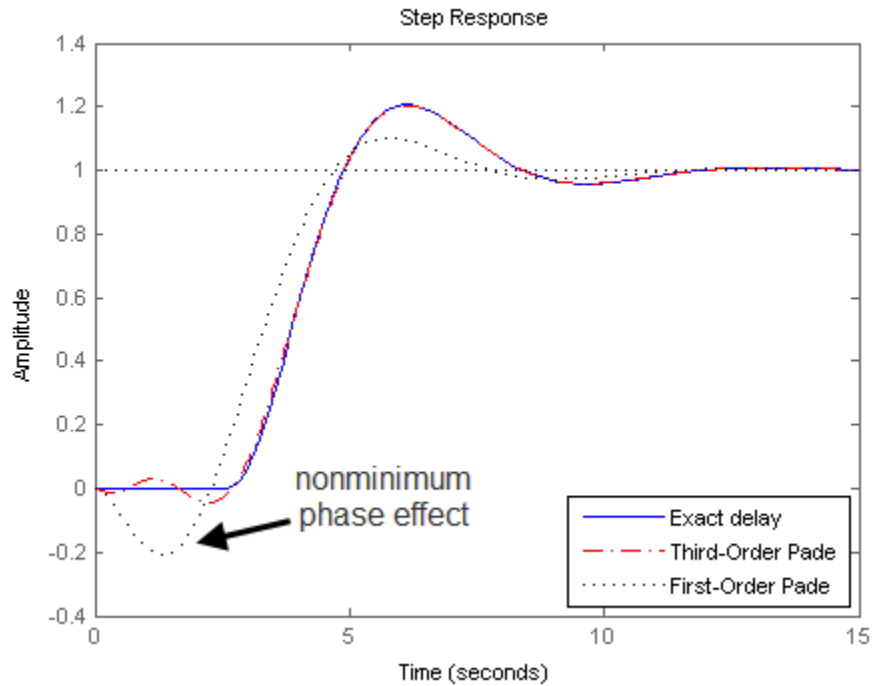

Using the Padé approximation introduces a nonminimum phase artifact (“wrong way” effect) in the initial transient response. The effect is reduced in the higher-order approximation.

Note Using too high an approximation order may result in numerical issues and possibly unstable poles. Therefore, avoid Padé approximations with order $N > 10$.

Time-Delay Approximation in Continuous-Time Closed-Loop Model

This example shows how to approximate delays in a continuous-time closed-loop system with internal delays, using `pade`.

Padé approximation is helpful when using analysis or design tools that do not support time delays.

- 1 Create sample continuous-time closed-loop system with an internal delay.

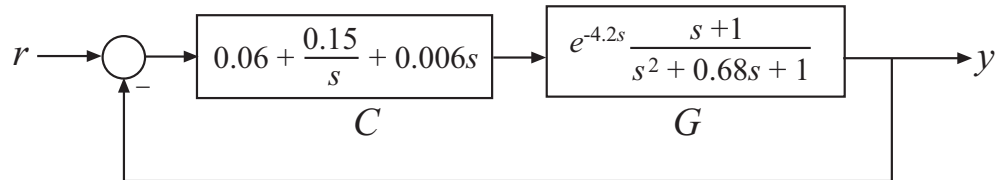

Construct a model Tc1 of the closed-loop transfer function from r to y.

```
s = tf('s');
G = (s+1)/(s^2+.68*s+1)*exp(-4.2*s);
C = pid(0.06,0.15,0.006);
Tc1 = feedback(G*C,1);
```

Examine the internal delay of Tc1.

```
Tc1.InternalDelay
```

```
ans =

    4.2000
```

- 2 Compute the first-order Padé approximation of Tc1.

```
Tnd1 = pade(Tc1,1);
```

Tnd1 is a state-space (ss) model with no delays.

- 3 Compare the frequency response of the original and approximate models.

```
h = bodeoptions;
h.PhaseMatching = 'on';
bodeplot(Tc1, '-b', Tnd1, '-.r', {.1, 10}, h);
legend('Exact delay', 'First-Order Pade', 'Location', 'SouthWest');
```

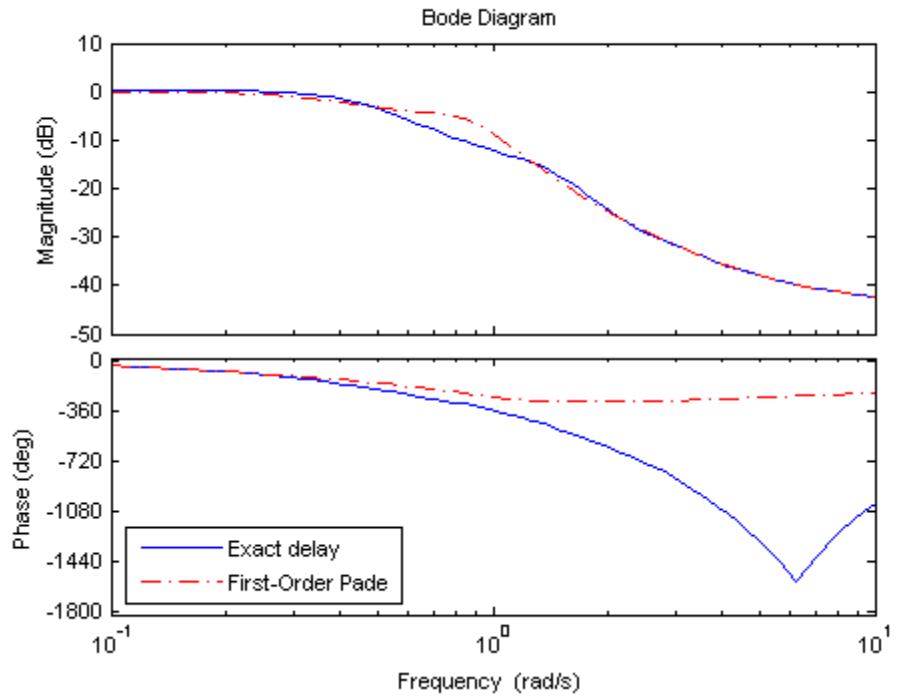

The magnitude and phase approximation errors are significant beyond 1 rad/s.

4 Compare the time domain response of Tc1 and Tnd1 using step.

```
step(Tc1, '-b', Tnd1, '-.r');
legend('Exact delay', 'First-Order Pade', 'Location', 'SouthEast');
```

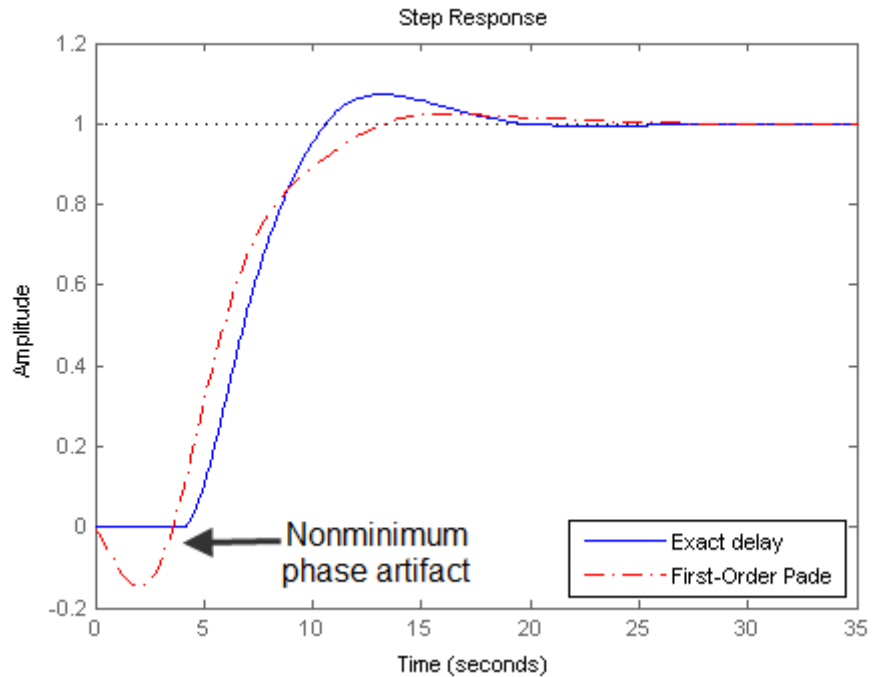

Using the Padé approximation introduces a nonminimum phase artifact (“wrong way” effect) in the initial transient response.

- 5** Increase the Padé approximation order to see if this will extend the frequency with good phase and magnitude approximation.

```
Tnd3 = pade(Tc1,3);
```

- 6** Observe the behavior of the third-order Padé approximation of Tc1. Compare the frequency response of Tc1 and Tnd3.

```
bode(Tc1, '-b', Tnd3, '-.r', Tnd1, '--k', {.1, 10}, h);
legend('Exact delay', 'Third-Order Padé', 'First-Order Padé', ...
      'Location', 'SouthWest');
```

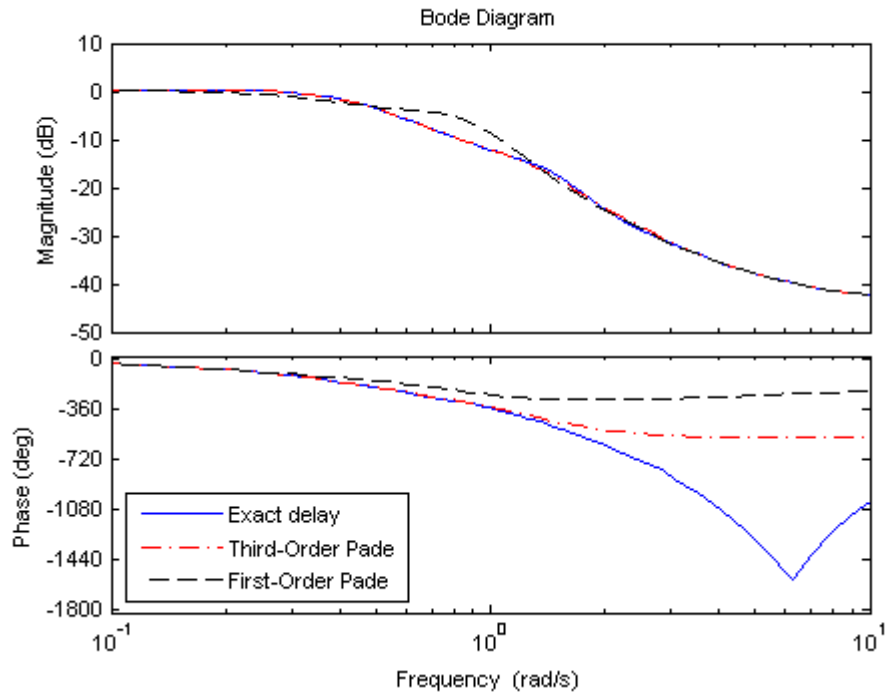

The magnitude and phase approximation errors are reduced when a third-order Padé approximation is used.

Increasing the Padé approximation order extends the frequency band where the approximation is good. However, too high an approximation order may result in numerical issues and possibly unstable poles. Therefore, avoid Padé approximations with order $N > 10$.

More About

- “Internal Delays” on page 2-47

Approximate Different Delays with Different Approximation Orders

This example shows how to specify different Padé approximation orders to approximate internal and output delays in a continuous-time open-loop system.

- 1 Load sample continuous-time open-loop system that contains internal and output time delays.

```
load PadeApproximation1 sys;
```

`sys` is a second-order continuous-time `ss` model with internal delay 3.4 s and output delay 1.5 s.

Tip Enter `get(sys)` for more properties of `sys`.

- 2 Use `pade` to compute a third-order approximation of the internal delay and a first-order approximation of the output delay.

```
P13 = pade(sys,inf,1,3);
```

The three input arguments following `sys` specify the approximation orders of any input, output, and internal delays of `sys`, respectively. `inf` specifies that a delay is not to be approximated. The approximation orders for the output and internal delays are one and three respectively.

`P13` is a sixth-order continuous-time `ss` model with no delays.

- 3 (Optional) For comparison, approximate only the internal delay of `sys`, leaving the output delay intact.

```
P3 = pade(sys,inf,inf,3);
```

`P3` is a fifth-order continuous-time `ss` model with an output delay of 1.5 s. The internal delay is approximated and absorbed into the state-space matrices.

- 4 (Optional) Compare the frequency response of the exact and approximated systems. sys, P13, P3.

```
h = bodeoptions;  
h.PhaseMatching = 'on';  
bode(sys,'b-',P13,'r-.',P3,'k--',h,{.01,10});  
legend('Exact Output and Internal Time Delays',...  
      'Pade Approximation - First-order Output, ...  
      Third-order Internal Delays',...  
      'Pade Approximation - Third-order Internal Delay',...  
      'location','SouthWest')
```

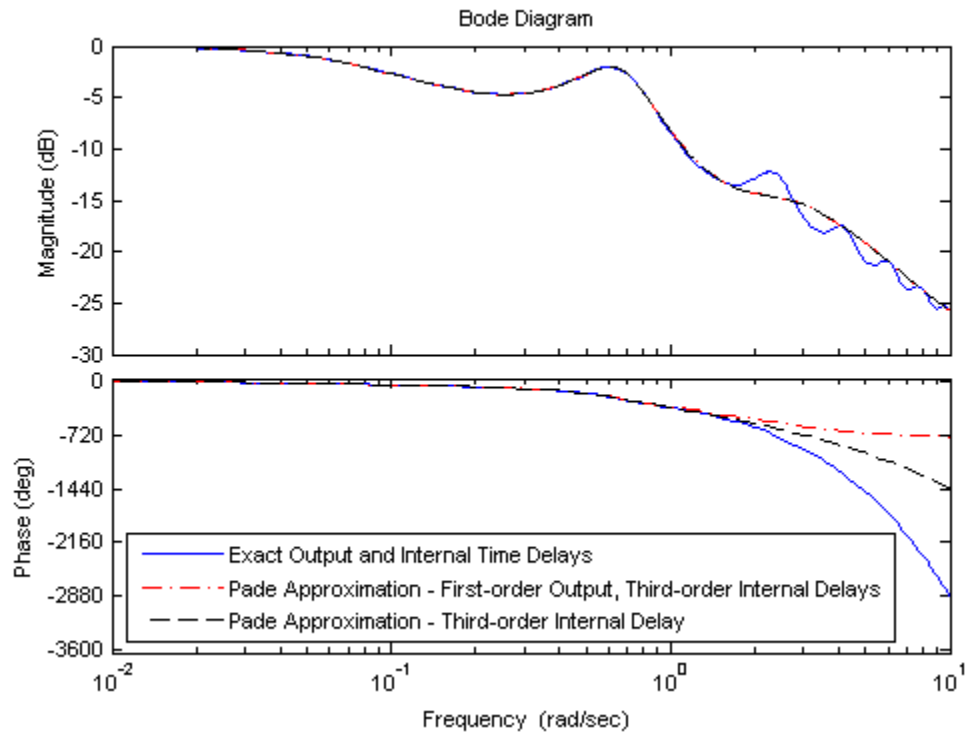

Convert Time Delay to Factors of $1/z$ in Discrete-Time Model

This example shows how to convert a time delay in a discrete-time model to factors of $1/z$ using `absorbDelay`.

In a discrete-time model, a time delay of one sampling interval is equivalent to a factor of $1/z$ (a pole at $z = 0$) in the model. Therefore, time delays stored in the `InputDelay`, `OutputDelay`, or `ioDelay` properties of a discrete-time model can be rewritten in the model dynamics by rewriting them as poles at $z = 0$. However, the additional poles increase the order of the system. Particularly for large time delays, this can yield systems of very high order, leading to long computation times or numerical inaccuracies.

To illustrate how to eliminate time delays in a discrete-time closed-loop model, and to observe the effects of doing so, create the following closed-loop system:

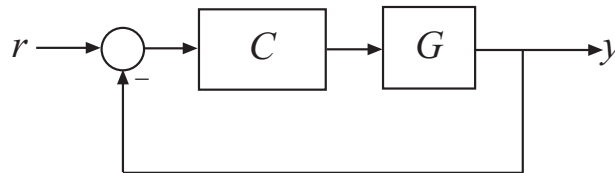

where G is a first-order discrete-time system with an input delay, and C is a PI controller.

```
G = ss(0.9,0.125,0.08,0,'Ts',0.01,'InputDelay',7);
C = pid(6,90,0,0,'Ts',0.01);
T = feedback(C*G,1);
```

Examine the order and internal delay of T .

```
order(T)
T.InternalDelay
```

```
ans =
```

```
2
```

```
ans =
```

7

T is a second-order state-space model with an internal delay of 7 time steps.

Use `absorbDelay` to replace the internal delay by z^{-7} .

```
Tnd = absorbDelay(T);
```

Examine the internal delay of Tnd.

```
Tnd.InternalDelay
```

```
ans =
```

```
Empty matrix: 0-by-1
```

Tnd has no internal delay, and the step response of Tnd exactly matches that of T:

```
step(T,Tnd)
```

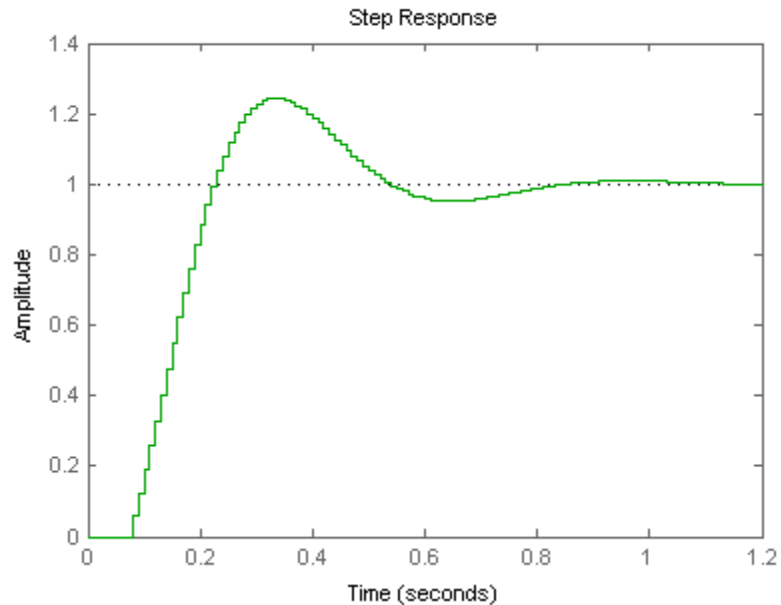

However, T_{nd} is a ninth-order model, due to the seven extra poles introduced by absorbing the seven-unit delay into the model.

```
order(Tnd)
```

```
ans =
```

```
9
```

Fractional Time-Delay Approximation in Discrete-Time Model

Use the `thiran` command to approximate a time delay that is a fractional multiple of the sampling time as a Thiran all-pass filter.

For a time delay of τ and a sampling time of T_s , the syntax `thiran(τ, T_s)` creates a discrete-time transfer function that is the product of two terms:

- A term representing the integer portion of the time delay as a pure line delay, $(1/z)^N$, where $N = \text{ceil}(\tau/T_s)$.
- A term approximating the fractional portion of the time delay ($\tau - NT_s$) as a Thiran all-pass filter.

Discretizing a Padé approximation does not guarantee good phase matching between the continuous-time delay and its discrete approximation. Using `thiran` to generate a discrete-time approximation of a continuous-time delay can yield much better phase matching. For example, the following figure shows the phase delay of a 10.2-second time delay discretized with a sample time of 1 s, approximated in three ways:

- a first-order Padé approximation, discretized using the `tustin` method of `c2d`
- an 11th-order Padé approximation, discretized using the `tustin` method of `c2d`
- an 11th-order Thiran filter

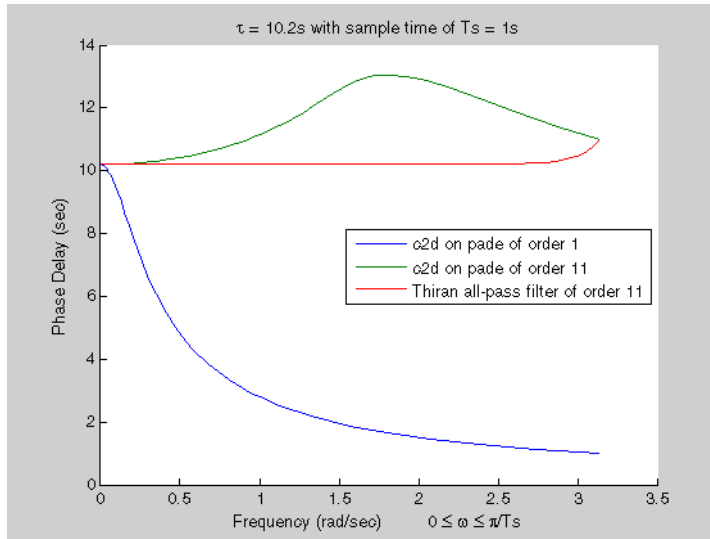

The Thiran filter yields the closest approximation of the 10.2-second delay.

See the `thiran` reference page for more information about Thiran filters.

Frequency Response Data (FRD) Model with Time Delay

This example shows that absorbing time delays into frequency response data can cause undesirable phase wrapping at high frequencies.

When you collect frequency response data for a system that includes time delays, you can absorb the time delay into the frequency response as a phase shift. Alternatively, if you are able to separate time delays from your measured frequency response, you can represent the delays using the `InputDelay`, `OutputDelay`, or `ioDelay` properties of the `frd` model object. The latter approach can give better numerical results, as this example illustrates.

The `frd` model `fsys` includes a transport delay of 2 s. Load the model into the MATLAB workspace and inspect the time delay with the following commands:

```
load frddelayexample fsys
fsys.ioDelay
```

A Bode plot of `fsys` shows the effect of the transport delay:

```
bodeplot(fsys)
```

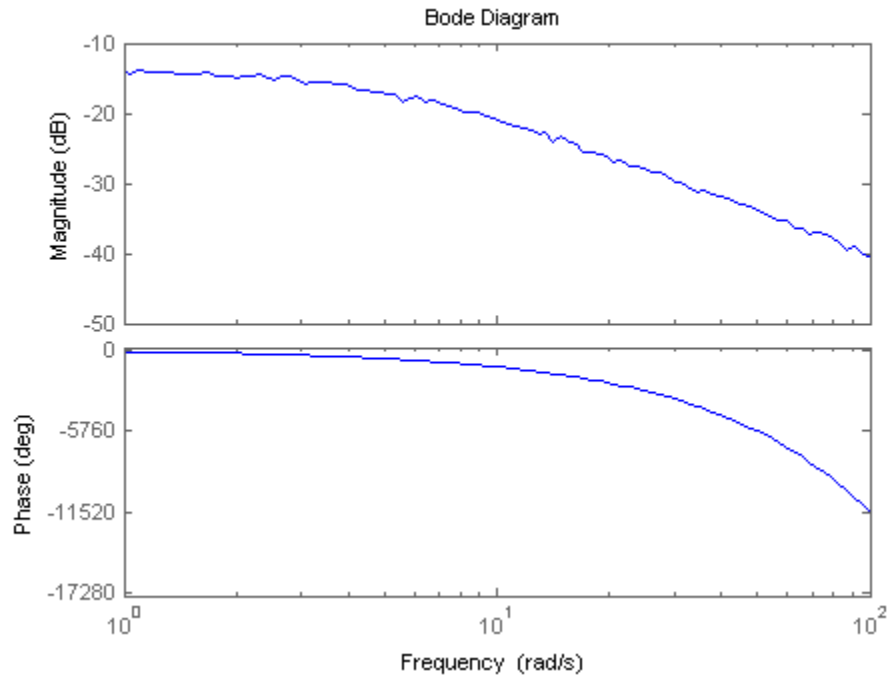

The transport delay `ioDelay = 2` introduces a rapid accumulation of phase with increasing frequency.

The `absorbDelay` command absorbs all time delays directly into the frequency response, resulting in an `frd` model with `ioDelay = 0`:

```
fsys2 = absorbDelay(fsys);  
fsys2.ioDelay
```

Comparing the two ways of representing the delay shows that absorbing the delay into the frequency response causes phase-wrapping.

```
bode(fsys, fsys2)
```

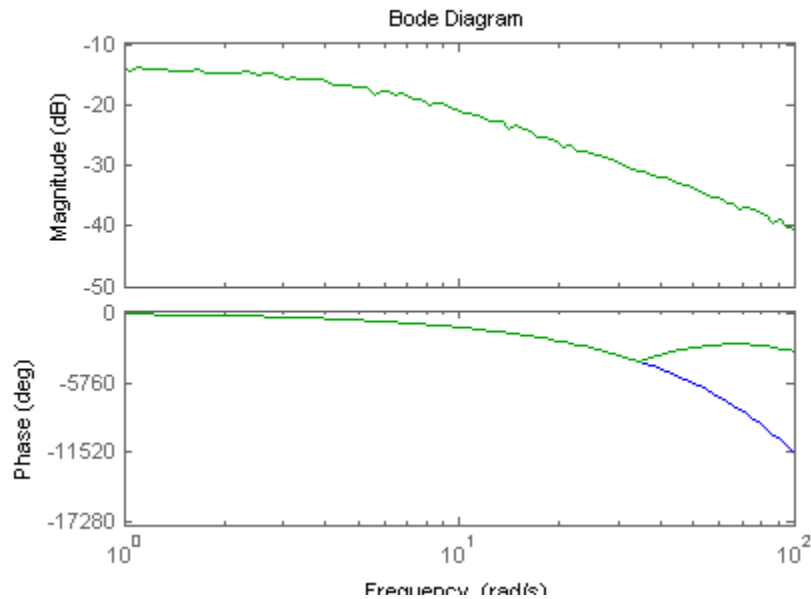
Phase wrapping can introduce numerical inaccuracy at high frequencies or where the frequency grid is sparse. For that reason, if your system takes the form $e^{-\tau s}G(s)$, you might get better results by measuring frequency response data for $G(s)$ and using `InputDelay`, `OutputDelay`, or `ioDelay` to model the time delay τ .

More About

- “Frequency Response Data (FRD) Models” on page 1-22

Internal Delays

Using the `InputDelay`, `OutputDelay`, and `ioDelay` properties, you can model simple processes with transport delays. However, these properties cannot model more complex situations, such as feedback loops with delays. In addition to the `InputDelay` and `OutputDelay` properties, state-space (ss) models have an `InternalDelay` property. This property lets you model the interconnection of systems with input, output, or transport delays, including feedback loops with delays. You can use `InternalDelay` property to

accurately model and analyze arbitrary linear systems with delays. Internal delays can arise from the following:

- Concatenating state-space models with input and output delays
- Feeding back a delayed signal
- Converting MIMO tf or zpk models with transport delays to state-space form

Using internal time delays, you can do the following:

- In continuous time, generate approximate-free time and frequency simulations, because delays do not have to be replaced by a Padé approximation. In continuous time, this allows for more accurate analysis of systems with long delays.
- In discrete time, keep delays separate from other system dynamics, because delays are not replaced with poles at $z = 0$, which boosts efficiency of time and frequency simulations for discrete-time systems with long delays.
- Use most Control System Toolbox functions.
- Test advanced control strategies for delayed systems. For example, you can implement and test an accurate model of a Smith predictor. See the example [Control of Processes with Long Dead Time: The Smith Predictor](#) .

Why Internal Delays Are Necessary

This example illustrates why input, output, and transport delays not enough to model all types of delays that can arise in dynamic systems. Consider the simple feedback loop with a 2 s. delay:

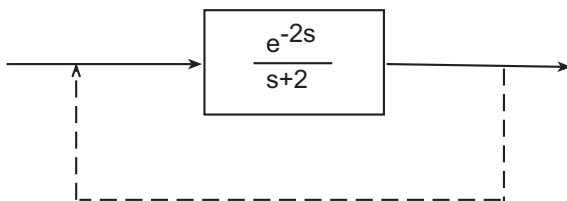

The closed-loop transfer function is

$$\frac{e^{-2s}}{s + 2 + e^{-2s}}$$

The delay term in the numerator can be represented as an output delay. However, the delay term in the denominator cannot. In order to model the effect of the delay on the feedback loop, the `InternalDelay` property is needed to keep track of internal coupling between delays and ordinary dynamics.

Typically, you do not create state-space models with internal delays directly, by specifying the A , B , C , and D matrices together with a set of internal delays. Rather, such models arise when you interconnect models having delays. There is no limitation on how many delays are involved and how the models are connected. For an example of creating an internal delay by closing a feedback loop, see “Closing Feedback Loops with Time Delays” on page 2-26.

Behavior of Models With Internal Delays

When you work with models having internal delays, be aware of the following behavior:

- When a model interconnection gives rise to internal delays, the software returns an `ss` model regardless of the interconnected model types. This occurs because only `ss` supports internal delays.
- The software fully supports feedback loops. You can wrap a feedback loop around any system with delays.
- When displaying the A , B , C , and D matrices, the software sets all delays to zero (creating a zero-order Padé approximation). This approximation occurs for the display only, and not for calculations using the model.

For some systems, setting delays to zero creates singular algebraic loops, which result in either improper or ill-defined, zero-delay approximations. For these systems:

- Entering `sys` returns only sizes for the matrices of a system named `sys`.
- Entering `sys.a` produces an error.

The limited display and the error do not imply a problem with the model `sys` itself.

Inside Time Delay Models

State-space objects use generalized state-space equations to keep track of internal delays. Conceptually, such models consist of two interconnected parts:

- An ordinary state-space model $H(s)$ with an augmented I/O set
- A bank of internal delays.

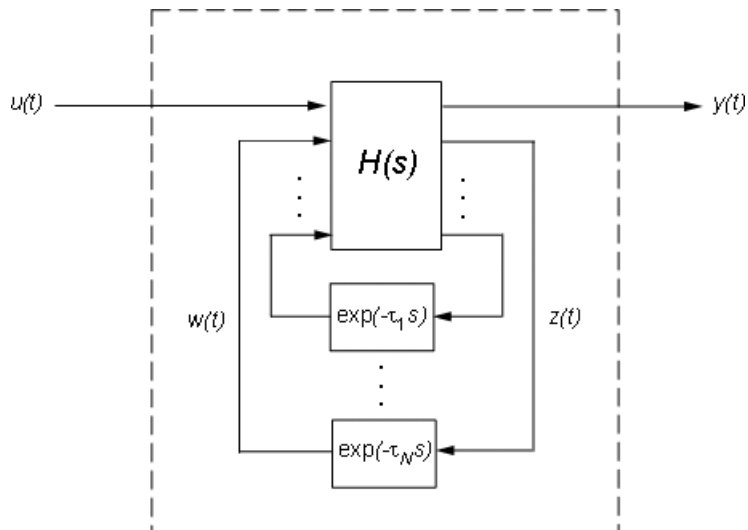

The corresponding state-space equations are:

$$\begin{aligned} \dot{x} &= Ax(t) + B_1u(t) + B_2w(t) \\ y(t) &= C_1x(t) + D_{11}u(t) + D_{12}w(t) \\ z(t) &= C_2x(t) + D_{21}u(t) + D_{22}w(t) \\ w_j(t) &= z(t - \tau_j), \quad j = 1, \dots, N \end{aligned}$$

You need not bother with this internal representation to use the tools. If, however, you want to extract H or the matrices A, B_1, B_2, \dots , you can use `getDelayModel`. For the example:

$$P = 5 * \exp(-3.4 * s) / (s + 1);$$

```
C = 0.1 * (1 + 1/(5*s));  
T = feedback(ss(P*C),1);  
[H,tau] = getDelayModel(T,'lft');  
size(H)
```

Note that H is a two-input, two-output model whereas T is SISO. The inverse operation (combining H and tau to construct T) is performed by `setDelayModel`.

See [1], [2] for details.

Functions That Support Internal Time Delays

The following commands support internal delays for both continuous- and discrete-time systems:

- All interconnection functions
- Time domain response functions—except for `impz` and `initial`
- Frequency domain functions—except for `norm`

Limitations on Functions that Support Internal Time Delays. The following commands support internal delays for both continuous- and discrete-time systems and have certain limitations:

- `allmargin`, `margin`—Uses interpolation, therefore these commands are only as precise as the fineness of the specified grid.
- `pole`, `zero`—Returns poles and zeros of the system with all delays set to zero.
- `ssdata`, `get`—If an SS model has internal delays, these commands return the A, B, C, and D matrices of the system with all internal delays set to zero. Use `getDelayModel` to access the internal state-space representation of models with internal delays.

Functions That Do Not Support Internal Time Delays

The following commands do not support internal time delays:

- System dynamics—`norm` and `isstable`

- Time-domain analysis—`initial` and `initialplot`
- Model simplification—`balreal`, `balred`, and `modred`
- Compensator design—`rlocus`, `lqg`, `lqry`, `lqrd`, `kalman`, `kalmd`, `lqgreg`, `lqgtrack`, `lqi`, and `augstate`.

To use these functions on a system with internal delays, use `pade` to approximate the internal delays. See “Time-Delay Approximation” on page 2-29.

References

[1] P. Gahinet and L.F. Shampine, "Software for Modeling and Analysis of Linear Systems with Delays," *Proc. American Control Conf.*, Boston, 2004, pp. 5600-5605

[2] L.F. Shampine and P. Gahinet, Delay-differential-algebraic Equations in Control Theory, *Applied Numerical Mathematics*, 56 (2006), pp. 574-588

Models with Parametric or Tunable Coefficients

In this section...

“Tunable Low-Pass Filter” on page 2-53

“Tunable Second-Order Filter” on page 2-54

“State-Space Model with Both Fixed and Tunable Parameters” on page 2-55

“Control System with Tunable Components” on page 2-56

Tunable Low-Pass Filter

This example shows how to create the low-pass filter $F = a/(s + a)$ with one tunable parameter a .

You cannot use `ltiblock.tf` to represent F , because the numerator and denominator coefficients of an `ltiblock.tf` block are independent. Instead, construct F using the tunable real parameter object `realp`.

- 1 Create a tunable real parameter.

```
a = realp('a',10);
```

The `realp` object `a` is a tunable parameter with initial value 10.

- 2 Use `tf` to create the tunable filter `F`:

```
F = tf(a,[1 a]);
```

`F` is a `genss` object which has the tunable parameter `a` in its `Blocks` property. You can connect `F` with other tunable or numeric models to create more complex models of control systems. For an example, see “Control System with Tunable Components” on page 2-56.

More About

- “Models with Tunable Coefficients” on page 1-27

Tunable Second-Order Filter

This example shows how to create a parametric model of the second-order filter:

$$F(s) = \frac{\omega_n^2}{s^2 + 2\zeta\omega_n s + \omega_n^2},$$

where the damping ζ and the natural frequency ω_n are tunable parameters.

- 1 Define the tunable parameters using `realp`.

```
wn = realp('wn',3);
zeta = realp('zeta',0.8);
```

`wn` and `zeta` are `realp` parameter objects, with initial values 3 and 0.8, respectively.

- 2 Create a model of the filter using the tunable parameters.

```
F = tf(wn^2,[1 2*zeta*wn wn^2])
```

The inputs to `tf` are the vectors of numerator and denominator coefficients expressed in terms of `wn` and `zeta`.

`F` is a `genss`. The property `F.Blocks` lists the two tunable parameters `wn` and `zeta`.

- 3 (Optional) Examine the number of tunable blocks in the model using `nblocks`.

```
nblocks(F)
```

This command returns the result:

```
ans =
```

```
6
```

`F` has two tunable parameters, but the parameter `wn` appears five times — twice in the numerator and three times in the denominator.

4 (Optional) Rewrite F for fewer occurrences of ω_n .

The second-order filter transfer function can be expressed as follows:

$$F(s) = \frac{1}{\left(\frac{s}{\omega_n}\right)^2 + 2\zeta\left(\frac{s}{\omega_n}\right) + 1}.$$

Use this expression to create the tunable filter:

```
F = tf(1, [(1/wn)^2 2*zeta*(1/wn) 1])
```

5 (Optional) Examine the number of tunable blocks in the new filter model.

```
nblocks(F)
```

This command returns the result:

```
ans =
```

```
4
```

In the new formulation, there are only three occurrences of the tunable parameter ω_n . Reducing the number of occurrences of a block in a model can improve performance time of calculations involving the model. However, the number of occurrences does not affect the results of tuning the model or sampling it for parameter studies.

More About

- “Models with Tunable Coefficients” on page 1-27

State-Space Model with Both Fixed and Tunable Parameters

This example shows how to create a state-space (genss) model having both fixed and tunable parameters.

Create a state-space model having the following state-space matrices:

$$A = \begin{bmatrix} 1 & a+b \\ 0 & ab \end{bmatrix}, \quad B = \begin{bmatrix} -3.0 \\ 1.5 \end{bmatrix}, \quad C = [0.3 \ 0], \quad D = 0,$$

where a and b are tunable parameters, whose initial values are -1 and 3 , respectively.

1 Create the tunable parameters using `realp`.

```
a = realp('a', -1);  
b = realp('b', 3);
```

2 Define a generalized matrix using algebraic expressions of a and b .

```
A = [1 a+b; 0 a*b]
```

A is a generalized matrix whose `Blocks` property contains a and b . The initial value of A is $M = [1 \ 2; 0 \ -3]$, from the initial values of a and b .

3 Create the fixed-value state-space matrices.

```
B = [-3.0; 1.5];  
C = [0.3 0];  
D = 0;
```

4 Use `ss` to create the state-space model.

```
sys = ss(A,B,C,D)
```

`sys` is a generalized LTI model (`genss`) with tunable parameters a and b .

More About

- “Models with Tunable Coefficients” on page 1-27

Control System with Tunable Components

This example shows how to create a tunable model of the control system in the following illustration.

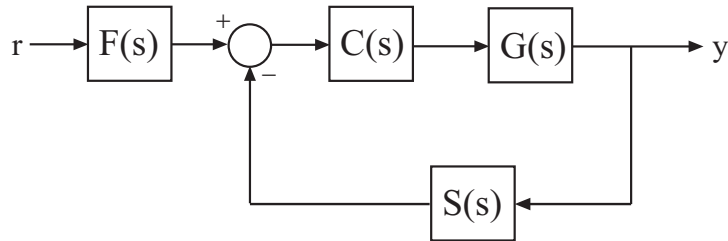

The plant response $G(s) = 1/(s + 1)^2$. The model of sensor dynamics is $S(s) = 5/(s + 4)$. The controller C is a tunable PID controller, and the prefilter $F = a/(s + a)$ is a low-pass filter with one tunable parameter, a .

Create models representing the plant and sensor dynamics.

Because the plant and sensor dynamics are fixed, represent them using numeric LTI models `zpk` and `tf`.

```
G = zpk([], [-1, -1], 1);
S = tf(5, [1 4]);
```

Create a tunable representation of the controller C .

```
C = ltiblock.pid('C', 'PID');
```

`C` is a `ltiblock.pid` object, which is a Control Design Block with a predefined proportional-integral-derivative (PID) structure. For more information about predefined Control Design Blocks, see “Control Design Blocks” on page 1-14.

Create a model of the filter $F = a/(s + a)$ with one tunable parameter.

```
a = realp('a', 10);
F = tf(a, [1 a]);
```

`a` is a `realp` (real tunable parameter) object with initial value 10. Using `a` as a coefficient in `tf` creates the tunable `genss` model object `F`.

Connect the models together to construct a model of the closed-loop response from r to y .

```
T = feedback(G*C, S)*F
```

T is a `genss` model object. In contrast to an aggregate model formed by connecting only Numeric LTI models, T keeps track of the tunable elements of the control system. The tunable elements are stored in the `Blocks` property of the `genss` model object. You can display the tunable elements of T by entering:

```
T.Blocks
```

```
ans =  
  
    C: [1x1 ltiblock.pid]  
    a: [1x1 realp]
```

If you have Robust Control Toolbox software, you can use tuning commands such as `systeme` to tune the free parameters of T to meet design requirements you specify. See “Automated Tuning” in the Robust Control Toolbox documentation.

More About

- “Models with Tunable Coefficients” on page 1-27

Model Arrays

In this section...

“Model Arrays” on page 2-59

“One-Dimensional Model Array with Single Parameter Variation” on page 2-62

“Select Models from Array” on page 2-63

“Array With Variations in Two Parameters” on page 2-66

“Sample a Tunable (Parametric) Model for Parameter Studies” on page 2-68

Model Arrays

What Are Model Arrays?

In many applications, it is useful to consider collections multiple model objects. For example, you may want to consider a model with a parameter that varies across a range of values, such as

```
sys1 = tf(1, [1 1 1]);  
sys2 = tf(1, [1 1 2]);  
sys3 = tf(1, [1 1 3]);
```

and so on. Model arrays are a convenient way to store and analyze such a collection. Model arrays are collections of multiple linear models, stored as elements in a single MATLAB array.

For all models collected in a single model array, the following attributes must be the same:

- The number of inputs and outputs
- The sample time `Ts`
- The time unit `TimeUnit`

Uses of Model Arrays

Uses of model arrays include:

- Representing and analyzing sensitivity to parameter variations
- Validating a controller design against several plant models
- Representing linear models arising from the linearization of a nonlinear system at several operating points
- Storing models obtained from several system identification experiments applied to one plant

Using model arrays, you can apply almost all of the basic model operations that work on single model objects to entire sets of models at once. Functions operate on arrays model by model, allowing you to manipulate an entire collection of models in a vectorized fashion. You can also use analysis functions such as `bode`, `nyquist`, and `step` to model arrays to analyze multiple models simultaneously. You can access the individual models in the collection through MATLAB array indexing.

Visualizing Model Arrays

To visualize the concept of a model array, consider the set of five transfer function models shown below. In this example, each model has two inputs and two outputs. They differ by parameter variations in the individual model components.

$$\begin{array}{ccccc}
 \left[\begin{array}{cc} \frac{1.1}{s+1} & 0 \\ 0 & \frac{1}{s+5} \end{array} \right] &
 \left[\begin{array}{cc} \frac{1.3}{s+1.1} & 0 \\ 0 & \frac{1}{s+5.2} \end{array} \right] &
 \left[\begin{array}{cc} \frac{1.11}{s+1.2} & 0 \\ 0 & \frac{1}{s+5.4} \end{array} \right] &
 \left[\begin{array}{cc} \frac{1.15}{s+1.3} & 0 \\ 0 & \frac{1}{s+5.6} \end{array} \right] &
 \left[\begin{array}{cc} \frac{1.09}{s+1.4} & 0 \\ 0 & \frac{1}{s+5.8} \end{array} \right]
 \end{array}$$

Just as you might collect a set of two-by-two matrices in a multidimensional array, you can collect this set of five transfer function models as a list in a model array under one variable name, say, `sys`. Each element of the model array is a single model object.

Visualizing Selection of Models From Model Arrays

The following illustration shows how indexing selects models from a one-dimensional model array. The illustration shows a 1-by-5 array `sysa` of 2-input, 2-output transfer functions.

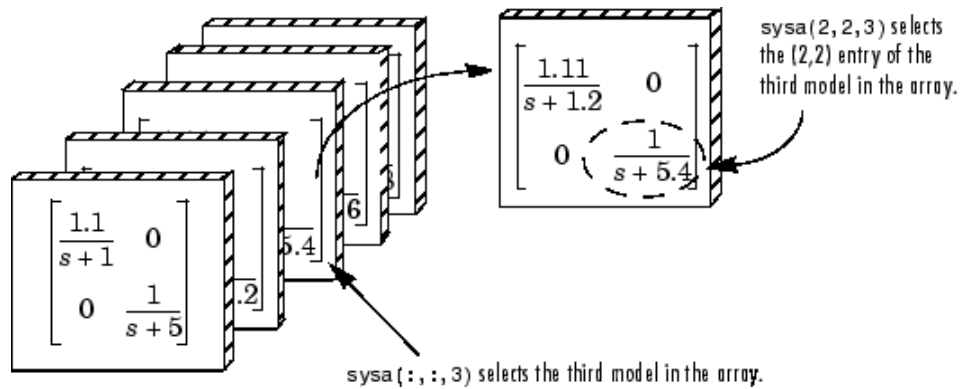

The following illustration shows selection of models from the two-dimensional model array `m2d`.

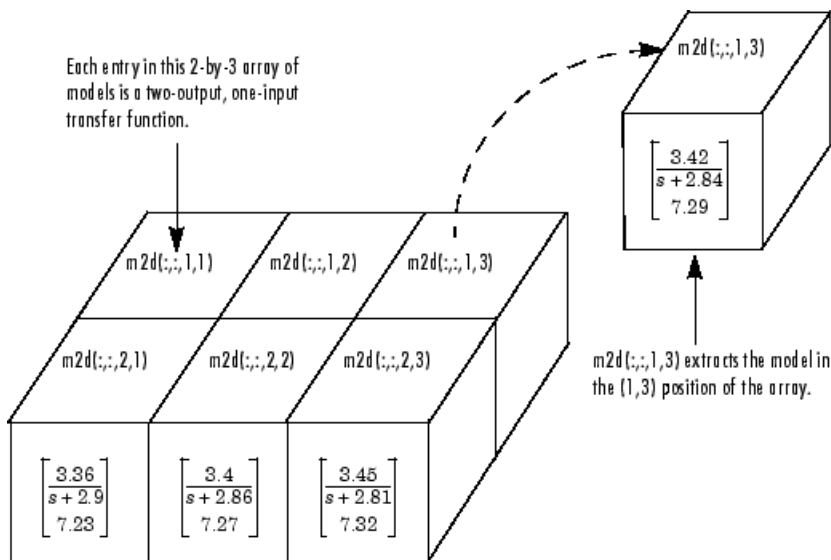

One-Dimensional Model Array with Single Parameter Variation

This example shows how to create a one-dimensional array of transfer functions using `stack`. One parameter of the transfer function varies from model to model in the array.

You can use such an array to investigate the effect of parameter variation on your model, such as for sensitivity analysis.

Create an array of transfer functions representing a low-pass filter

$$F(s) = \frac{a}{s+a}, \text{ at three values of the roll-off frequency } a:$$

- 1 Create transfer function models representing the filter with roll-off frequency at $a = 3, 5, \text{ and } 7$.

```
F1 = tf(3,[1 3]);  
F2 = tf(5,[1 5]);  
F3 = tf(7,[1 7]);
```

- 2 Use `stack` to build an array.

```
Farray = stack(1,F1,F2,F3);
```

The first argument to `stack` specifies the array dimension along which `stack` builds an array. The remaining arguments specify the models to arrange along that dimension.

`Farray` is a 3-by-1 array of transfer functions.

Note Concatenating models with MATLAB array concatenation commands, instead of with `stack`, creates multi-input, multi-output (MIMO) models rather than model arrays. For example:

```
G = [F1;F2;F3]
```

creates a one-input, three-output transfer function model, not a 3-by-1 array.

- 3 Plot the frequency response of the array to examine the effect of parameter variation on the filter behavior.

```
bodeplot(Farray)
```

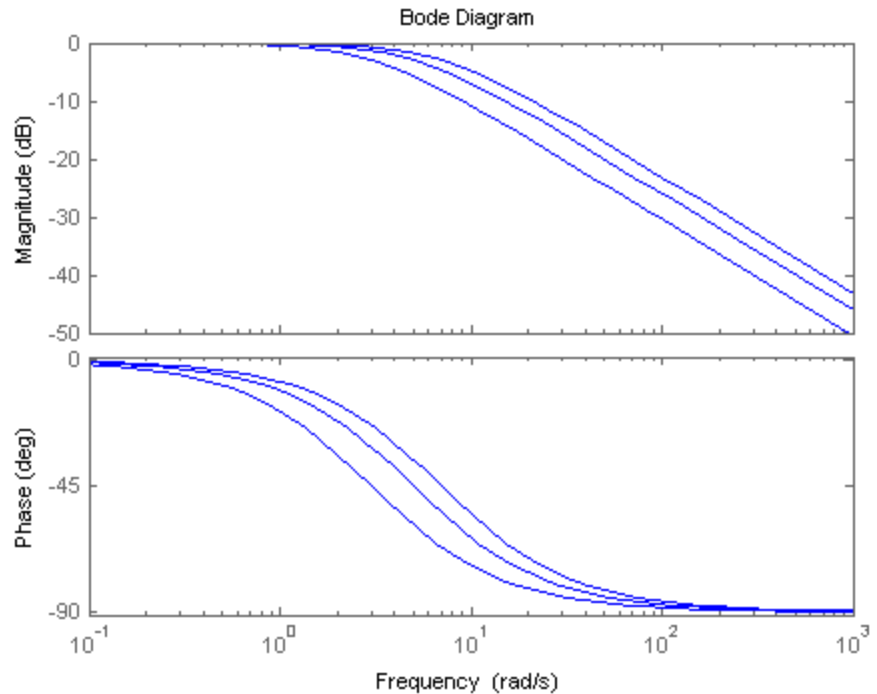

When you use analysis commands such as `bodeplot` on a model array, the resulting plot shows the response of each model in the array. Therefore, you can see the range of responses that results from the parameter variation.

Select Models from Array

This example shows how to select individual models or sets of models from a model array using array indexing.

- 1 Load the transfer function array `m2d` into the MATLAB workspace.

```
load LTIexamples m2d
```

2 (Optional) Plot the step response of m2d.

```
step(m2d)
```

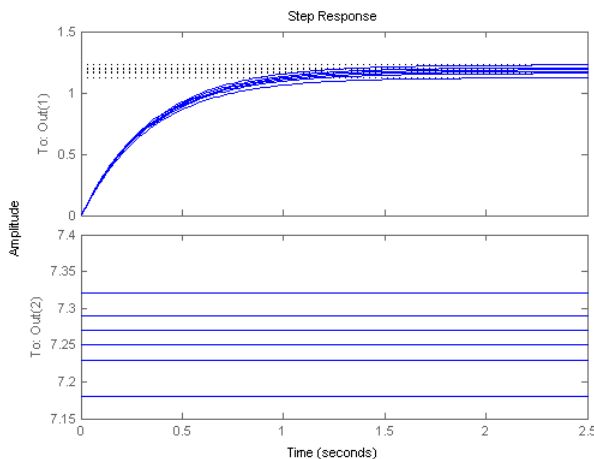

The step response shows that m2d contains six one-input, two-output models. The `step` command plots all of the models in an array on a single plot.

3 (Optional) Examine the dimensions of m2d.

```
arraydim = size(m2d)
```

This command produces the result:

```
arraydim =
```

```
      2      1      2      3
```

- The first entries of `arraydim`, 2 and 1, show that m2d is an array of two-output, one-input transfer functions.
- The remaining entries in `arraydim` give the array dimensions of m2d, 2-by-3.

In general, the dimensions of a model array are $[N_y, N_u, S_1, \dots, S_k]$. N_y and N_u are the numbers of outputs and inputs of each model in the array. S_1, \dots, S_k are the array dimensions. Thus, S_i is the number of models along the i th array dimension.

- 4** Select the transfer function in the second row, first column of `m2d`.

To do so, use MATLAB array indexing.

```
sys = m2d(:, :, 2, 1)
```

Tip You can also access models using single index referencing of the array dimensions. For example,

```
sys = m2d(:, :, 4)
```

selects the same model as `m2d(:, :, 2, 1)`.

- 5** Select the array of subsystems from the first input to the first output of each model in `m2d`.

```
m11 = m2d(1, 1, :, :)
```

- 6** (Optional) Plot the step response of `m11`.

```
step(m11)
```

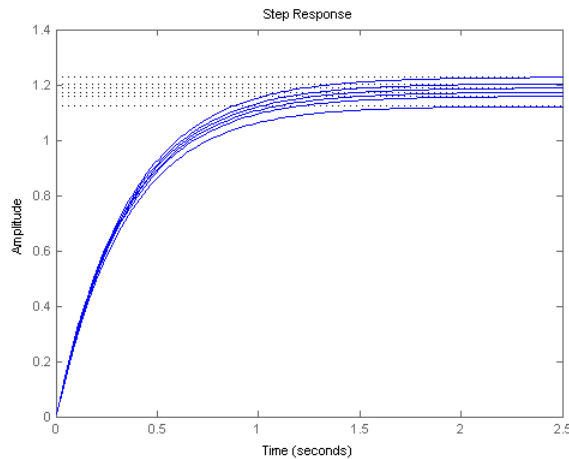

The step response shows that `m11` is an array of six single-input, single-output (SISO) models.

Note For frequency response data (FRD) models, the array indices can be followed by the keyword 'frequency' and some expression selecting a subset of the frequency points, as in:

```
sys(outputs,inputs,n1,...,nk,'frequency',SelectedFreqs)
```

More About

- “Visualizing Selection of Models From Model Arrays” on page 2-61

Array With Variations in Two Parameters

This example shows how to create a two-dimensional (2-D) array of transfer functions using for loops. One parameter of the transfer function varies in each dimension of the array.

You can use the technique of this example to create higher-dimensional arrays with variations of more parameters. Such arrays are useful for studying the effects of multiple-parameter variations on system response.

The second-order single-input, single-output (SISO) transfer function

$$H(s) = \frac{\omega^2}{s^2 + 2\zeta\omega s + \omega^2}.$$

depends on two parameters—the damping ratio ζ and natural frequency ω .

If both ζ and ω vary, you obtain multiple transfer functions of the form:

$$H_{ij}(s) = \frac{\omega_j^2}{s^2 + 2\zeta_i\omega_j s + \omega_j^2},$$

where ζ_i and ω_j represent different measurements or sampled values of the variable parameters.

You can collect all of these transfer functions in a single variable to create a two-dimensional model array.

1 (Optional) Preallocate memory for the model array.

You can enhance computation efficiency by preallocating memory. To do this, create an array of the required size and initialize its entries to zero.

```
H = tf(zeros(1,1,3,3));
```

In this example, there are three values for each parameter in the transfer function H . Therefore, this command creates a 3-by-3 array of single-input, single-output (SISO) zero transfer functions.

2 Create arrays containing the parameter values.

```
zeta = [0.66,0.71,0.75];
w = [1.0,1.2,1.5];
```

3 Build the array by looping through all combinations of parameter values.

```
for i = 1:length(zeta)
    for j = 1:length(w)
        H(:,:,i,j) = tf(w(j)^2,[1 2*zeta(i)*w(j) w(j)^2]);
    end
end
```

H is a 3-by-3 array of transfer functions. ζ varies as you move from model to model along a single column of H. The parameter ω varies as you move along a single row. Plotting the step response of H shows how the parameter variation affects the step response.

```
step(H)
```

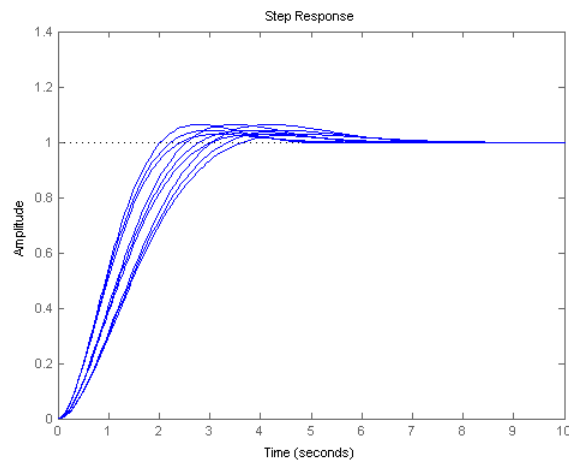

Sample a Tunable (Parametric) Model for Parameter Studies

This example shows how to sample a parametric model of a second-order filter across a grid of parameter values using `replaceBlock`.

- 1 Create a tunable (parametric) model of the second-order filter:

$$F(s) = \frac{\omega_n^2}{s^2 + 2\zeta\omega_n s + \omega_n^2},$$

where the damping ζ and the natural frequency ω_n are the parameters.

```
wn = realp('wn',3);  
zeta = realp('zeta',0.8);  
F = tf(wn^2,[1 2*zeta*wn wn^2]);
```

F is a genss model with two tunable Control Design Blocks, the realp blocks wn and zeta. The blocks wn and zeta have initial values of 3 and 0.8, respectively.

2 Sample F over a 2-by-3 grid of (wn,zeta) values.

```
Fsample = replaceBlock(F,'wn',[3;5],'zeta',[0.6 0.8 1.0]);
```

Fsample is 2-by-3 array of state-space models.

3 (Optional) Plot the step response of Fsample.

```
step(Fsample)
```

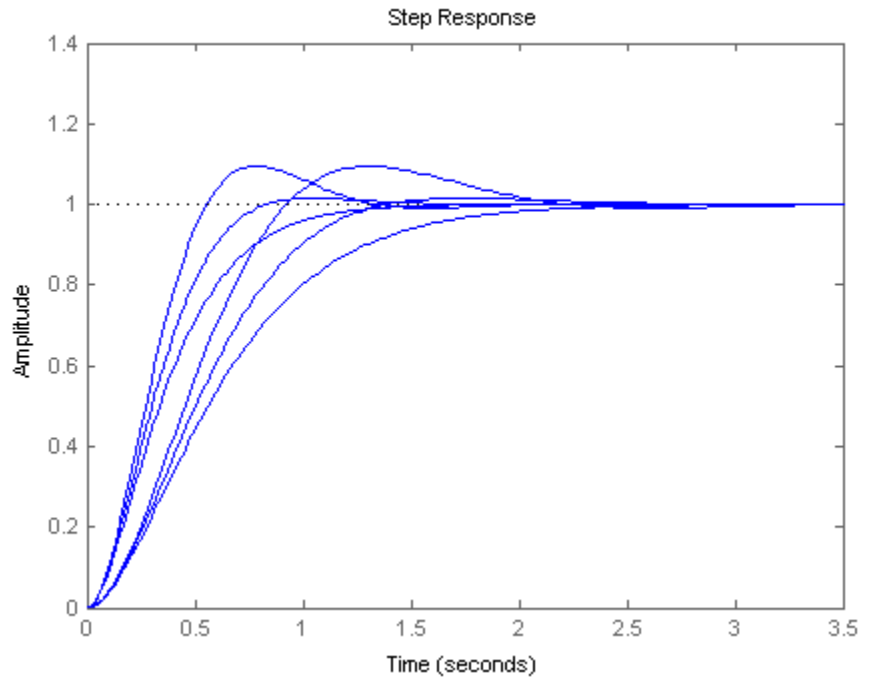

The step response plot show the variation in the natural frequency and damping constant across the six models in the array `Fsample`.

More About

- “Models with Tunable Coefficients” on page 1-27

Working with Linear Models

- Chapter 3, “Data Manipulation”
- Chapter 4, “Model Interconnections”
- Chapter 5, “Model Transformation”

Data Manipulation

- “Model Properties” on page 3-2
- “Extract Model Coefficients” on page 3-5
- “Attach Metadata to Models” on page 3-9
- “Query Model Characteristics” on page 3-14
- “Customize Model Display” on page 3-17

Model Properties

In this section...
“Model Properties” on page 3-2
“Specify Model Properties at Model Creation” on page 3-2
“Examine and Specify Properties of an Existing Model” on page 3-3

Model Properties

Model properties are data fields that let you specify model attributes, such as coefficients, sampling time, and metadata such as channel names.

For help on the properties associated with each model type, see the corresponding reference page. Alternatively, enter `help modeltype.propertyname` at the command line. For example:

```
help ss.StateName
```

Related Examples

- “Examine and Specify Properties of an Existing Model” on page 3-3
- “Specify Model Properties at Model Creation” on page 3-2

Specify Model Properties at Model Creation

This example shows how to specify transfer function model properties when you create the model. You can use the technique of this example to access and set properties of any type of model.

To specify model properties at model creation, use `Name, Value` pair syntax. For example, assign a transport delay and an output name to a new transfer function model:

```
H = tf(1,[1 10], 'ioDelay',6.5, 'OutputName', 'velocity')
```

Examine and Specify Properties of an Existing Model

This example shows how to examine and specify properties of an existing ss model using `get`, `set`, and dot notation. You can use the techniques of this example to examine and specify properties of any type of model.

- 1 Load an existing model object.

```
load PadeApproximation1 sys;
```

`sys` is a state-space (ss) model.

- 2 Examine the current property values.

```
get(sys)
```

This command displays all the properties of `sys`.

```
          a: [2x2 double]
          b: [2x1 double]
          c: [0.5000 0.1000]
          d: 0
          e: []
    Scaled: 0
    StateName: {2x1 cell}
    StateUnit: {2x1 cell}
InternalDelay: 3.4000
    InputDelay: 0
    OutputDelay: 1.5000
           Ts: 0
    TimeUnit: 'seconds'
    InputName: {' '}
    InputUnit: {' '}
    InputGroup: [1x1 struct]
    OutputName: {' '}
    OutputUnit: {' '}
    OutputGroup: [1x1 struct]
           Name: ''
           Notes: {}
    UserData: []
```

- 3 Specify input delay and channel names.

You can use dot notation to directly reference property values.

```
sys.InputDelay = 4.2;  
sys.InputName = 'thrust';  
sys.OutputName = 'velocity';
```

Alternatively, you can use the `set` command to specify property values.

```
set(sys, 'InputDelay', 4.2, 'InputName', 'thrust', ...  
      'OutputName', 'velocity');
```

Caution Changing certain properties, such as `Ts` and `TimeUnits`, can cause undesirable changes in system behavior. See the property descriptions in the model reference pages for more information.

Extract Model Coefficients

In this section...

“Functions for Extracting Model Coefficients” on page 3-5

“Extracting Coefficients of Different Model Type” on page 3-5

“Extract Numeric Model Data and Time Delay” on page 3-6

“Extract PID Gains from Transfer Function” on page 3-7

Functions for Extracting Model Coefficients

Control System Toolbox software includes several commands for extracting model coefficients such as transfer function numerator and denominator coefficients, state-space matrices, and proportional-integral-derivative (PID) gains.

The following commands are available for data extraction.

Command	Result
tfdata	Extract transfer function coefficients
zpkdata	Extract zero and pole locations and system gain
ssdata	Extract state-space matrices
dssdata	Extract descriptor state-space matrices
frdata	Extract frequency response data from frd model
piddata	Extract parallel-form PID data
pidstddata	Extract standard-form PID data
get	Access all model property values

Extracting Coefficients of Different Model Type

When you use a data extraction command on a model of a different type, the software computes the coefficients of the target model type. For example, if

you use `zpkdata` on a `ss` model, the software converts the model to `zpk` form and returns the zero and pole locations and system gain.

Extract Numeric Model Data and Time Delay

This example shows how to extract transfer function numerator and denominator coefficients using `tfdata`.

- 1 Create a first-order plus dead time transfer function model.

```
H = exp(-2.5*s)/(s+12);
```

- 2 Extract the numerator and denominator coefficients.

```
[num,den] = tfdata(H,'v')
```

The variables `num` and `den` are numerical arrays. Without the `'v'` flag, `tfdata` returns cell arrays.

Note For SISO transfer function models, you can also extract coefficients using:

```
num = H.num{1};  
den = H.den{1};
```

- 3 Extract the time delay.

- a Determine which property of `H` contains the time delay.

In a SISO `tf` model, you can express a time delay as an input delay, an output delay, or a transport delay (I/O delay).

```
get(H)
```

This command returns:

```
num: {[0 1]}  
den: {[1 12]}  
Variable: 's'
```



```

        ioDelay: 0
        InputDelay: 0
        OutputDelay: 2.5000
        Ts: 0
        TimeUnit: 'seconds'
        InputName: {''}
        InputUnit: {''}
        InputGroup: [1x1 struct]
        OutputName: {''}
        OutputUnit: {''}
        OutputGroup: [1x1 struct]
        Name: ''
        Notes: {}
        UserData: []

```

The time delay is stored in the `OutputDelay` property.

- b** Extract the output delay.

```
delay = H.OutputDelay;
```

Extract PID Gains from Transfer Function

This example shows how to extract PID (proportional-integral-derivative) gains from a transfer function using `piddata`. You can use the same steps to extract PID gains from a model of any type that represents a PID controller, using `piddata` or `pidstdata`.

- 1** Create a transfer function that represents a PID controller with a first-order filter on the derivative term.

```
Czpk = zpk([-6.6, -0.7], [0, -2], 0.2)
```

- 2** Obtain the PID gains and filter constant.

```
[Kp, Ki, Kd, Tf] = piddata(Czpk)
```

This command returns the proportional gain `Kp`, integral gain `Ki`, derivative gain `Kd`, and derivative filter time constant `Tf`. Because `piddata` automatically computes the PID controller parameters, you can extract the PID coefficients without creating a `pid` model.

More About

- “PID Controllers” on page 1-23

Attach Metadata to Models

In this section...

- “Specify Model Time Units” on page 3-9
- “Interconnect Models with Different Time Units” on page 3-10
- “Specify Frequency Units of Frequency-Response Data Model” on page 3-10
- “Extract Subsystems of Multi-Input, Multi-Output (MIMO) Models” on page 3-11
- “Specify and Select Input and Output Groups” on page 3-12

Specify Model Time Units

This example shows how to specify time units of a transfer function model.

The `TimeUnit` property of the `tf` model object specifies units of the time variable, time delays (for continuous-time models), and the sampling time `Ts` (for discrete-time models). The default time units is seconds.

Create a SISO transfer function model $sys = \frac{4s + 2}{s^2 + 3s + 10}$ with time units in milliseconds:

```
num = [4 2];
den = [1 3 10];
sys = tf(num,den,'TimeUnit','milliseconds');
```

You can specify the time units of any dynamic system in a similar way.

The system time units appear on the time- and frequency-domain plots. For multiple systems with different time units, the units of the first system are used if the time and frequency units in the “Toolbox Preferences Editor” on page 12-2 are auto.

Note Changing the `TimeUnit` property changes the system behavior. If you want to use different time units without modifying system behavior, use `chgTimeUnit`.

Interconnect Models with Different Time Units

This example shows how to interconnect transfer function models with different time units.

To interconnect models using arithmetic operations or interconnection commands, the time units of all models must match.

- 1 Create two transfer function models with time units of milliseconds and seconds, respectively.

```
sys1 = tf([1 2],[1 2 3],'TimeUnit','milliseconds');  
sys2 = tf([4 2],[1 3 10]);
```

- 2 Change the time units of `sys2` to milliseconds.

```
sys2 = chgTimeUnit(sys2,'milliseconds');
```

- 3 Connect the systems in parallel.

```
sys = sys1+sys2;
```

Specify Frequency Units of Frequency-Response Data Model

This example shows how to specify units of the frequency points of a frequency-response data model.

The `FrequencyUnit` property specifies units of the frequency vector in the `Frequency` property of the `frd` model object. The default frequency units are `rad/TimeUnit`, where `TimeUnit` is the time unit specified in the `TimeUnit` property.

Create a SISO frequency-response data model with frequency data in GHz.

```
load AnalyzerData;
```

```
sys = frd(resp,freq,'FrequencyUnit','GHz');
```

You can independently specify the units in which you measure the frequency points and sample time in the `FrequencyUnit` and `TimeUnit` properties, respectively. You can also specify the frequency units of a `genfrd` in a similar way.

The frequency units appear on the frequency-domain plots. For multiple systems with different frequency units, the units of the first system are used if the frequency units in the “Toolbox Preferences Editor” on page 12-2 is `auto`.

Note Changing the `FrequencyUnit` property changes the system behavior. If you want to use different frequency units without modifying system behavior, use `chgFreqUnit`.

Extract Subsystems of Multi-Input, Multi-Output (MIMO) Models

This example shows how to extract subsystems of a MIMO model using MATLAB indexing and using channel names.

Extracting subsystems is useful when, for example, you want to analyze a portion of a complex system.

Create a MIMO transfer function.

```
G1 = tf(3,[1 10]);  
G2 = tf([1 2],[1 0]);  
G = [G1,G2];
```

Extract the subsystem of `G` from the first input to all outputs.

```
Gsub = G(:,1);
```

This command uses MATLAB indexing to specify a subsystem as `G(out,in)`, where `out` specifies the output indices and `in` specifies the input indices.

Using channel names, you can use MATLAB indexing to extract all the dynamics relating to a particular channel. By using this approach, you can avoid having to keep track of channel order in a complex MIMO model.

Assign names to the model inputs.

```
G.InputName = {'temperature'; 'pressure'};
```

Because `G` has two inputs, use a cell array of two strings to specify the channel names.

Extract the subsystem of `G` that contains all dynamics from the 'temperature' input to all outputs.

```
Gt = G(:, 'temperature');
```

`Gt` is the same subsystem as `Gsub`.

Note When you extract a subsystem from a state-space (ss) model, the resulting state-space model may not be minimal. Use `sminreal` to eliminate unnecessary states in the subsystem.

Specify and Select Input and Output Groups

This example shows how to specify groups of input and output channels in a model object and extract subsystems using the groups.

Input and output groups are useful for keeping track of inputs and outputs in complex MIMO models.

1 Create a state-space model with three inputs and four outputs.

```
H = rss(3,4,3);
```

2 Group the inputs as follows:

- Inputs 1 and 2 in a group named `controls`
- Outputs 1 and 3 to a group named `temperature`
- Outputs 1, 3, and 4 to a group named `measurements`

```
H.InputGroup.controls = [1 2];  
H.OutputGroup.temperature = [1 3];  
H.OutputGroup.measurements = [1 3 4];
```

`InputGroup` and `OutputGroup` are structures. The name of each field in the structure is the name of the input or output group. The value of each field is a vector that identifies the channels in that group.

- 3 Extract the subsystem corresponding to the `controls` inputs and the `temperature` outputs.

You can use group names to index into subsystems.

```
Hc = H('temperature','controls')
```

`Hc` is a two-input, two-output `ss` model containing the I/O channels from the `'controls'` input to the `'temperature'` outputs.

You can see the relationship between `H` and the subsystem `Hc` in this illustration.

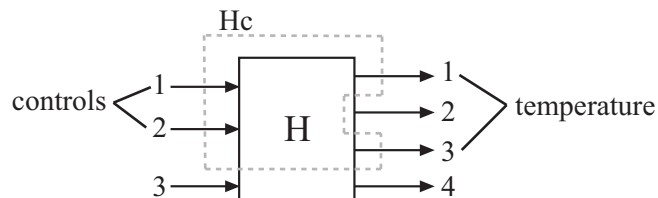

Query Model Characteristics

In this section...
“Query Model Dynamics” on page 3-14
“Query Array Size” on page 3-15

How to query model characteristics such as stability, time domain, and number of inputs and outputs.

Query Model Dynamics

This example shows how to query model dynamics such as stability, time domain, and model order. You can use the techniques of this example on type of model.

- 1 Load a saved state-space model.

```
load queryexample.mat T;
```

- 2 Query whether T has stable dynamics.

```
isstable(T)
```

The `isstable` command returns a Boolean value of 1 (true) if all system poles are in the open left-half plane (for continuous-time models) or inside the open unit disk (for discrete-time models). Otherwise, `isstable` returns 0 (false).

- 3 Query whether T has any time delays.

```
hasdelay(T)
```

This command returns 1, which indicates that T has a time delay. For a state-space model, time delay can be stored as input delay, output delay, or internal delay. Use `get(T)` to determine which properties of T hold the time delay.

- 4 Query whether T is proper.

```
isproper(T)
```

This command returns 1, if the system has relative degree ≤ 0 .

5 Query the order of T.

```
order(T)
```

For a state-space model, `order` returns the number of states. For a `tf` or `zpk` model, the order is the number of states required for a state-space realization of the system.

6 Query whether T is a discrete-time model.

```
isdt(T)
```

This command returns 1, indicating that T is a discrete-time model. Similarly, you can use `isct` to query whether T is a continuous-time model.

Query Array Size

This example shows how to query the size of model arrays, including the number of inputs and outputs and the number of models in an array.

You can also use these commands on individual models.

1 Load a saved model array.

```
load queryexample sysarr
```

2 Query the array dimensions.

```
size(sysarr)
```

This command displays the array size, and the number of inputs, outputs, and states of the models in the array.

Alternatively, to obtain the array dimensions as a numeric array, use `size` with an output argument.

```
dims = size(sysarr)
```

This command produces the result:

```
dims =
```

```
3    1    2    4
```

The first two entries 3, 1 are the number of outputs and inputs, respectively. The remaining entries 2, 4 are the array dimensions.

Tip To query the number of array dimensions, use `ndims`.

3 Query the number of models in the array.

```
N = nmodels(sysarr)
```

Because `sysarr` is a 2-by-4 array, this command returns a result of $2 \times 4 = 8$.

4 Query whether the models in `sysarr` are single-input, single-output (SISO).

```
issiso(sysarr)
```

The command `issiso` returns a Boolean value of 1 (true) if the models in the array are SISO, and 0 (false) if the models are not SISO.

5 Query the number of inputs and outputs in the models in the array using `iosize`.

```
ios = iosize(sysarr)
```

This command returns a numeric array containing the number of outputs and inputs of the models in the array.

Related Examples

- “Select Models from Array” on page 2-63

Customize Model Display

How to customize the MATLAB screen display of transfer function models.

In this section...

“Configure Transfer Function Display Variable” on page 3-17

“Configure Display Format of Transfer Function in Factorized Form” on page 3-18

Configure Transfer Function Display Variable

This example shows how to configure the display variable of transfer function (tf) models.

You can use the same steps to configure the display variable of transfer function models in factorized form (zpk models).

By default, tf and zpk models are displayed in terms of s in continuous time and z in discrete time. Use the `Variable` property change the display variable to 'p' (equivalent to 's'), 'q' (equivalent to 'z'), 'z^-1', or 'q^-1'.

1 Create the discrete-time transfer function $H(z) = \frac{z-1}{z^2-3z+2}$

with a sampling time of 1 s.

```
H = tf([1 -1],[1 -3 2],0.1)
```

```
H =
```

```
      z - 1
-----
z^2 - 3 z + 2
```

```
Sample time: 0.1 seconds
Discrete-time transfer function.
```

The default display variable is z.

2 Change the display variable to q^{-1} .

```
H.Variable = 'q^-1'
```

```
H =
```

$$\frac{q^{-1} - q^{-2}}{1 - 3q^{-1} + 2q^{-2}}$$

```
Sample time: 0.1 seconds  
Discrete-time transfer function.
```

When you change the `Variable` property, the software computes new coefficients and displays the transfer function in terms of the new variable. The `num` and `den` properties are automatically updated with the new coefficients.

Tip Alternatively, you can directly create the same transfer function expressed in terms of q^{-1} .

```
H = tf([0 1 -1],[1 -3 2],0.1,'Variable','q^-1');
```

For the inverse variables z^{-1} and q^{-1} , `tf` interprets the numerator and denominator arrays as coefficients of ascending powers of z^{-1} or q^{-1} .

Configure Display Format of Transfer Function in Factorized Form

This example shows how to configure the display of transfer function models in factorized form (zpk models).

You can configure the display of the factorized numerator and denominator polynomials to highlight:

- The numerator and denominator roots
- The natural frequencies and damping ratios of each root
- The time constants and damping ratios of each root

See the `DisplayFormat` property on the `zpk` reference page for more information about these quantities.

- 1 Create a `zpk` model having a zero at $s = 5$, a pole at $s = -10$, and a pair of complex poles at $s = -3 \pm 5i$.

```
H = zpk(5, [-10, -3-5*i, -3+5*i], 10)
```

```
H =
```

$$\frac{10 (s-5)}{(s+10) (s^2 + 6s + 34)}$$

Continuous-time zero/pole/gain model.

The default display format, 'roots', displays the standard factorization of the numerator and denominator polynomials.

- 2 Configure the display format to display the natural frequency of each polynomial root.

```
H.DisplayFormat = 'frequency'
```

```
H =
```

$$\frac{-0.14706 (1-s/5)}{(1+s/10) (1 + 1.029(s/5.831) + (s/5.831)^2)}$$

Continuous-time zero/pole/gain model.

You can read the natural frequencies and damping ratios for each pole and zero from the display as follows:

- Factors corresponding to real roots are displayed as $(1 - s/\omega_0)$. The variable ω_0 is the natural frequency of the root. For example, the natural frequency of the zero of `H` is 5.
- Factors corresponding to complex pairs of roots are displayed as $1 - 2\zeta(s/\omega_0) + (s/\omega_0)^2$. The variable ω_0 is the natural frequency, and ζ is

the damping ratio of the root. For example, the natural frequency of the complex pole pair is 5.831, and the damping ratio is 1.029/2.

- 3** Configure the display format to display the time constant of each pole and zero.

```
H.DisplayFormat = 'time constant'
```

```
H =
```

```

              -0.14706 (1-0.2s)
-----
(1+0.1s) (1 + 1.029(0.1715s) + (0.1715s)^2)

```

```
Continuous-time zero/pole/gain model.
```

You can read the time constants and damping ratios from the display as follows:

- Factors corresponding to real roots are displayed as (τs) . The variable τ is the time constant of the root. For example, the time constant of the zero of H is 0.2.
- Factors corresponding to complex pairs of roots are displayed as $1 - 2\zeta(\tau s) + (\tau s)^2$. The variable τ is the time constant, and ζ is the damping ratio of the root. For example, the time constant of the complex pole pair is 0.1715, and the damping ratio is 1.029/2.

Model Interconnections

- “Why Interconnect Models?” on page 4-2
- “Catalog of Model Interconnections” on page 4-3
- “Arithmetic Operations” on page 4-5
- “Numeric Model of SISO Feedback Loop” on page 4-6
- “Tunable Model of SISO Feedback Loop” on page 4-8
- “Multi-Loop Control System” on page 4-10
- “MIMO Control System” on page 4-13
- “MIMO Feedback Loop” on page 4-16
- “How the Software Determines Properties of Connected Models” on page 4-20
- “Precedence Rules That Determine Model Type” on page 4-22
- “Recommended Model Type for Building Block Diagrams” on page 4-23

Why Interconnect Models?

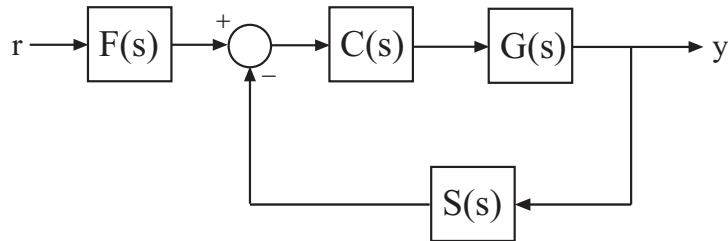

Interconnecting models of components allows you to construct models of control systems. You can conceptualize your control system as a block diagram containing multiple interconnected components, such as a plant or a controller. Using model arithmetic or interconnection commands, you combine models of each of these components into a single model representing the entire block diagram.

For example, you can interconnect dynamic system models of a plant $G(s)$, a controller $C(s)$, sensor dynamics $S(s)$, and a filter $F(s)$ to construct a single model that represents the entire closed-loop control system in the following illustration:

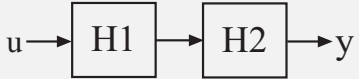
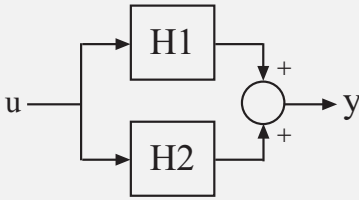
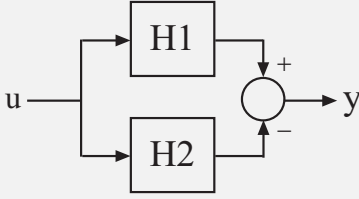
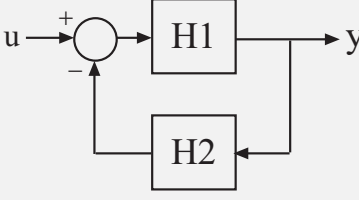

Catalog of Model Interconnections

Each type of block diagram connection correspond to a model interconnection command or arithmetic expression. The following table summarizes the block diagram connections with the corresponding interconnection command and arithmetic expression.

Block Diagram Connection	Command	Arithmetic Expression
	<code>series(H1,H2)</code>	$H2 * H1$
	<code>parallel(H1,H2)</code>	$H1 + H2$
	<code>parallel(H1,-H2)</code>	$H1 - H2$
	<code>feedback(H1,H2)</code>	$H1 / (1 + H2 * H1)$ (not recommended)
	N/A	$H1 / H2$ (division)

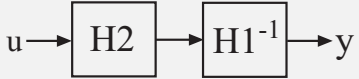
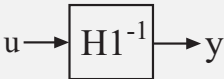
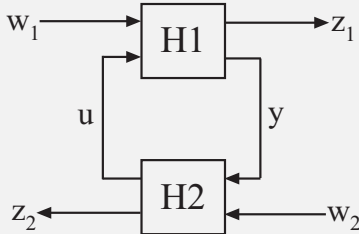
Block Diagram Connection	Command	Arithmetic Expression
	N/A	H1 \ H2 (left division)
	inv(H1)	N/A
	lft(H1,H2,nu,ny)	N/A

Use connect to build arbitrary block diagram interconnections.

Related Examples

- “Numeric Model of SISO Feedback Loop” on page 4-6
- “Tunable Model of SISO Feedback Loop” on page 4-8
- “Multi-Loop Control System” on page 4-10
- “MIMO Control System” on page 4-13
- “MIMO Feedback Loop” on page 4-16

Arithmetic Operations

You can apply almost all arithmetic operations to dynamic system models, including those shown below.

Operation	Description
+	Addition
-	Subtraction
*	Multiplication
.*	Element-by-element multiplication
/	Right matrix divide
\	Left matrix divide
inv	Matrix inversion
'	Pertransposition
.'	Transposition
^	Powers of a dynamic system model (as in s^2)

Numeric Model of SISO Feedback Loop

This example shows how to interconnect “Numeric LTI Models” on page 1-18 representing multiple system components to build a single numeric model of a closed-loop system, using model arithmetic and interconnection commands.

Construct a model of the following single-loop control system.

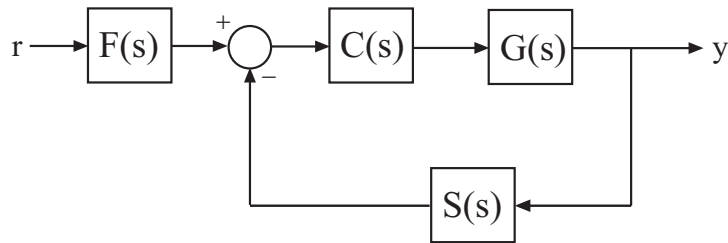

The feedback loop includes a plant $G(s)$, a controller $C(s)$, and a representation of sensor dynamics, $S(s)$. The system also includes a prefilter $F(s)$.

1 Create model objects representing each of the components.

```
G = zpk([], [-1, -1], 1);
C = pid(2, 1.3, 0.3, 0.5);
S = tf(5, [1 4]);
F = tf(1, [1 1]);
```

The plant G is a zero-pole-gain (zpk) model with a double pole at $s = -1$. Model object C is a PID controller. The models F and S are transfer functions.

2 Connect the controller and plant models.

```
H = G*C;
```

To combine models using the multiplication operator $*$, enter the models in reverse order compared to the block diagram.

Tip Alternatively, construct $H(s)$ using the `series` command:

```
H = series(C,G);
```

3 Construct the unfiltered closed-loop response $T(s) = \frac{H}{1+HS}$.

```
T = feedback(H,S);
```

Caution Do not use model arithmetic to construct T algebraically:

```
T = H/(1+H*S)
```

This computation duplicates the poles of H , which inflates the model order and might lead to computational inaccuracy.

4 Construct the entire closed-loop system response from r to y .

```
T_ry = T*F;
```

T_{ry} is a Numeric LTI Model representing the aggregate closed-loop system. T_{ry} does not keep track of the coefficients of the components G , C , F , and S .

You can operate on T_{ry} with any Control System Toolbox control design or analysis commands.

Tunable Model of SISO Feedback Loop

This example shows how to create a tunable model of the control system in the following illustration.

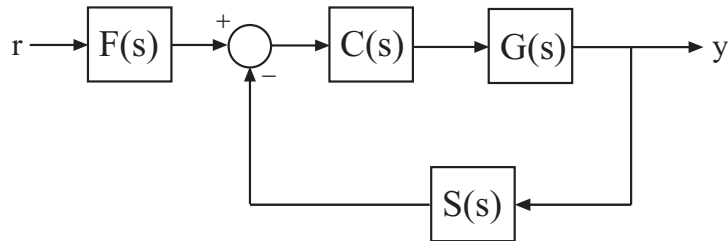

The plant response $G(s) = 1/(s + 1)^2$. The model of sensor dynamics is $S(s) = 5/(s + 4)$. The controller C is a tunable PID controller, and the prefilter $F = a/(s + a)$ is a low-pass filter with one tunable parameter, a .

Create models representing the plant and sensor dynamics.

Because the plant and sensor dynamics are fixed, represent them using numeric LTI models `zpk` and `tf`.

```
G = zpk([], [-1, -1], 1);
S = tf(5, [1 4]);
```

Create a tunable representation of the controller C .

```
C = ltiblock.pid('C', 'PID');
```

`C` is a `ltiblock.pid` object, which is a Control Design Block with a predefined proportional-integral-derivative (PID) structure. For more information about predefined Control Design Blocks, see “Control Design Blocks” on page 1-14.

Create a model of the filter $F = a/(s + a)$ with one tunable parameter.

```
a = realp('a', 10);
F = tf(a, [1 a]);
```

`a` is a `realp` (real tunable parameter) object with initial value 10. Using `a` as a coefficient in `tf` creates the tunable `genss` model object `F`.

Connect the models together to construct a model of the closed-loop response from r to y .

```
T = feedback(G*C,S)*F
```

T is a `genss` model object. In contrast to an aggregate model formed by connecting only Numeric LTI models, T keeps track of the tunable elements of the control system. The tunable elements are stored in the `Blocks` property of the `genss` model object. You can display the tunable elements of T by entering:

```
T.Blocks
```

```
ans =
```

```
  C: [1x1 ltiblock.pid]  
  a: [1x1 realp]
```

If you have Robust Control Toolbox software, you can use tuning commands such as `sys tune` to tune the free parameters of T to meet design requirements you specify. See “Automated Tuning” in the Robust Control Toolbox documentation.

Multi-Loop Control System

This example shows how to build an arbitrary block diagram by connecting models using `connect`. The system is a Smith Predictor, the single-input, single-output (SISO) multi-loop control system shown in the following block diagram.

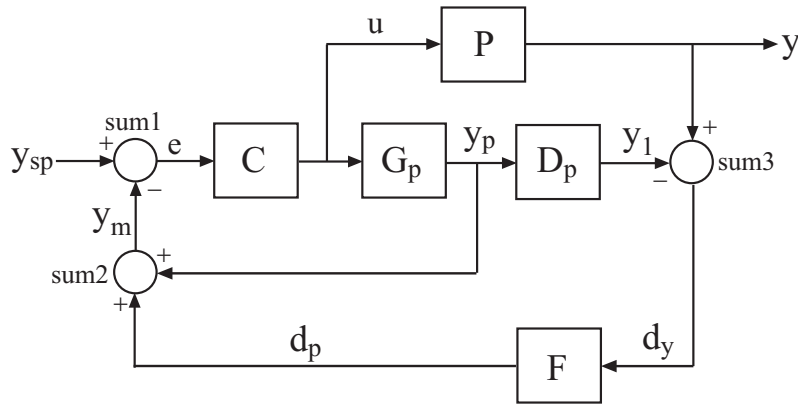

For more information about the Smith Predictor, see *Control of Processes with Long Dead Time: The Smith Predictor*.

The `connect` command lets you construct the overall transfer function from y_{sp} to y . To use `connect`, specify the input and output channel names of the components of the block diagram. `connect` automatically joins ports that have the same name, as shown in the following figure.

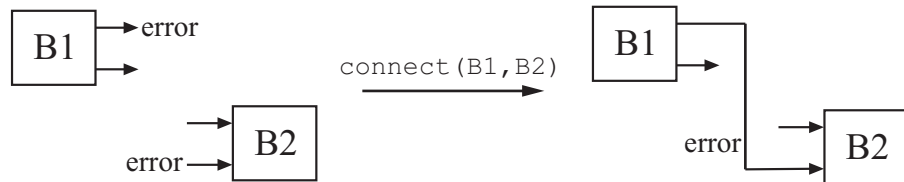

To build the closed loop model of the Smith Predictor system from y_{sp} to y :

- 1 Create the components of the block diagram: the process model P , the predictor model G_p , the delay model D_p , the filter F , and the PI controller

C. Specify names for the input and output channels of each model so that connect can automatically join them to build the block diagram.

```
s = tf('s');

P = exp(-93.9*s) * 5.6/(40.2*s+1);
P.InputName = 'u'; P.OutputName = 'y';

Gp = 5.6/(40.2*s+1);
Gp.InputName = 'u'; Gp.OutputName = 'yp';

Dp = exp(-93.9*s);
Dp.InputName = 'yp'; Dp.OutputName = 'y1';

F = 1/(20*s+1);
F.InputName = 'dy'; F.OutputName = 'dp';

C = pidstd(0.574,40.1);
C.Inputname = 'e'; C.OutputName = 'u';
```

2 Create the summing junctions needed to complete the block diagram.

```
sum1 = sumblk('e = ysp - ym');
sum2 = sumblk('ym = yp + dp');
sum3 = sumblk('dy = y - y1');
```

The argument to `sumblk` is a formula specified as a string. This string relates the input and output signals of the summing junction. `sumblk` creates a summing junction with the input and output signal names specified in the formula. For example, in `sum1`, the string `'e = ysp - ym'` specifies an output signal named `e`, which is the difference between input signals named `ysp` and `ym`.

3 Assemble the complete model from y_{sp} to y .

```
T = connect(P,Gp,Dp,C,F,sum1,sum2,sum3,'ysp','y');
```

You can list the models and summing junctions in any order because `connect` automatically interconnects them using their input and output channel names.

The last two arguments specify the input and output signals of the multi-loop control structure. Thus, T is a ss model with input y_{sp} and output y .

MIMO Control System

This example shows how to build a MIMO control system using connect to interconnect Numeric LTI models and tunable Control Design Blocks.

Consider the following two-input, two-output control system.

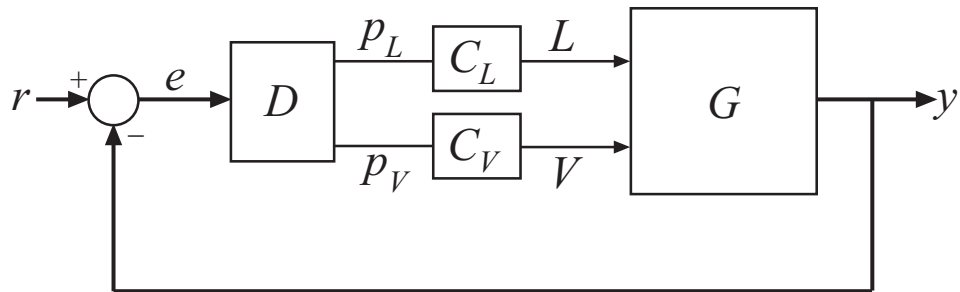

The plant G is a distillation column with two inputs and two outputs. The two inputs are the reflux L and boilup V . The two outputs are the concentrations of two chemicals, represented by the vector signal $y = [y_1, y_2]$. You can represent this plant model as:

$$G(s) = \frac{1}{75s + 1} \begin{bmatrix} 87.8 & -86.4 \\ 108.2 & -109.6 \end{bmatrix}.$$

The vector setpoint signal $r = [r_1, r_2]$ specifies the desired concentrations of the two chemicals. The vector error signal e represents the input to D , a static 2-by-2 decoupling matrix. C_L and C_V represent independent PI controllers that control the two inputs of G .

To create a two-input, two-output model representing this closed-loop control system:

- 1 Create a Numeric LTI model representing the 2-by-2 plant G .

```
s = tf('s', 'TimeUnit', 'minutes');
G = [87.8 -86.4 ; 108.2 -109.6]/(75*s+1);
G.InputName = {'L', 'V'};
G.OutputName = 'y';
```

When you construct the closed-loop model, `connect` uses the input and output names to form connections between the block diagram components. Therefore, you must assign names to the inputs and outputs of the transfer function `G` in either of the following ways: .

- You can assign input and output names to individual signals by specifying signal names in a cell array, as in `G.InputName = {'L', 'V'}`
- Alternatively, you can use vector signal naming, which the software automatically expands. For example, the command `G.OutputName = 'y'` assigns the names `'y(1)'` and `'y(2)'` to the outputs of `G`.

2 Create tunable Control Design Blocks representing the decoupling matrix D and the PI controllers C_L and C_V .

```
D = ltiblock.gain('Decoupler',eye(2));
D.u = 'e';
D.y = {'pL','pV'};

C_L = ltiblock.pid('C_L','pi'); C_L.TimeUnit = 'minutes';
C_L.u = 'pL'; C_L.y = 'L';

C_V = ltiblock.pid('C_V','pi'); C_V.TimeUnit = 'minutes';
C_V.u = 'pV'; C_V.y = 'V';
```

Note `u` and `y` are shorthand notations for the `InputName` and `OutputName` properties, respectfully. Thus, for example, entering:

```
D.u = 'e';
D.y = {'pL','pV'};
```

is equivalent to entering:

```
D.InputName = 'e';
D.OutputName = {'pL','pV'};
```

3 Create the summing junction.

The summing junction produces the error signals e by taking the difference between r and y .

```
Sum = sumblk('e = r - y',2);
```

Sum represents the transfer function for the summing junction described by the formula string 'e = r - y'. The second argument to `sumblk` specifies that the inputs and outputs of Sum are each vector signals of length 2. The software therefore automatically assigns the signal names {'r(1)', 'r(2)', 'y(1)', 'y(2)'} to Sum.InputName and {'e(1)', 'e(2)'} to Sum.OutputName.

- 4 Join all components to build the closed-loop system from r to y .

```
CLry = connect(G,D,C_L,C_V,Sum,'r','y');
```

The arguments to the `connect` function include all the components of the closed-loop system, in any order. `connect` automatically combines the components using the input and output names to join signals.

The last two arguments to `connect` specify the output and input signals of the closed-loop model, respectively. The resulting `genss` model CLry has two-inputs and two outputs.

MIMO Feedback Loop

This example shows three ways to obtain the closed-loop response from Azref to Az of the MIMO feedback loop of the following block diagram.

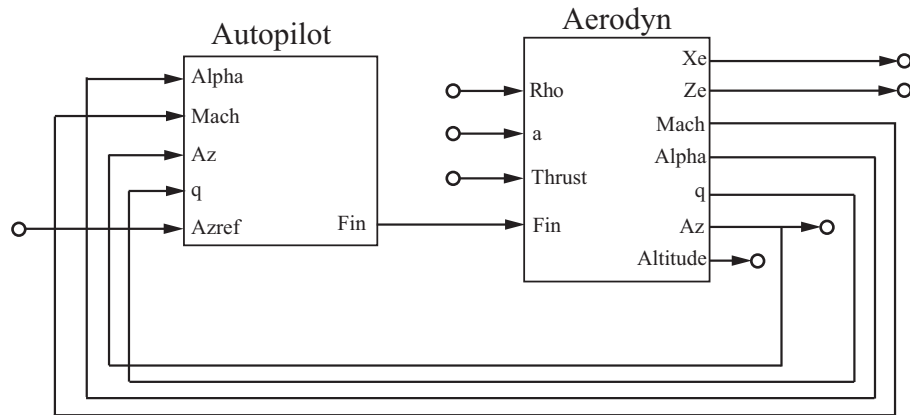

You can compute the closed-loop response using one of the following three approaches:

- Name-based interconnection with `connect`
- Name-based interconnection with `feedback`
- Index-based interconnection with `feedback`

You can use whichever of these approaches is most convenient for your application.

Load the plant Aerodyn and the controller Autopilot.

```
load MIMOfeedback.mat Aerodyn Autopilot
```

Aerodyn is a 4-input, 7-output state-space (ss) model. Autopilot is a 5-input, 1-output ss model. The inputs and outputs of both models names appear as shown in the block diagram.

Compute the closed-loop response from Azref to Az using `connect`.

```
T1 = connect(Autopilot,Aerodyn,'Azref','Az');
```

The `connect` function combines the models by joining the inputs and outputs that have matching names. The last two arguments to `connect` specify the input and output signals of the resulting model. Therefore, T1 is a state-space model with input Azref and output Az.

Compute the closed-loop response from Azref to Az using name-based interconnection with the `feedback` command. Use the model input and output names to specify the interconnections between Aerodyn and Autopilot.

When you use the `feedback` function, think of the closed-loop system as a feedback interconnection between an open-loop plant-controller combination L and a diagonal unity-gain feedback element K. The following block diagram shows this interconnection.

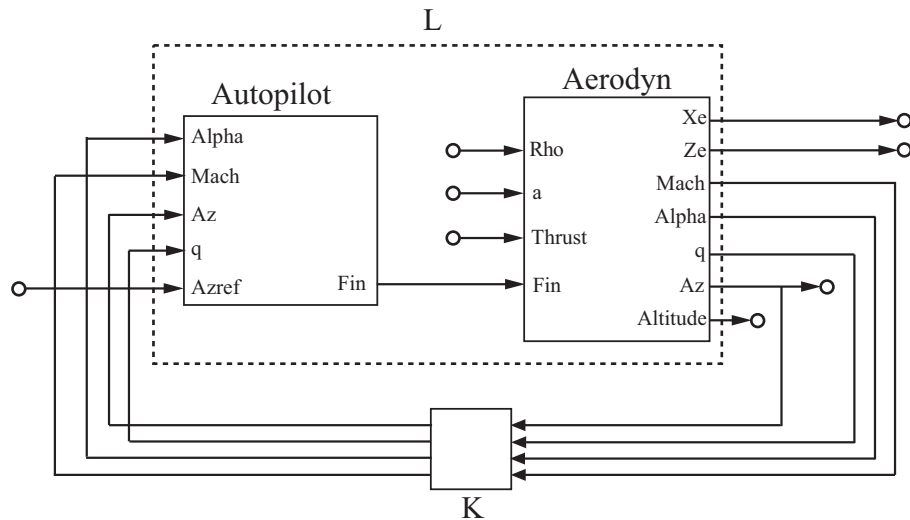

```
L = series(Autopilot,Aerodyn,'Fin');
```

```
FeedbackChannels = {'Alpha','Mach','Az','q'};
K = ss(eye(4),'InputName',FeedbackChannels,...
      'OutputName',FeedbackChannels);
```

```
T2 = feedback(L,K,'name',+1);
```

The closed-loop model T2 represents the positive feedback interconnection of L and K. The 'name' option causes `feedback` to connect L and K by matching their input and output names.

T2 is a 5-input, 7-output state-space model. The closed-loop response from Azref to Az is `T2('Az','Azref')`.

Compute the closed-loop response from Azref to Az using `feedback`, using indices to specify the interconnections between Aerodyn and Autopilot.

```
L = series(Autopilot,Aerodyn,1,4);  
K = ss(eye(4));
```

```
T3 = feedback(L,K,[1 2 3 4],[4 3 6 5],+1);
```

The vectors `[1 2 3 4]`, `[4 3 6 5]` specifies which inputs and outputs, respectively, of L complete the feedback interconnection. For example, `feedback` uses output 4 and input 1 of L to create the first feedback interconnection. The function uses output 3 and input 2 to create the second interconnection, and so on.

T3 is a 5-input, 7-output state-space model. The closed-loop response from Azref to Az is `T3(6,5)`.

Compare the step response from Azref to Az to confirm that the three approaches yield the same results.

```
step(T1,T2('Az','Azref'),T3(6,5),2)
```

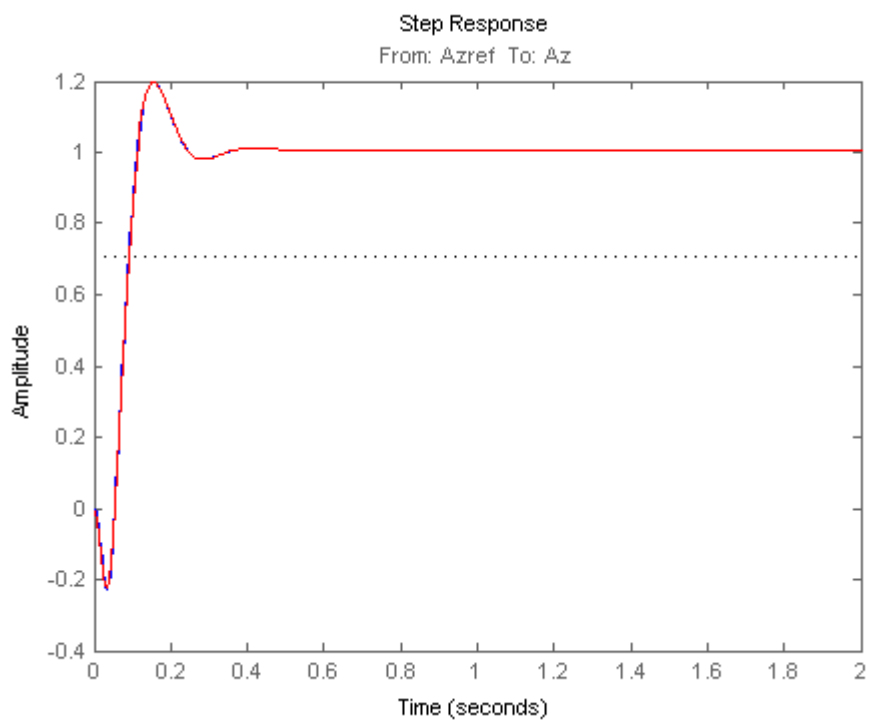
How the Software Determines Properties of Connected Models

When you interconnect models, the operation and the properties of the models you are connecting determine the resulting model's properties. The following table summarizes some general rules governing how resulting model property values are determined.

Property	Expected Behavior
Ts	When connecting discrete-time models, all models must have identical or unspecified (<code>sys.Ts = -1</code>) sampling time. The resulting model inherits the sampling time from the connected models.
InputName OutputName InputGroup InputGroup	In general, the resulting model inherits I/O names and I/O groups from connected models. However, conflicting I/O names or I/O groups are not inherited. For example, the <code>InputName</code> property for <code>sys1 + sys2</code> is left unspecified if <code>sys1</code> and <code>sys2</code> have different <code>InputName</code> property values.
TimeUnit	All connected models must have identical <code>TimeUnit</code> properties. The resulting model inherits its <code>TimeUnit</code> from the connected models.
Variable	A model resulting from operations on <code>tf</code> or <code>zpk</code> models inherits its <code>Variable</code> property value from the operands. Conflicts are resolved according the following rules: <ul style="list-style-type: none"> • For continuous-time models, 'p' has precedence over 's'.

Property	Expected Behavior
	<ul style="list-style-type: none">• For discrete-time models, 'q^{-1}' and 'z^{-1}' have precedence over 'q' and 'z', while 'q' has precedence over 'z'.
Notes UserData	Most operations ignore the Notes and UserData properties. These properties of the resulting model are empty.

Precedence Rules That Determine Model Type

This example explains the precedence rules that determine the type of model that results when you interconnect models of different types.

When you combine Numeric LTI models other than `frd` models, the resulting model is determined by the following order of precedence:

```
ss > zpk > tf > pid > pidstd
```

For example, connect an `ss` model with a `pid` model.

```
P = ss([-0.8,0.4;0.4,-1.0],[-3.0;1.4],[0.3,0],0);  
C = pid(-0.13,-0.61);  
CL = feedback(P1*C1,1)
```

The `ss` model has the highest precedence among Numeric LTI models. Therefore, combining `P` and `C` with any model interconnection command returns an `ss` model.

Combining Numeric LTI models with Generalized LTI models or with Control Design Blocks results in Generalized LTI models.

For example, connect the `ss` model `CL` with a Control Design Block.

```
F = ltiblock.tf('F',0,1);  
CLF = F*CL
```

`CLF` is a `genss` model.

Any connection that includes a frequency-response model (`frd` or `genfrd`) results in a frequency-response model.

Note The software automatically converts all models to the resulting model type before performing the connection operation.

Recommended Model Type for Building Block Diagrams

This example shows how choice of model type can affect numerical accuracy when interconnecting models.

You can represent block diagram components with any model type. However, certain connection operations yield better numerical accuracy for models in `ss` form.

For example, interconnect two models in series using different model types to see how different representations introduce numerical inaccuracies.

Load the models `Pd` and `Cd`, which are ninth-order and second-order discrete-time transfer functions, respectively.

```
load numdemo Pd Cd
```

Compute the open-loop transfer function $L = Pd * Cd$ using the `tf`, `zpk`, `ss`, and `frd` representations.

```
Ltf = Pd*Cd;  
Lzp = zpk(Pd)*Cd;  
Lss = ss(Pd)*Cd;
```

```
w = logspace(-1,3,100);  
Lfrd = frd(Pd,w)*Cd;
```

Plot the magnitude of the frequency response to compare the four representations.

```
bodemag(Ltf,Lzp,Lss,Lfrd)  
legend('tf','zpk','ss','frd')
```

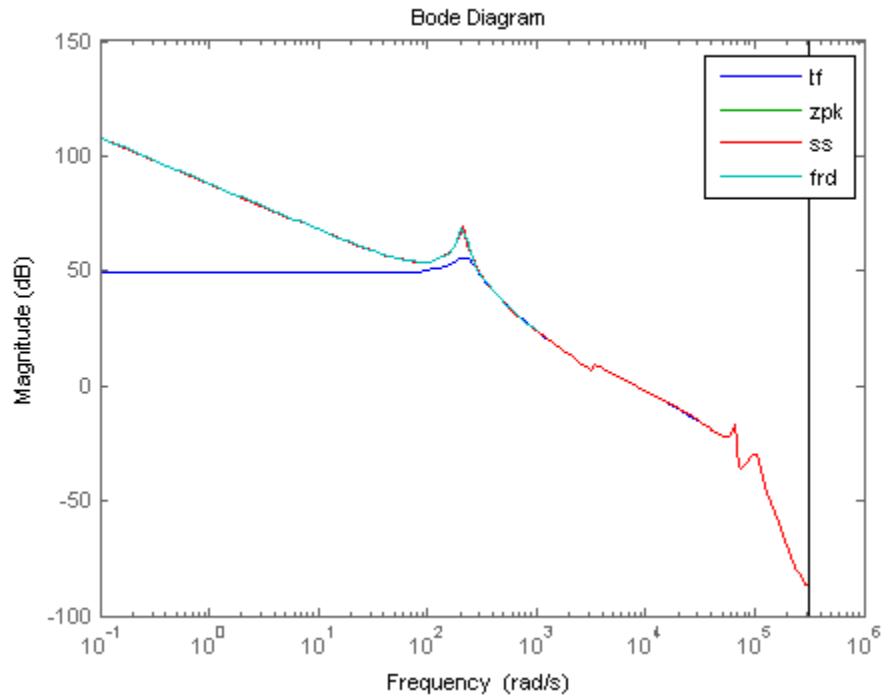

The tf representation has lost low-frequency dynamics that other representations preserve.

Model Transformation

- “Conversion Between Model Types” on page 5-2
- “Discretize a Compensator” on page 5-6
- “Improve Accuracy of Discretized System with Time Delay” on page 5-11
- “Convert Discrete-Time System to Continuous Time” on page 5-16
- “Continuous-Discrete Conversion Methods” on page 5-19
- “Upsample a Discrete-Time System” on page 5-29
- “Choosing a Resampling Command” on page 5-33
- “Why Simplify Models?” on page 5-34
- “Cancellation Versus Approximation” on page 5-35
- “Approximate Model with Lower-Order Model” on page 5-37
- “Choose a Low-Order Approximation Method” on page 5-42
- “Approximate Model with Unstable or Near-Unstable Pole” on page 5-47
- “Eliminate States by Pole-Zero Cancellation” on page 5-51

Conversion Between Model Types

In this section...

“Explicit Conversion Between Model Types” on page 5-2

“Automatic Conversion Between Model Types” on page 5-2

“Recommended Working Representation” on page 5-3

“Convert PID Controller to Transfer Function” on page 5-4

“Get Current Value of Generalized Model by Model Conversion” on page 5-4

Explicit Conversion Between Model Types

You can explicitly convert a model from one representation to another using the model-creation command for the target model type. For example, convert to state-space representation using `ss`, and convert to parallel-form PID using `pid`. For information about converting to a particular model type, see the reference page for that model type.

In general, you can convert from any model type to any other. However, there are a few limitations. For example, you cannot convert:

- `frd` models to analytic model types such as `ss`, `tf`, or `zpk` (unless you perform system identification with System Identification Toolbox software).
- `ss` models with internal delays to `tf` or `zpk`.

You can convert between Numeric LTI models and Generalized LTI models.

- Converting a Generalized LTI model to a Numeric LTI model evaluates any Control Design Blocks at their current (nominal) value.
- Converting a Numeric LTI model to a Generalized LTI model creates a Generalized LTI model with an empty `Blocks` property.

Automatic Conversion Between Model Types

Some algorithms operate only on one type of model object. For example, the algorithm for zero-order-hold discretization with `c2d` can only be performed on state-space models. Similarly, commands such as `tfdata` or `piddata`

expect a particular type of model (`tf` or `pid`, respectively). For convenience, such commands automatically convert input models to the appropriate or required model type. For example:

```
sys = ss(0,1,1,0)
[num,den] = tfdata(sys)
```

`tfdata` automatically converts the state-space model `sys` to transfer function form to return numerator and denominator data.

Conversions to state-space form are not uniquely defined. For this reason, automatic conversions to state space do not occur when the result depends on the choice of state coordinates. For example, the `initial` and `kalman` commands require state-space models.

Recommended Working Representation

You can represent numeric system components using any model type. However, Numeric LTI model types are not equally well-suited for numerical computations. In general, it is recommended that you work with state-space (`ss`) or frequency response data (`frd`) models, for the following reasons:

- The accuracy of computations using high-order transfer functions (`tf` or `zpk` models) is sometimes poor, particularly for MIMO or high-order systems. Conversions to a transfer function representation can incur a loss of accuracy.
- When you convert `tf` or `zpk` models to state space using `ss`, the software automatically performs balancing and scaling operations. Balancing and scaling improves the numeric accuracy of computations involving the model. For more information about balancing and scaling state-space models, see “Scaling State-Space Models” on page 16-2.

In addition, converting back and forth between model types can introduce additional states or orders, or introduce numeric inaccuracies. For example, conversions to state space are not uniquely defined, and are not guaranteed to produce a minimal realization for MIMO models. For a given state-space model `sys`,

```
ss(tf(sys))
```

can return a model with different state-space matrices, or even a different number of states in the MIMO case.

Convert PID Controller to Transfer Function

This example shows how to convert a PID controller model to a transfer function model.

You can use the technique of this example to convert any type of model to another type of model.

Create a PID controller.

```
pid_sys = pid(1,1.5,3);
```

Convert `pid_sys` to a transfer function model using `tf`.

```
C = tf(pid_sys);
```

`C` is a `tf` model representation of `pid_sys`.

You can similarly convert transfer function models to `pid` models, provided the `tf` model object represents a parallel-form PID controller with $Tf \geq 0$.

Get Current Value of Generalized Model by Model Conversion

This example shows how to get the current value of a generalized model by converting it to a numeric model.

Generalized models are used to model systems with tunable and/or uncertain parameters.

Create a generalized model.

Represent the transfer function

$$F = \frac{a}{s + a}$$

containing a real, tunable parameter, `a`, which is initialized to 10.

```
a = realp('a',10);
F = tf(a,[1 a]);
```

F is a genss model parameterized by a.

Tune the generalized model.

Commands such as `looptune` and `hinfstruct` can be used to tune the parameters of a generalized model.

For this example, change the value of the tunable component of F.

```
F.Blocks.a.Value = 5;
```

Get the current value of the generalized model.

Get the current value of the generalized model by converting it to a numeric model.

```
F_cur_val = tf(F)
```

```
F_cur_val =
```

```
    5
  ----
  s + 5
```

Continuous-time transfer function.

`tf(F)` converts the generalized model, F, to a numeric transfer function, `F_cur_val`.

To view the state-space representation of the current value of F, type `ss(F)`.

Tip To examine the current value of all tunable components in a generalized model, use `showBlockValue`.

Discretize a Compensator

This example shows how to convert a compensator from continuous to discrete time using several discretization methods, to identify a method that yields a good match in the frequency domain.

You might design a compensator in continuous time, and then need to convert it to discrete time for a digital implementation. When you do so, you want the discretization to preserve frequency-domain characteristics that are essential to your performance and stability requirements.

In the following control system, G is a continuous-time second-order system with a sharp resonance around 3 rad/s.

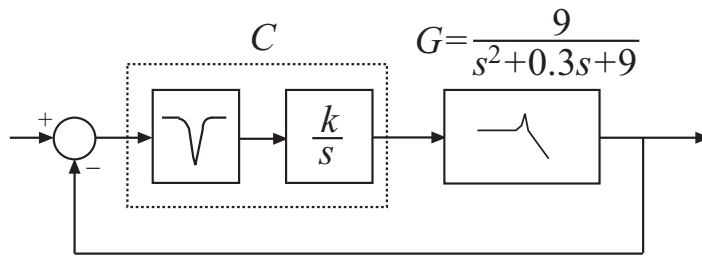

One valid controller for this system includes a notch filter in series with an integrator. Create a model of this controller.

```
notch = tf([1,0.5,9],[1,5,9]);
integ = pid(0,0.34);
C = integ*notch;
bode(C)
```

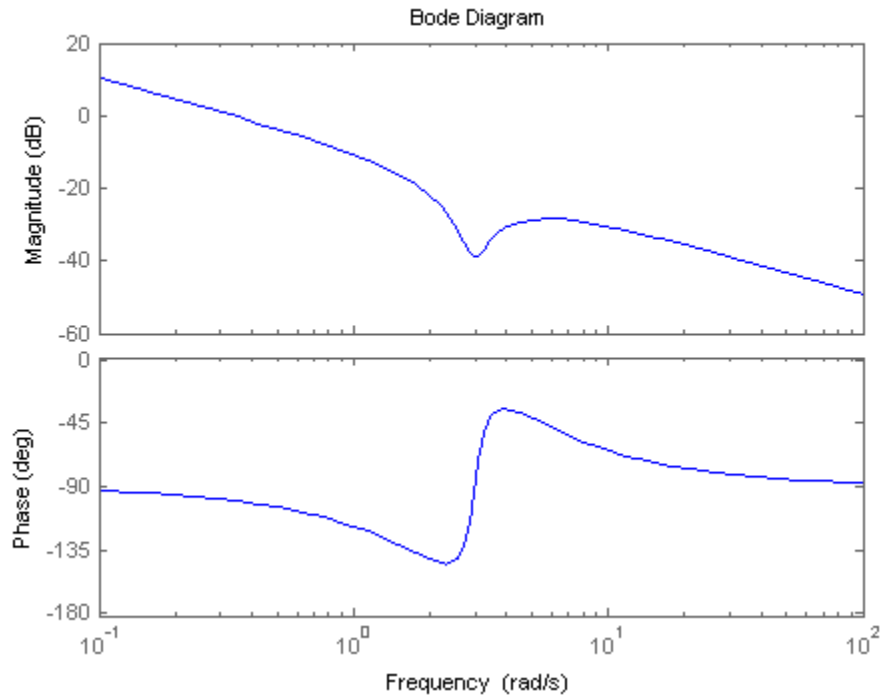

The notch filter centered at 3 rad/s counteracts the effect of the resonance in G . This configuration allows higher loop gain for a faster overall response.

Discretize the compensator.

```
Cdz = c2d(C,0.5);
```

The `c2d` command supports several different discretization methods. Since this command does not specify a method, `c2d` uses the default method, Zero-Order Hold (ZOH). In the ZOH method, the time-domain response of the discretized compensator matches the continuous-time response at each time step.

The discretized controller Cdz has a sampling time of 0.5 s. In practice, the sampling time you choose might be constrained by the system in which you implement your controller, or by the bandwidth of your control system.

Compare the frequency-domain response of C and Cdz .

```
bode(C,Cdz)
legend('C','Cdz');
```

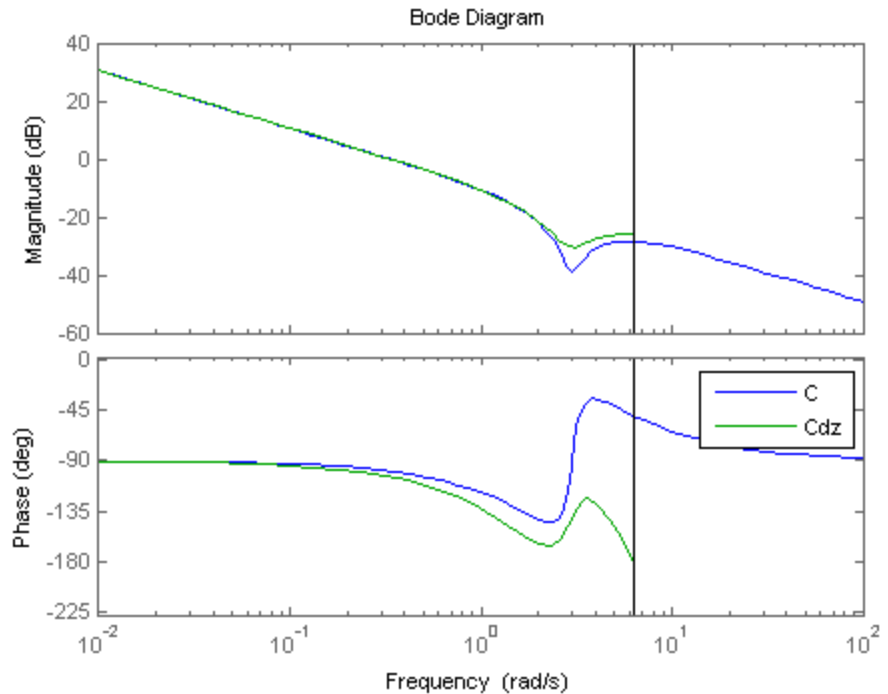

The vertical line marks the Nyquist frequency, π/T_s , where T_s is the sampling time. Near the Nyquist frequency, the response of the discretized compensator is distorted relative to the continuous-time response. As a result, the discretized notched filter may not properly counteract the plant resonance.

To fix this, try discretizing the compensator using the Tustin method and compare to the ZOH result. The Tustin discretization method often yields a better match in the frequency domain than the ZOH method.

```
Cdt = c2d(C,0.5,'tustin');
plotopts = bodeoptions;
```

```

plotopts.Ylim = {[ -60,40],[ -225,0]};
bodeplot(C,Cdz,Cdt,plotopts)
legend('C','Cdz','Cdt')

```

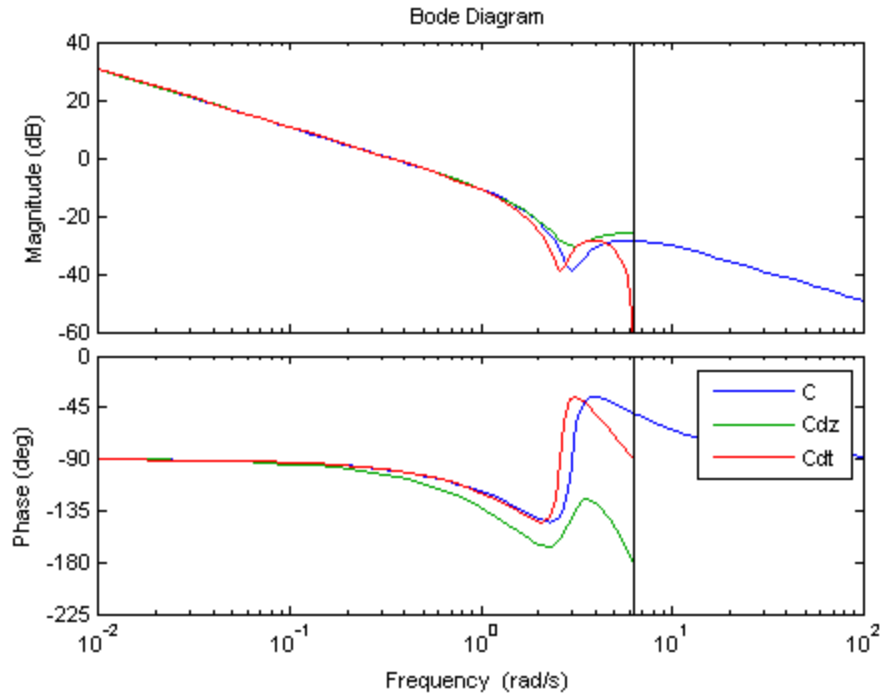

The Tustin method preserves the depth of the notch. However, the method introduces a frequency shift that is unacceptable for many applications. You can remedy the frequency shift by specifying the notch frequency as the prewarping frequency in the Tustin transform.

Discretize the compensator using the Tustin method with frequency prewarping, and compare the results.

```

discopts = c2dOptions('Method','tustin','PrewarpFrequency',3.0);
CdtP = c2d(C,0.5,discopts);
bodeplot(C,Cdt,CdtP,plotopts)
legend('C','Cdt','CdtP')

```

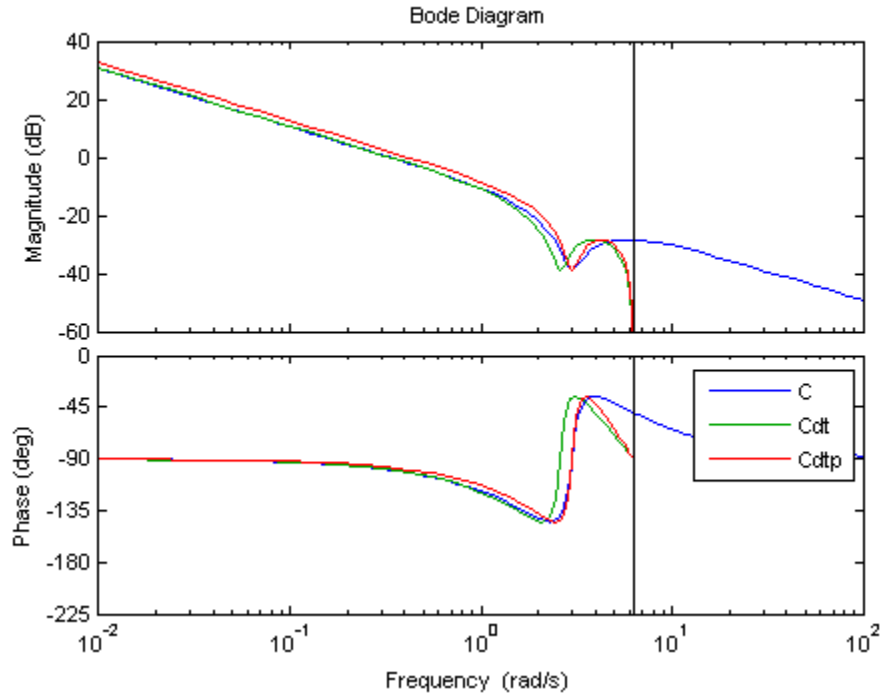

To specify additional discretization options beyond the discretization method, use `c2dOptions`. Here, the discretization options set `discopts` specifies both the Tustin method and the prewarp frequency. The prewarp frequency is 3.0 rad/s, the frequency of the notch in the compensator response.

Using the Tustin method with frequency prewarping yields a better-matching frequency response than Tustin without prewarping.

See Also

`c2d` | `c2dOptions`

Related Examples

- “Improve Accuracy of Discretized System with Time Delay” on page 5-11

Concepts

- “Continuous-Discrete Conversion Methods” on page 5-19

Improve Accuracy of Discretized System with Time Delay

This example shows how to improve the frequency-domain accuracy of a system with a time delay that is a fractional multiple of the sampling time.

When you discretize a system with a time delay that is an integer multiple of the sampling time, the time delay converts to factors of z^{-1} (poles at $z = 0$). For example, if you use a sampling time of 0.1 s to discretize a transfer function having a time delay of 0.6 s, the discretized transfer function includes an extra factor of z^{-6} .

For systems with time delays that are not integer multiples of the sampling time, the `Tustin` and `Matched` methods by default round the time delays to the nearest multiple of the sampling period. To improve the accuracy of these methods for such systems, `c2d` can optionally approximate the fractional portion of the time delay by a discrete-time all-pass filter (a Thiran filter).

In this example, discretize the system both without and with an approximation of the fractional portion of the delay and compare the results.

Create a continuous-time transfer function with a transfer delay of 2.5 s.

```
G = tf(1,[1,0.2,4], 'ioDelay',2.5);
```

Discretize `G` using a sampling time of 1 s.

`G` has a sharp resonance at 2 rad/s. At a sampling time of 1 s, that peak is close to the Nyquist frequency. For a frequency-domain match that preserves dynamics near the Nyquist frequency, use the `Tustin` method with prewarp frequency 2 rad/s. Specify the discretization method and prewarp frequency using an options set you define with the `c2dOptions` command.

```
discopts = c2dOptions('Method','tustin','PrewarpFrequency',2);
Gt = c2d(G,1,discopts)
```

Warning: Rounding delays to the nearest multiple of the sampling period. For more accuracy in the time domain, use the ZOH or FOH methods. For more accuracy in the frequency domain, use Thiran filters to approximate the fractional delays (type "help c2dOptions" for more details).

```
> In warning at 26
```

```
In zpkdata.c2d>handleFractionalDelays at 173
In zpkdata.c2d at 117
In tfdata.c2d at 14
In SystemArray>SystemArray.c2d_ at 355
In tf.tf>tf.c2d_ at 776
In DynamicSystem.c2d at 90
```

Gt =

$$z^{(-3)} * \frac{0.1693 z^2 + 0.3386 z + 0.1693}{z^2 + 0.7961 z + 0.913}$$

Sample time: 1 seconds
Discrete-time transfer function.

The software warns you that it rounds the fractional time delay to the nearest multiple of the sampling time. In this example, the time delay of 2.5 sampling periods (2.5 s) converts to an additional factor of $z^{(-3)}$ in Gt.

Compare Gt to the continuous-time system G.

```
plotopts = bodeoptions;
plotopts.Ylim = {[ -100,20],[ -1080,0]};
bodeplot(G,Gt,plotopts);
legend('G','Gt')
```

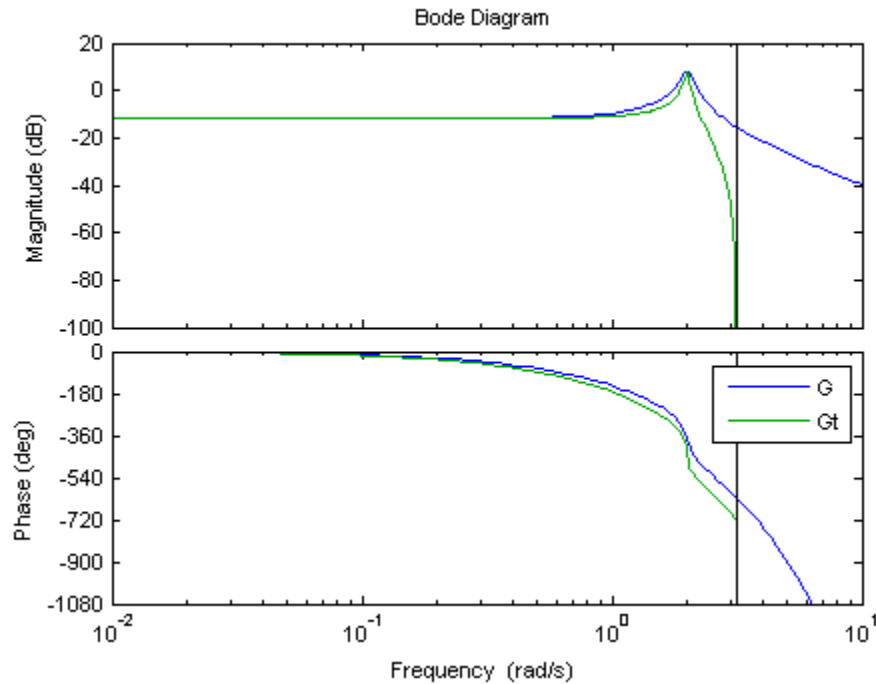

There is a phase lag between the discretized system G_t and the continuous-time system G , which grows as the frequency approaches the Nyquist frequency. This phase lag is largely due to the rounding of the fractional time delay. In this example, the fractional time delay is half a sampling period.

If your application requires accurate frequency-matching near the Nyquist frequency, you can specify that `c2d` approximate the fractional portion of the time delay as a discrete-time all-pass filter (Thiran filter).

Discretize G again using a third-order Thiran filter to approximate the half-period portion of the delay.

```
discopts.FractDelayApproxOrder = 3;
Gtf = c2d(G,1,discopts);
```

Setting `FractDelayApproxOrder` to 3 in the `c2d` options set `discopts` specifies that the fractional portion of the time delay is approximated by a third-order Thiran filter. The other options in `discopts` are unchanged. Thus `Gtf` is a Tustin discretization of `G` with prewarp at 2 rad/s.

Compare `Gtf` to `G` and `Gt`.

```
plotopts.PhaseMatching = 'on';
bodeplot(G,Gt,Gtf,plotopts);
legend('G','Gt','Gtf','Location','SouthWest')
```

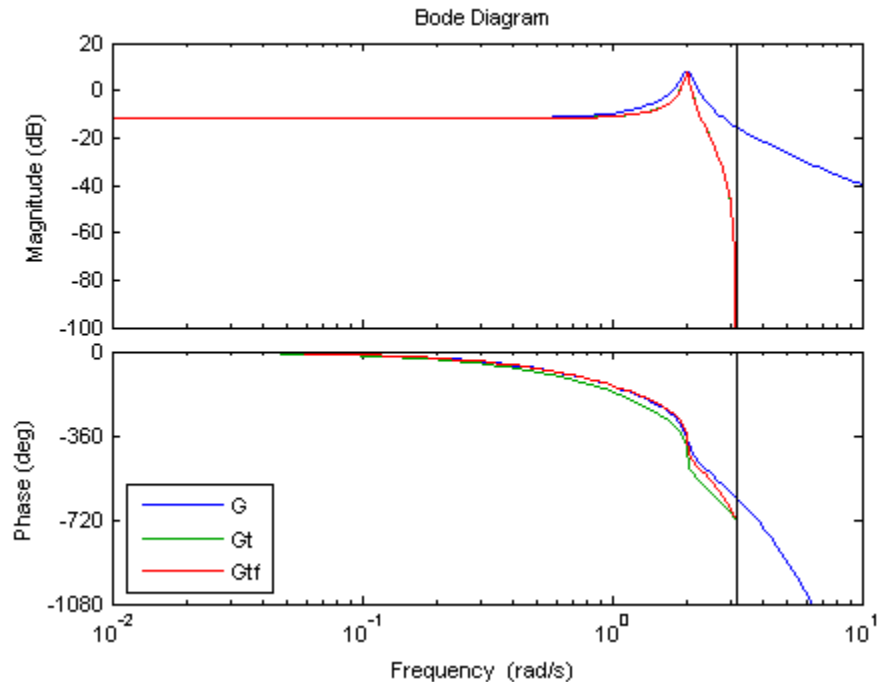

The magnitudes of `Gt` and `Gtf` are identical. However, the phase of `Gtf` provides a better match to the phase of the continuous-time system through the resonance. As the frequency approaches the Nyquist frequency, this phase match deteriorates. A higher-order approximation of the fractional delay would improve the phase matching closer to the Nyquist frequencies.

However, each additional order of approximation adds an additional order (or state) to the discretized system.

See Also

`c2d` | `c2dOptions` | `thiran`

Related Examples

- “Discretize a Compensator” on page 5-6

Concepts

- “Continuous-Discrete Conversion Methods” on page 5-19

Convert Discrete-Time System to Continuous Time

This example shows how to convert a discrete-time system to continuous time using `d2c`, and compares the results using two different interpolation methods.

Convert the second-order discrete-time system

$$G(z) = \frac{z + 0.5}{(z + 2)(z - 5)}$$

to continuous time using the zero-order hold (ZOH) method.

```
G = zpk(-0.5, [-2,5], 1, 0.1);
Gcz = d2c(G)
```

```
Warning: The model order was increased to handle real negative poles.
> In warning at 26
  In ssdata.utInvDiscretizeZOH at 74
  In ssdata.d2c at 24
  In zpkdata.d2c at 156
  In SystemArray>SystemArray.d2c_ at 367
  In zpk.zpk>zpk.d2c_ at 823
  In DynamicSystem.d2c at 69
```

```
Gcz =
```

```
  2.6663 (s^2 + 14.28s + 780.9)
-----
(s-16.09) (s^2 - 13.86s + 1035)
```

```
Continuous-time zero/pole/gain model.
```

When you call `d2c` without specifying a method, the function uses ZOH by default. The ZOH interpolation method increases the model order for systems that have real negative poles. This order increase occurs because the interpolation algorithm maps real negative poles in the z domain to pairs of complex conjugate poles in the s domain.

Convert G to continuous time using the Tustin method.

```
Gct = d2c(G, 'tustin')
```

```
Gct =
```

$$\frac{0.083333 (s+60) (s-20)}{(s-60) (s-13.33)}$$

Continuous-time zero/pole/gain model.

In this case, there is no order increase.

Compare frequency responses of the interpolated systems with that of G.

```
bode(G,Gcz,Gct)
legend('G','Gcz','Gct')
```

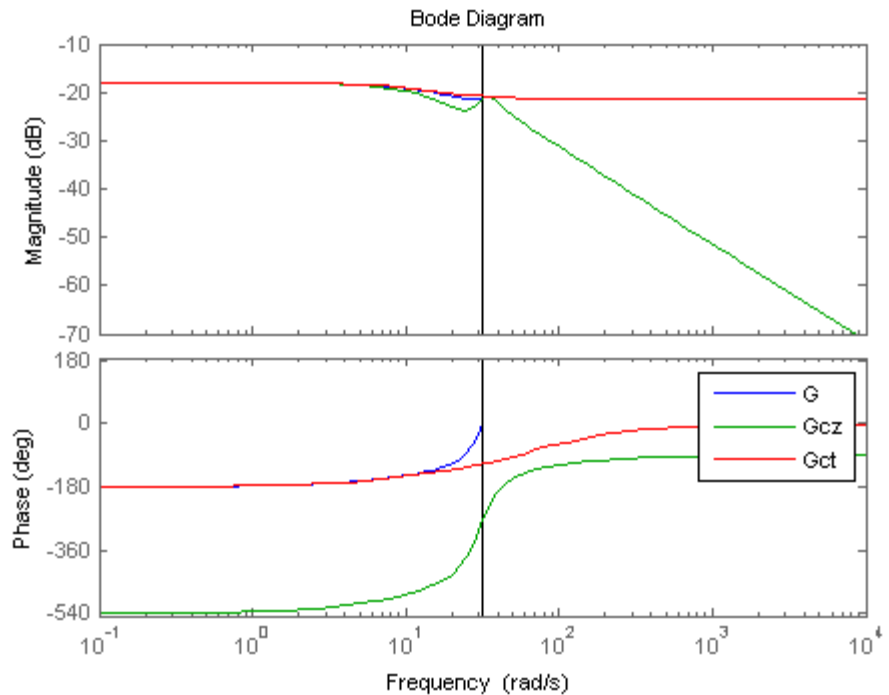

In this case, the Tustin method provides a better frequency-domain match between the discrete system and the interpolation. However, the Tustin interpolation method is undefined for systems with poles at $z = -1$ (integrators), and is ill-conditioned for systems with poles near $z = -1$.

See Also

d2c | d2cOptions

Related Examples

- “Discretize a Compensator” on page 5-6

Concepts

- “Continuous-Discrete Conversion Methods” on page 5-19

Continuous-Discrete Conversion Methods

In this section...
“Choosing a Conversion Method” on page 5-19
“Zero-Order Hold” on page 5-20
“First-Order Hold” on page 5-22
“Impulse-Invariant Mapping” on page 5-23
“Tustin Approximation” on page 5-24
“Zero-Pole Matching Equivalents” on page 5-27

Choosing a Conversion Method

The `c2d` command discretizes continuous-time models. Conversely, `d2c` converts discrete-time models to continuous time. Both commands support several discretization and interpolation methods, as shown in the following table.

Discretization Method	Use when:
“Zero-Order Hold” on page 5-20	You want an exact discretization in the time domain for staircase inputs.
“First-Order Hold” on page 5-22	You want an exact discretization in the time domain for piecewise linear inputs.
“Impulse-Invariant Mapping” on page 5-23 (c2d only)	You want an exact discretization in the time domain for impulse train inputs.

Discretization Method	Use when:
“Tustin Approximation” on page 5-24	<ul style="list-style-type: none"> You want good matching in the frequency domain between the continuous- and discrete-time models. Your model has important dynamics at some particular frequency.
“Zero-Pole Matching Equivalents” on page 5-27	You have a SISO model, and you want good matching in the frequency domain between the continuous- and discrete-time models.

Zero-Order Hold

The Zero-Order Hold (ZOH) method provides an exact match between the continuous- and discrete-time systems in the time domain for staircase inputs.

The following block diagram illustrates the zero-order-hold discretization $H_d(z)$ of a continuous-time linear model $H(s)$

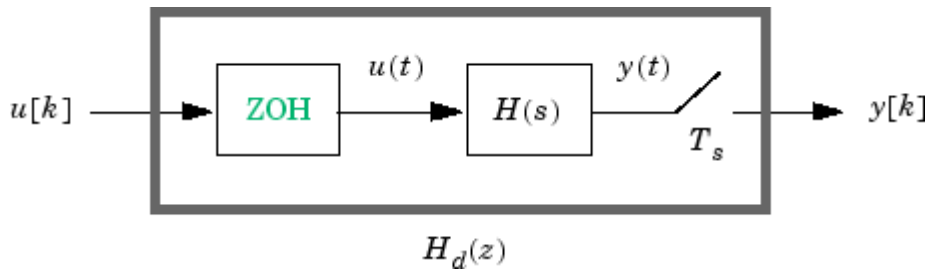

The ZOH block generates the continuous-time input signal $u(t)$ by holding each sample value $u(k)$ constant over one sample period:

$$u(t) = u[k], \quad kT_s \leq t \leq (k+1)T_s$$

The signal $u(t)$ is the input to the continuous system $H(s)$. The output $y[k]$ results from sampling $y(t)$ every T_s seconds.

Conversely, given a discrete system $H_d(z)$, d2c produces a continuous system $H(s)$. The ZOH discretization of $H(s)$ coincides with $H_d(z)$.

The ZOH discrete-to-continuous conversion has the following limitations:

- d2c cannot convert LTI models with poles at $z = 0$.
- For discrete-time LTI models having negative real poles, ZOH d2c conversion produces a continuous system with higher order. The model order increases because a negative real pole in the z domain maps to a pure imaginary value in the s domain. Such mapping results in a continuous-time model with complex data. To avoid this, the software instead introduces a conjugate pair of complex poles in the s domain. See “Convert Discrete-Time System to Continuous Time” on page 5-16 for an example.

ZOH Method for Systems with Time Delays

You can use the ZOH method to discretize SISO or MIMO continuous-time models with time delays. The ZOH method yields an exact discretization for systems with input delays, output delays, or transfer delays.

For systems with internal delays (delays in feedback loops), the ZOH method results in approximate discretizations. The following figure illustrates a system with an internal delay.

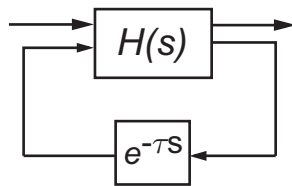

For such systems, c2d performs the following actions to compute an approximate ZOH discretization:

- 1 Decomposes the delay τ as $\tau = kT_s + \rho$ with $0 \leq \rho < T_s$.
- 2 Absorbs the fractional delay ρ into $H(s)$.
- 3 Discretizes $H(s)$ to $H(z)$.

- 4 Represents the integer portion of the delay kT_s as an internal discrete-time delay z^{-k} . The final discretized model appears in the following figure:

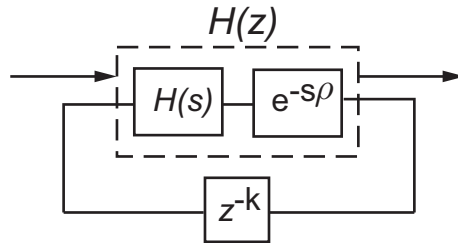

First-Order Hold

The First-Order Hold (FOH) method provides an exact match between the continuous- and discrete-time systems in the time domain for piecewise linear inputs.

FOH differs from ZOH by the underlying hold mechanism. To turn the input samples $u[k]$ into a continuous input $u(t)$, FOH uses linear interpolation between samples:

$$u(t) = u[k] + \frac{t - kT_s}{T_s} (u[k+1] - u[k]), \quad kT_s \leq t \leq (k+1)T_s$$

This method is generally more accurate than ZOH for systems driven by smooth inputs.

This FOH method differs from standard causal FOH and is more appropriately called *triangle approximation* (see [2], p. 228). The method is also known as ramp-invariant approximation.

FOH Method for Systems with Time Delays

You can use the FOH method to discretize SISO or MIMO continuous-time models with time delays. The FOH method handles time delays in the same way as the ZOH method. See “ZOH Method for Systems with Time Delays” on page 5-21.

Impulse-Invariant Mapping

The impulse-invariant mapping produces a discrete-time model with the same impulse response as the continuous time system. For example, compare the impulse response of a first-order continuous system with the impulse-invariant discretization:

```
G = tf(1,[1,1]);  
Gd1 = c2d(G,0.01,'impulse');  
impz(G,Gd1)
```

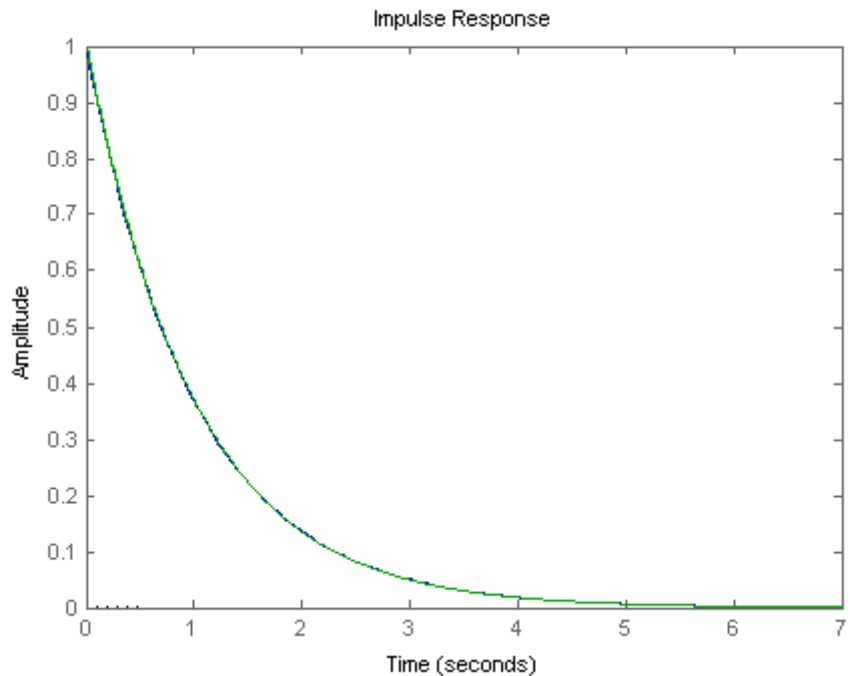

The impulse response plot shows that the impulse responses of the continuous and discretized systems match.

Impulse-Invariant Mapping for Systems with Time Delays

You can use impulse-invariant mapping to discretize SISO or MIMO continuous-time models with time delay, except that the method does not support ss models with internal delays. For supported models, impulse-invariant mapping yields an exact discretization of the time delay.

Tustin Approximation

The Tustin or bilinear approximation yields the best frequency-domain match between the continuous-time and discretized systems. This method relates the s -domain and z -domain transfer functions using the approximation:

$$z = e^{sT_s} \approx \frac{1 + sT_s / 2}{1 - sT_s / 2}.$$

In c2d conversions, the discretization $H_d(z)$ of a continuous transfer function $H(s)$ is:

$$H_d(z) = H(s'), \quad s' = \frac{2}{T_s} \frac{z-1}{z+1}$$

Similarly, the d2c conversion relies on the inverse correspondence

$$H(s) = H_d(z'), \quad z' = \frac{1 + sT_s / 2}{1 - sT_s / 2}$$

When you convert a state-space model using the Tustin method, the states are not preserved. The state transformation depends upon the state-space matrices and whether the system has time delays. For example, for an explicit ($E = I$) continuous-time model with no time delays, the state vector $w[k]$ of the discretized model is related to the continuous-time state vector $x(t)$ by:

$$w[kT_s] = \left(I - A \frac{T_s}{2} \right) x(kT_s) - \frac{T_s}{2} Bu(kT_s) = x(kT_s) - \frac{T_s}{2} (Ax(kT_s) + Bu(kT_s)).$$

T_s is the sampling time of the discrete-time model. A and B are state-space matrices of the continuous-time model.

Tustin Approximation with Frequency Prewarping

If your system has important dynamics at a particular frequency that you want the transformation to preserve, you can use the Tustin method with frequency prewarping. This method ensures a match between the continuous- and discrete-time responses at the prewarp frequency.

The Tustin approximation with frequency prewarping uses the following transformation of variables:

$$H_d(z) = H(s'), \quad s' = \frac{\omega}{\tan(\omega T_s / 2)} \frac{z-1}{z+1}$$

This change of variable ensures the matching of the continuous- and discrete-time frequency responses at the prewarp frequency ω , because of the following correspondence:

$$H(j\omega) = H_d(e^{j\omega T_s})$$

Tustin Approximation for Systems with Time Delays

You can use the Tustin approximation to discretize SISO or MIMO continuous-time models with time delays.

By default, the Tustin method rounds any time delay to the nearest multiple of the sampling time. Therefore, for any time delay τ , the integer portion of the delay, kT_s , maps to a delay of k sampling periods in the discretized model. This approach ignores the residual fractional delay, $\tau - kT_s$.

You can approximate the fractional portion of the delay by a discrete all-pass filter (Thiran filter) of specified order. To do so, use the `FractDelayApproxOrder` option of `c2dOptions`. See “Improve Accuracy of Discretized System with Time Delay” on page 5-11 for an example.

To understand how the Tustin method handles systems with time delays, consider the following SISO state-space model $G(s)$. The model has input delay τ_i , output delay τ_o , and internal delay τ .

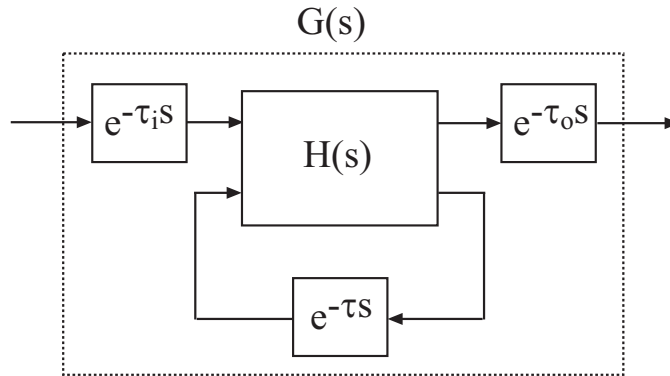

The following figure shows the general result of discretizing $G(s)$ using the Tustin method.

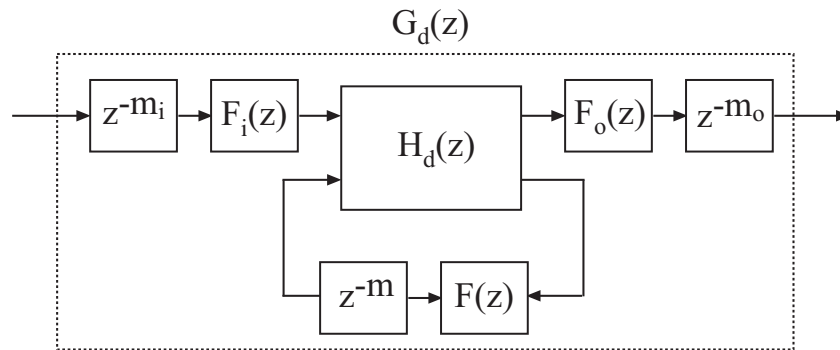

By default, `c2d` converts the time delays to pure integer time delays. The `c2d` command computes the integer delays by rounding each time delay to the nearest multiple of the sample time T_s . Thus, in the default case, $m_i = \text{round}(\tau_i/T_s)$, $m_o = \text{round}(\tau_o/T_s)$, and $m = \text{round}(\tau/T_s)$. Also in this case, $F_i(z) = F_o(z) = F(z) = 1$.

If you set `FractDelayApproxOrder` to a non-zero value, `c2d` approximates the fractional portion of the time delays by Thiran filters $F_i(z)$, $F_o(z)$, and $F(z)$.

The Thiran filters add additional states to the model. The maximum number of additional states for each delay is `FractDelayApproxOrder`.

For example, for the input delay τ_i , the order of the Thiran filter $F_i(z)$ is:

$$\text{order}(F_i(z)) = \max(\text{ceil}(\tau_i/T_s), \text{FractDelayApproxOrder}).$$

If $\text{ceil}(\tau_i/T_s) < \text{FractDelayApproxOrder}$, the Thiran filter $F_i(z)$ approximates the entire input delay τ_i . If $\text{ceil}(\tau_i/T_s) > \text{FractDelayApproxOrder}$, the Thiran filter only approximates a portion of the input delay. In that case, `c2d` represents the remainder of the input delay as a chain of unit delays z^{-m} , where

$$m_i = \text{ceil}(\tau_i/T_s) - \text{FractDelayApproxOrder}.$$

`c2d` uses Thiran filters and `FractDelayApproxOrder` in a similar way to approximate the output delay τ_o and the internal delay τ .

When you discretize `tf` and `zpk` models using the Tustin method, `c2d` first aggregates all input, output, and transfer delays into a single transfer delay τ_{TOT} for each channel. `c2d` then approximates τ_{TOT} as a Thiran filter and a chain of unit delays in the same way as described for each of the time delays in `ss` models.

For more information about Thiran filters, see the `thiran` reference page and [4].

Zero-Pole Matching Equivalents

The method of conversion by computing zero-pole matching equivalents applies only to SISO systems. The continuous and discretized systems have matching DC gains. Their poles and zeros are related by the transformation:

$$z_i = e^{s_i T_s}$$

where:

- z_i is the i th pole or zero of the discrete-time system.
- s_i is the i th pole or zero of the continuous-time system.
- T_s is the sampling time.

See [2] for more information.

Zero-Pole Matching for Systems with Time Delays

You can use zero-pole matching to discretize SISO continuous-time models with time delay, except that the method does not support `ss` models with internal delays. The zero-pole matching method handles time delays in the same way as the Tustin approximation. See “Tustin Approximation for Systems with Time Delays” on page 5-25.

References

- [1] Åström, K.J. and B. Wittenmark, *Computer-Controlled Systems: Theory and Design*, Prentice-Hall, 1990, pp. 48-52.
- [2] Franklin, G.F., Powell, D.J., and Workman, M.L., *Digital Control of Dynamic Systems* (3rd Edition), Prentice Hall, 1997.
- [3] Smith, J.O. III, “Impulse Invariant Method”, *Physical Audio Signal Processing*, August 2007.
http://www.dsprelated.com/dspbooks/pasp/Impulse_Invariant_Method.html.
- [4] T. Laakso, V. Valimaki, “Splitting the Unit Delay”, *IEEE Signal Processing Magazine*, Vol. 13, No. 1, p.30-60, 1996.

See Also

`c2d` | `d2c` | `c2dOptions` | `d2cOptions` | `d2d` | `thiran`

Related Examples

- “Discretize a Compensator” on page 5-6
- “Improve Accuracy of Discretized System with Time Delay” on page 5-11
- “Convert Discrete-Time System to Continuous Time” on page 5-16

Upsample a Discrete-Time System

This example shows how to upsample a system using both the `d2d` and `upsample` commands and compares the results of both to the original system.

Upsampling a system can be useful, for example, when you need to implement a digital controller at a faster rate than you originally designed it for.

Create the discrete-time system $G(z) = \frac{z+0.4}{z-0.7}$ with a sampling time of 0.3 s.

```
G = tf([1,0.4],[1,-0.7],0.3);
```

Resample the system at 0.1 s using `d2d`.

```
G_d2d = d2d(h1,0.1)
```

```
G_d2d =
```

```
z - 0.4769
-----
z - 0.8879
```

```
Sample time: 0.1 seconds
Discrete-time transfer function.
```

By default, `d2d` uses the zero-order-hold (ZOH) method to resample the system. The resampled system has the same order as `G`.

Resample the system again at 0.1 s, using `upsample`.

```
G_up = upsample(h1,3)
```

```
G_up =
```

```
z^3 + 0.4
-----
z^3 - 0.7
```

The second input, 3, tells `upsample` to resample `G` at a sampling time three times faster than the sampling time of `G`. This input to `upsample` must be an integer.

`G_up` has three times as many poles and zeroes as `G`.

Compare the step responses of the original model `G` with the resampled models `G_d2d` and `G_up`.

```
step(G, '-r', G_d2d, ':g', G_up, '--b')
legend('G', 'd2d', 'upsample', 'Location', 'SouthEast')
```

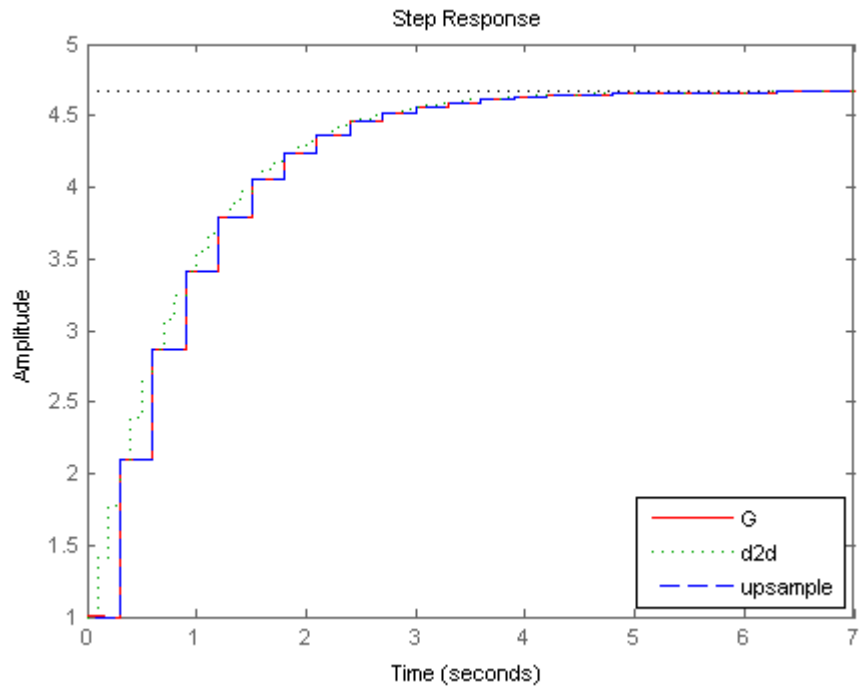

The step response of the upsampled model `G_up` matches exactly the step response of the original model `G`. The response of the resampled model `G_d2d` matches only at every third sample.

Compare the frequency response of the original model with the resampled models.

```
bode(G, '-r', G_d2d, ':g', G_up, '--b')
legend('G', 'd2d', 'upsample', 'Location', 'SouthWest')
```

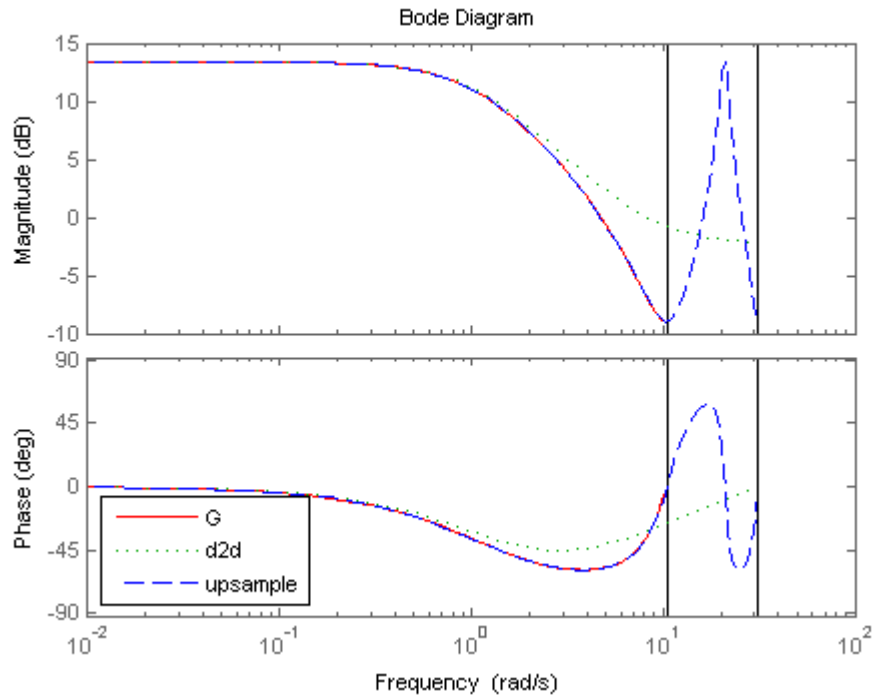

In the frequency domain as well, the model `G_up` created with the `upsample` command matches the original model exactly up to the Nyquist frequency of the original model.

Using `upsample` provides a better match than `d2d` in both the time and frequency domains. However, `upsample` increases the model order, which can be undesirable. Additionally, `upsample` is only available where the original sampling time is an integer multiple of the new sampling time.

See Also

d2d | d2dOptions | upsample

Concepts

- “Choosing a Resampling Command” on page 5-33

Choosing a Resampling Command

You can resample a discrete-time model using the commands described in the following table.

To...	Use the command...
<ul style="list-style-type: none"> Downsample a system. Upsample a system without any restriction on the new sampling time. 	d2d
Upsample a system with the highest accuracy when: <ul style="list-style-type: none"> The new sample time is integer-value-times faster than the sample time of the original model. Your new model can have more states than the original model. 	upsample

See Also

d2d | d2dOptions | upsample

Related Examples

- “Upsample a Discrete-Time System” on page 5-29

Why Simplify Models?

Working with simpler models result in faster and more reliable computations than higher-order models. Simpler models are also easier to understand and manipulate. Therefore, it can be useful to reduce model order while preserving model characteristics that are important to your application.

Some cases where you might want to reduce model order include:

- You are working with a relatively high-order model obtained from linearizing a Simulink model, performing a finite-element calculation, identification with System Identification Toolbox software, or other source.
- You design a high-order controller that you wish to implement as a lower-order controller (such as a PID controller). For example, controller design using Linear-Quadratic-Gaussian methods or H_∞ synthesis techniques can yield a high-order result. In this case, you might reduce the plant order before synthesis, reduce the controller order after synthesis, or both.
- You want to improve the simulation speed of a Simulink model at a certain operating point. In that case, you can linearize a portion of the model at that operating point and compute a reduced-order simplification or approximation of the linearized model. You can then replace the portion of the model with an LTI Block containing the reduced-order model.

In general, when you reduce model order, you want to preserve model characteristics that are important for your application. For example, for control design, you should verify that the behavior of the reduced order model adequately matches the behavior of the original model where the open-loop gain is close to 1 (in the gain crossover region).

Related Examples

- “Approximate Model with Lower-Order Model” on page 5-37
- “Approximate Model with Unstable or Near-Unstable Pole” on page 5-47
- “Eliminate States by Pole-Zero Cancellation” on page 5-51

Concepts

- “Cancellation Versus Approximation” on page 5-35

Cancellation Versus Approximation

To reduce the order of a model, you can either simplify your model, or compute a lower-order approximation. The following table summarizes the differences among several model-reduction approaches.

Approach	Commands
<p>Simplification — Reduce model order exactly by canceling pole-zero pairs or eliminating states that have no effect on the overall model response</p>	<ul style="list-style-type: none"> • <code>smnreal</code> — Eliminate states that are structurally disconnected from the inputs or outputs. Eliminating structurally disconnected states is a good first step in model reduction because the process does not involve any numerical computation. • <code>minreal</code> — Eliminate canceling or near-canceling pole-zero pairs from transfer functions. Eliminate unobservable or uncontrollable states from state-space models.
<p>Approximation — compute a lower-order approximation</p>	<p><code>balred</code> — Compute a lower-order approximation of your model by neglecting states that have relatively low effect on the overall model response</p>

In some cases, approximation can yield better results, even if the model looks like a good candidate for simplification. For example, models with near pole-zero cancellations may be better reduced by approximation than simplification. Similarly, using `balred` to reduce state-space models can yield more accurate results than `minreal`.

When you use a reduced-order model, always verify that the simplification or approximation preserves model characteristics that are important for your application. For example, compare the frequency responses of the original and reduced models using `bode` or `sigma`. Or, compare the open-loop responses for the original and reduced plant and controller models.

See Also

`sminreal` | `minreal` | `balred`

Related Examples

- “Approximate Model with Lower-Order Model” on page 5-37
- “Approximate Model with Unstable or Near-Unstable Pole” on page 5-47
- “Eliminate States by Pole-Zero Cancellation” on page 5-51

Approximate Model with Lower-Order Model

This example shows how to compute a reduced-order approximation of a model using `balred`.

To compute a reduced-order approximation, you first choose an order for the reduced model by examining the contribution of the various states to the overall model behavior.

Load the high-order model.

```
load ltiexamples hplant
order(hplant)
```

```
ans =
```

```
23
```

`hplant` is a 23rd-order SISO model. When choosing an order for the reduced system, it is helpful to know how many states make a significant contribution to the overall model behavior.

Examine the relative amount of energy per state using a Hankel singular value (HSV) plot.

```
hsvplot(hplant)
```

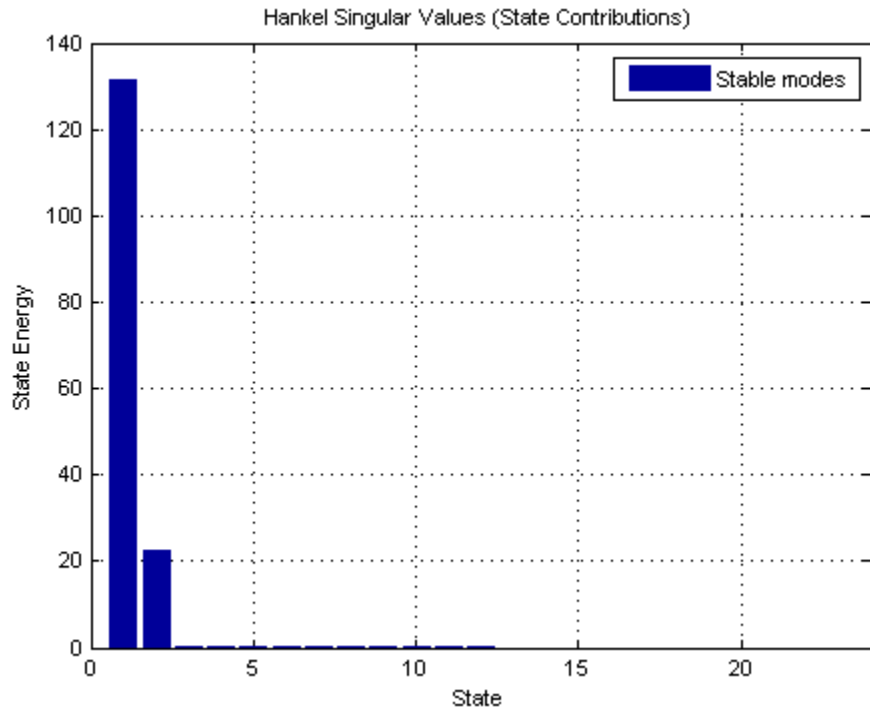

Small Hankel singular values indicate that the associated states contribute little to the behavior of the system. The plot shows that two states account for most of the energy in the system. Therefore, try simplifying the model to just first or second order.

Compute first-order and second-order reduced approximations of `hplant`.

```
opts = balredOptions('StateElimMethod','Truncate');
hplant1 = balred(hplant,1,opts);
hplant2 = balred(hplant,2,opts);
```

The second argument to `balred` specifies the target approximation order.

By default, `balred` discards the states with the smallest Hankel singular values, and alters the remaining states to preserve the DC gain of the system.

Setting the `StateElimMethod` option to `Truncate` causes `balred` to discard low-energy states without altering the remaining states.

Compare the frequency responses of the original and approximated systems.

When working with reduced-order models, it is important to verify that the approximation does not introduce inaccuracies at frequencies that are important for your application.

```
bodeplot(hplant,hplant2,hplant1)
legend('Original','2nd order','1st order')
```

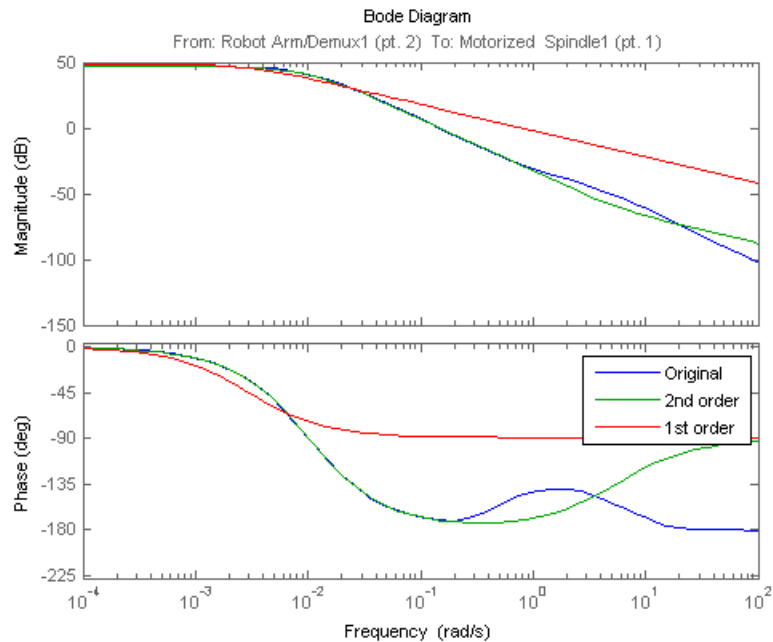

When working with MIMO systems, you can use `sigma` to examine a singular value plot rather than a Bode plot.

In this case, the second-order system matches the original 23rd-order system very well, especially at lower frequencies. The first-order system does not match as well.

In general, as you decrease the order of the approximated model, the frequency response of the approximated model begins to differ from the original model. Choose an approximation that is sufficiently accurate in the bands that are important to you. For example, in a control system, you might want good accuracy inside the control bandwidth. Accuracy at frequencies far above the control bandwidth, where the gain rapidly rolls off, might be less important.

Examine the time-domain responses of the original and reduced-order systems.

```
stepplot(hplant,hplant2,hplant1)
legend('Original','2nd order','1st order','Location','SouthEast')
```

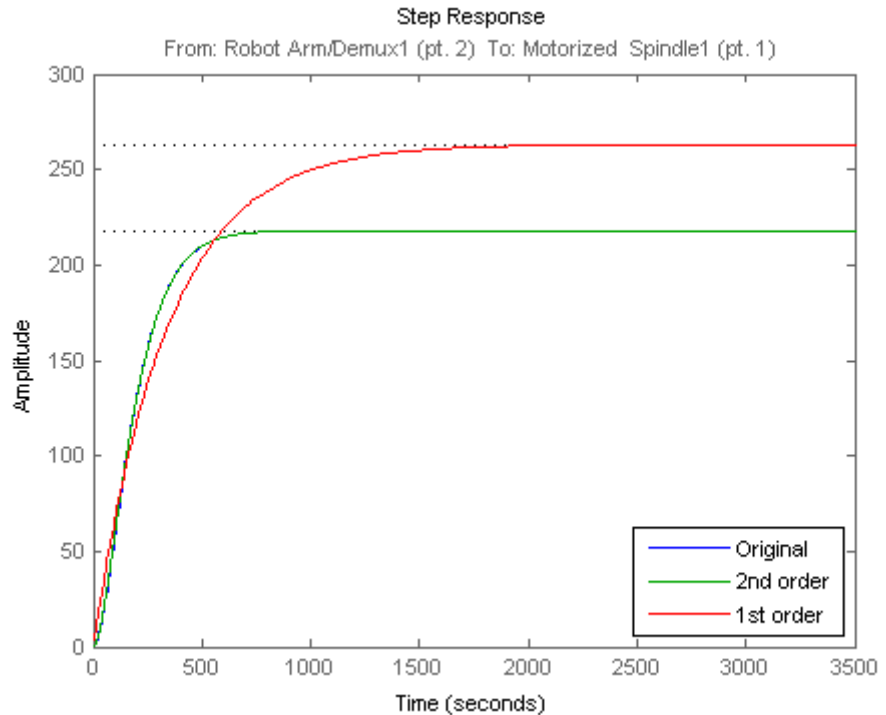

This result confirms that the second-order approximation is a good match to the original 23rd-order system.

See Also

hsvplot | balred

Related Examples

- “Approximate Model with Unstable or Near-Unstable Pole” on page 5-47
- “Choose a Low-Order Approximation Method” on page 5-42
- “Eliminate States by Pole-Zero Cancellation” on page 5-51

Concepts

- “Cancellation Versus Approximation” on page 5-35

Choose a Low-Order Approximation Method

This example compares two ways of computing a low-order approximation with `balred`: approximation with DC matching and approximation by state truncation.

By default, `balred` discards the states with that make the smallest contribution to system behavior, altering the remaining states to preserve the DC gain of the system. Setting the `StateElimMethod` option to `Truncate` causes `balred` to discard low-energy states without altering the remaining states. Which method you choose depends upon what dynamics are important to your application. In general, preserving DC gain comes at the expense of accuracy in higher-frequency dynamics. Conversely, state truncation can yield more accuracy in fast transients, at the expense of low-frequency accuracy.

In this example, compare the two methods of computing a reduced-order approximation of the following closed-loop system from r to y .

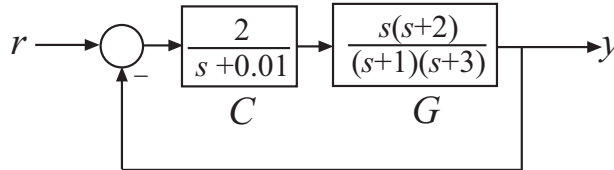

Create the closed-loop model from r to y .

```
G = zpk([0 -2],[ -1 -3],1);
C = tf(2,[1 1e-2]);
T = feedback(G*C,1)
```

T =

$$\frac{2 s (s+2)}{(s+0.004277) (s+1.588) (s+4.418)}$$

Continuous-time zero/pole/gain model.

T is a third-order system that has a near pole-zero cancellation close to $s = 0$. Therefore, it is a good candidate for order reduction by approximation.

Compute two second-order approximations to T — one that preserves the DC gain and one that truncates the lowest-energy state without changing the other states.

```
matchopt = balredOptions('StateElimMethod','MatchDC');  
truncopt = balredOptions('StateElimMethod','Truncate');  
Tmatch = balred(T,2,matchopt);  
Ttrunc = balred(T,2,truncopt);
```

Use `balredOptions` to specify the approximation method.

Compare the frequency responses of the approximated models.

```
bodeplot(T,Tmatch,Ttrunc)  
legend('Original','DC Match','Truncate')
```

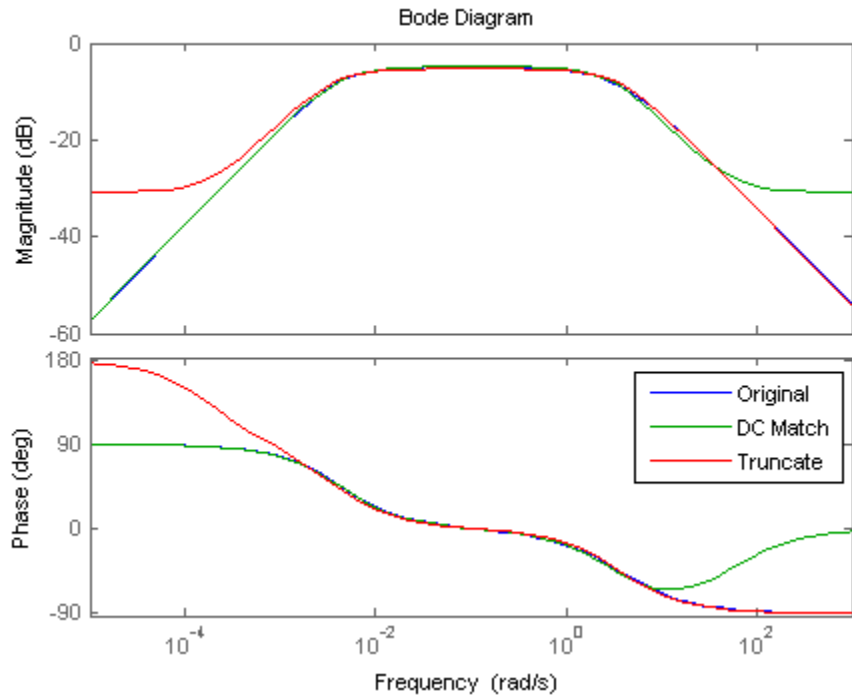

The truncated model `Ttrunc` matches the original model well at high frequencies, but differs considerably at low frequency. Conversely, `Tmatch` yields a good match at low frequencies as expected, at the expense of high frequency accuracy.

You can also see the differences between the two methods by examining the time-domain response in different regimes. Compare the slow dynamics by looking at the step response of all three models with a long time horizon.

```
stepplot(T,Tmatch,'r--',Ttrunc,1000)
legend('Original','DC Match','Truncate')
```

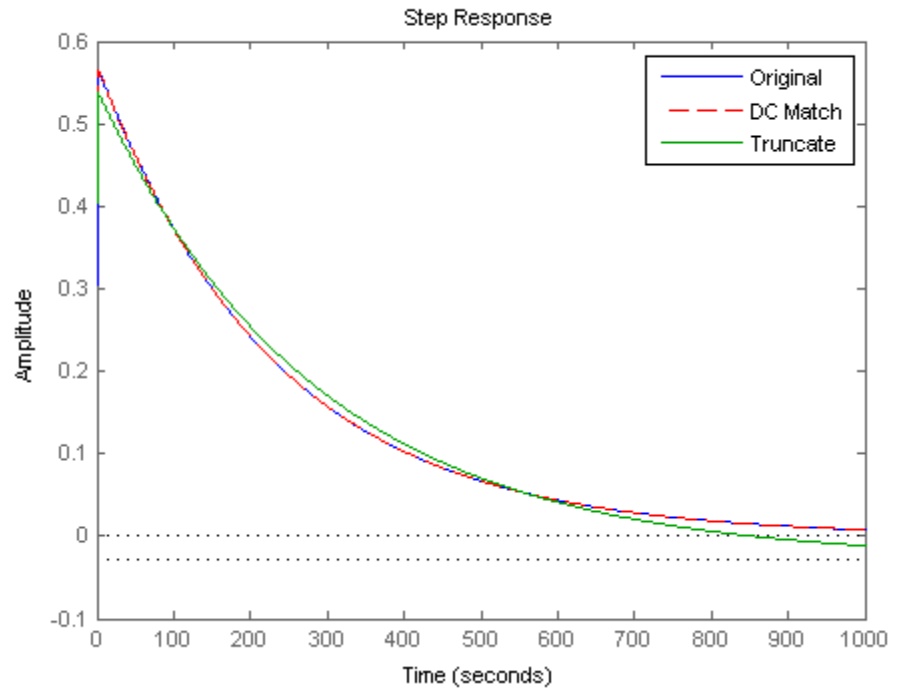

As expected, on long time scales the DC matched approximation T_{match} is a good match to the original model.

Compare the fast transients in the step response.

```
stepplot(T,Tmatch,'r',Ttrunc,'g--',1)  
legend('Original','DC Match','Truncate')
```

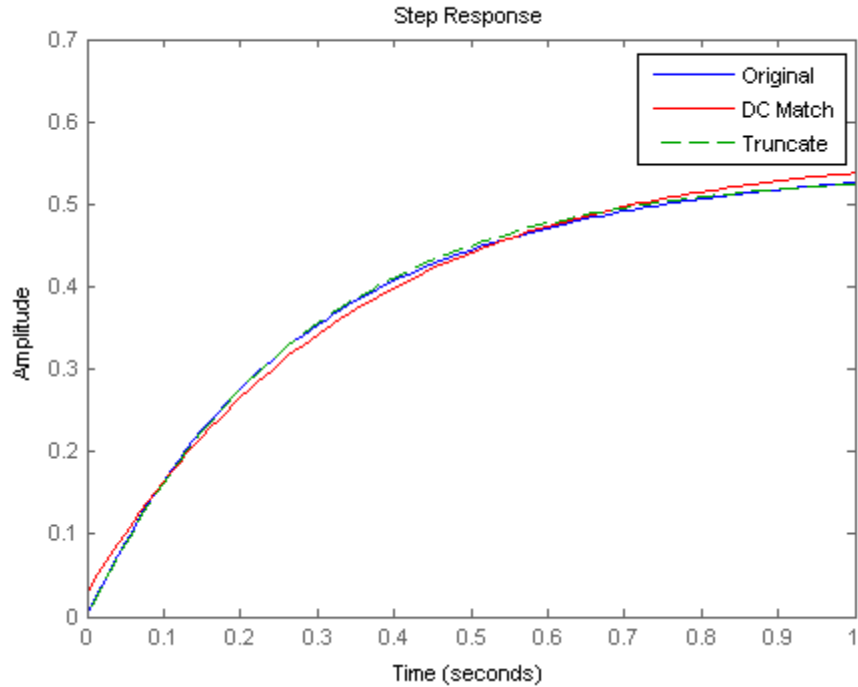

On short time scales, the truncated approximation T_{trunc} provides a better match to the original model. Which approximation method you should use depends on which regime is most important for your application.

See Also [balred](#)

Related Examples

- “Approximate Model with Lower-Order Model” on page 5-37
- “Approximate Model with Unstable or Near-Unstable Pole” on page 5-47
- “Eliminate States by Pole-Zero Cancellation” on page 5-51

Concepts

- “Cancellation Versus Approximation” on page 5-35

Approximate Model with Unstable or Near-Unstable Pole

This example shows how to compute a reduced-order approximation of a system using `balred` when the system has unstable or near-unstable poles.

`balred` does not eliminate unstable poles when computing a reduced-order approximation, because doing so would fundamentally change the system dynamics. Instead, `balred` first decomposes the model into stable and unstable parts. Then, `balred` reduces the stable part of the model.

Load a model with unstable poles.

```
load reduce.mat gasf35unst
```

`gasf35unst` is a 25-state SISO model with two unstable poles ($s > 0$).

Examine the system poles to find near-unstable poles.

```
pzplot(gasf35unst)
axis([-0.001 0.001 -0.0004 0.0004])
```

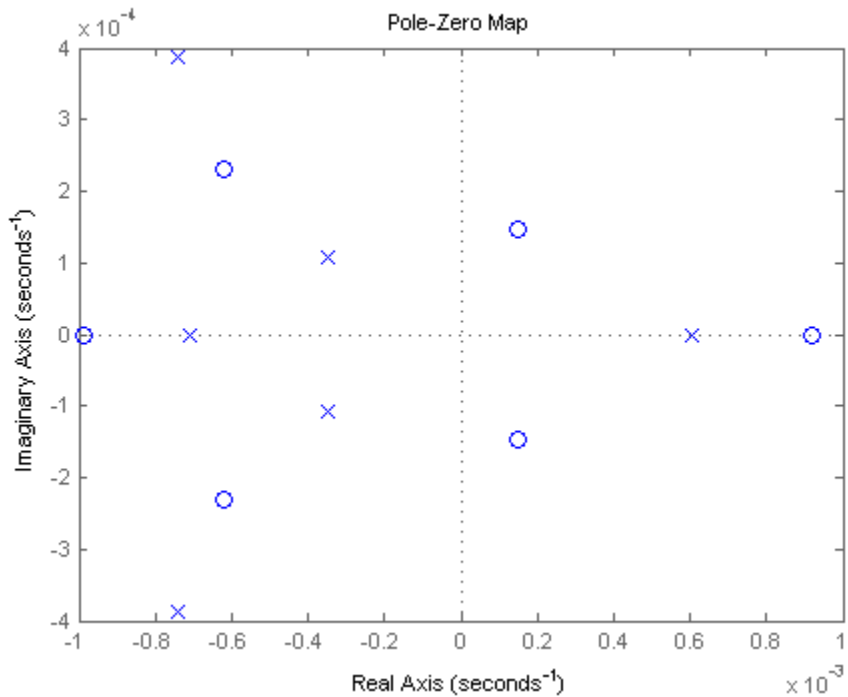

The pole-zero plot shows several poles (marked by x) that are stable, but relatively close to the imaginary axis. In your application, you might want to ensure that `balred` does not discard these near-unstable poles.

To do so, calculate a reduced-order system that preserves the two stable poles within 0.0005 s^{-1} of the imaginary axis.

```
opts = balredOptions('Offset',0.0005);
gasf_arr = balred(gasf35unst,[10 15],opts);
```

The `Offset` option of `balredOptions` sets the boundary between poles that `balred` can discard, and poles that `balred` must preserve (treat as unstable). Setting `Offset` to `0.0005` preserves the two stable poles of `gasf35unst` that are closest to the imaginary axis.

Providing `balred` an array of target approximation orders [10 15] causes `balred` to return an array of approximated models. The array `gasf_arr` contains two models — a 10th-order and a 15th-order approximation of `gasf35unst`. In both approximations, `balred` does not discard the two unstable poles or the two nearly-unstable poles.

Compare the reduced-order approximations to the original model.

```
bodeplot(gasf35unst, gasf_arr, 'r--')
```

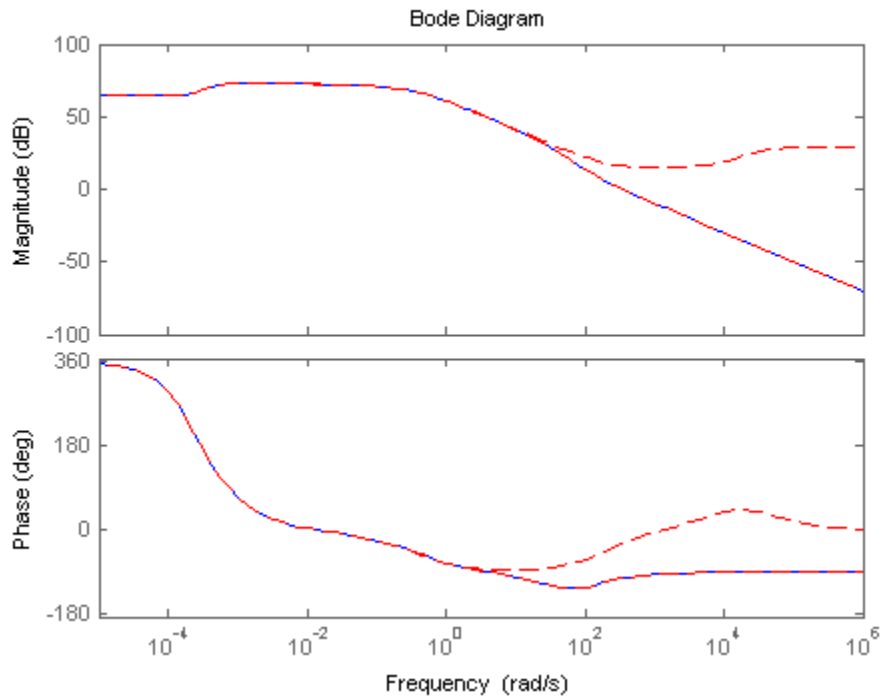

The 15th order approximation is a good frequency-domain match to the original model. However, the 10th-order approximation shows changes in high-frequency dynamics, which might be too large to be acceptable. The 15th-order approximation is probably a better choice.

See Also balred

**Related
Examples**

- “Approximate Model with Lower-Order Model” on page 5-37
- “Eliminate States by Pole-Zero Cancellation” on page 5-51

Concepts

- “Cancellation Versus Approximation” on page 5-35

Eliminate States by Pole-Zero Cancellation

This example shows how to use to reduce the order of a transfer function with cancelling or near-cancelling factors in the numerator and denominator using `minreal`.

Cancelling or near-cancelling pole-zero pairs can arise from system dynamics, or from building models using model interconnection functions.

Create a model of the following system, where `C` is a PI controller and `G` has a zero at 3×10^{-8} rad/s. Such a low-frequency zero can arise from derivative action somewhere in the plant dynamics. For example, the plant may include a component that computes speed from position measurements.

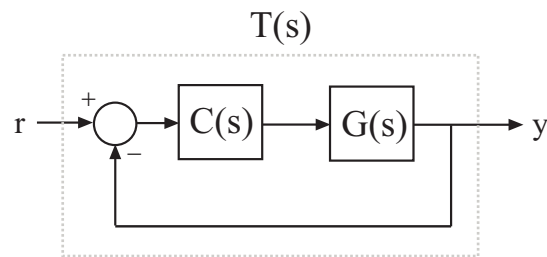

```
G = zpk(3e-8, [-1, -3], 1);
C = pid(1, 0.3);
T = feedback(G*C, 1)
```

`T =`

$$\frac{(s+0.3)(s+3e-08)}{s(s+4.218)(s+0.7824)}$$

Continuous-time zero/pole/gain model.

In the closed-loop model `T`, the integrator ($1/s$) from `C` very nearly cancels the low-frequency zero of `G`.

Force a cancellation of the integrator with the zero near the origin.

```
Tred = minreal(T,1e-7)
```

```
Tred =
```

$$\frac{(s+0.3)}{(s+4.218)(s+0.7824)}$$

Continuous-time zero/pole/gain model.

By default, `minreal` reduces transfer function order by canceling exact pole-zero pairs or near pole-zero pairs within `sqrt(eps)`. Specifying `1e-7` as the second input causes `minreal` to eliminate pole-zero pairs within 10^{-7} rad/s of each other.

The reduced model `Tred` includes all the dynamics of the original closed-loop model `T`, except for the near-canceling zero-pole pair.

Compare the frequency responses of the original and reduced systems.

```
bode(T,Tred,'r--')  
legend('T','Tred')
```

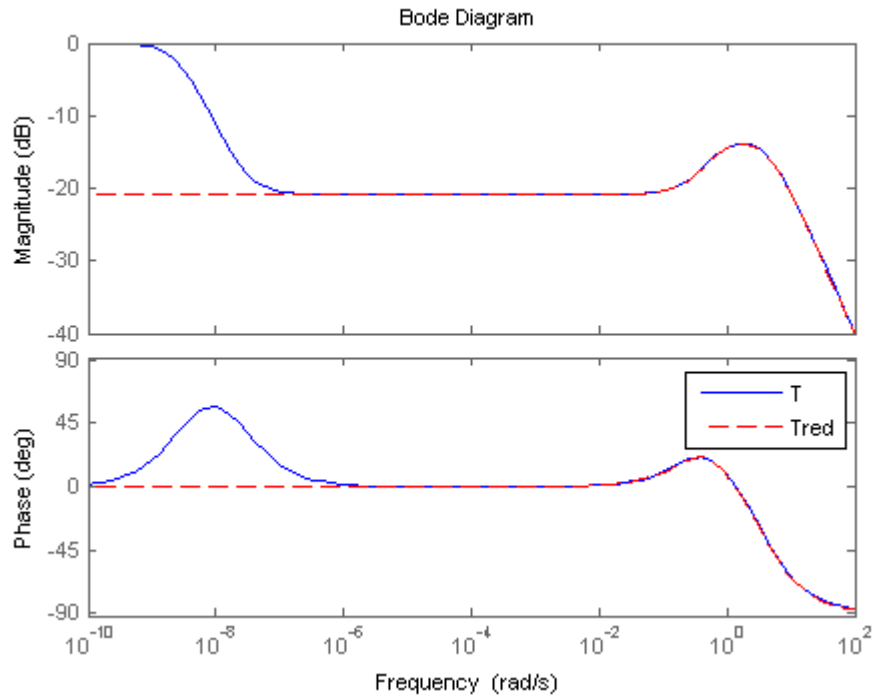

Because the canceled pole and zero do exactly match, some extreme low-frequency dynamics evident in the original model are missing from `Tred`. In many applications, you can neglect such extreme low-frequency dynamics. When you increase the matching tolerance of `minreal`, make sure that you do not eliminate dynamic features that are relevant to your application.

See Also `minreal`

Related Examples

- “Approximate Model with Lower-Order Model” on page 5-37
- “Approximate Model with Unstable or Near-Unstable Pole” on page 5-47
- “Choose a Low-Order Approximation Method” on page 5-42

Concepts

- “Cancellation Versus Approximation” on page 5-35

Linear Analysis

- Chapter 6, “Time Domain Analysis”
- Chapter 7, “Frequency Domain Analysis”
- Chapter 8, “Sensitivity Analysis”

Time Domain Analysis

- “Choosing a Time-Domain Analysis Command” on page 6-2
- “Time-Domain Response Data and Plots” on page 6-3
- “System Characteristics on Response Plots” on page 6-6
- “Numeric Values of Time-Domain System Characteristics” on page 6-10
- “Time-Domain Responses of Discrete-Time Model” on page 6-12
- “Time-Domain Responses of MIMO Model” on page 6-15
- “Time-Domain Responses of Multiple Models” on page 6-17
- “Joint Time- and Frequency-Domain Analysis” on page 6-20
- “Response from Initial Conditions” on page 6-26
- “Analysis of Systems with Time Delays” on page 6-29

Choosing a Time-Domain Analysis Command

When you perform time-domain analysis of a dynamic system model, you may want one or more of the following:

- A plot of the system response as a function of time.
- Numerical values of the system response in a data array.
- Numerical values of characteristics of the system response such as peak response or settling time.

Control System Toolbox time-domain analysis commands can obtain these results for any kind of dynamic system model (for example, continuous or discrete, SISO or MIMO, or arrays of models) except for frequency response data models.

To obtain numerical data, use:

- `step`, `impulse`, `initial`, `lsim` — System response data at a vector of time points.
- `stepinfo`, `lsiminfo` — Numerical values of system response characteristics such as settling time and overshoot.

To obtain response plots, use:

- `stepplot`, `impulseplot`, `initialplot`, `lsimplot` — Plot system response data, visualize response characteristics on plots, compare responses of multiple systems on a single plot.
- `ltiview` — Linear analysis tool for plotting many types of system responses simultaneously, including both time-domain and frequency-domain responses

Time-Domain Response Data and Plots

This example shows how to obtain step and impulse response data, as well as step and impulse response plots, from a dynamic system model.

Create a transfer function model and plot its response to a step input at $t = 0$.

```
H = tf([8 18 32],[1 6 14 24]);  
stepplot(H);
```

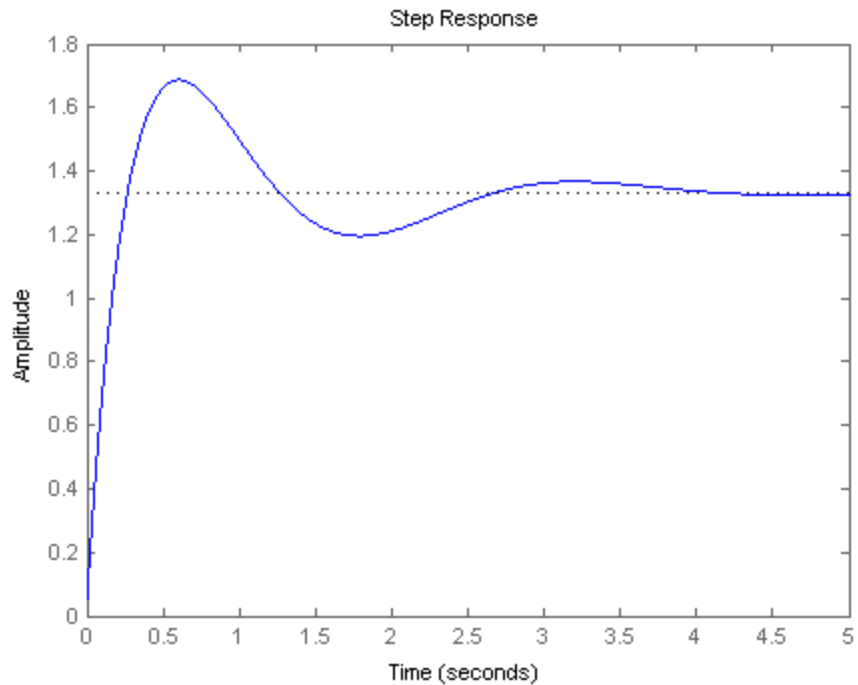

`stepplot` plots the step response on the screen. Unless you specify a time range to plot, `stepplot` automatically chooses a time range that illustrates the system dynamics.

Calculate the step response data from $t = 0$ (application of the step input) to $t = 8$ s.

```
[y,t] = step(H,8);
```

When you call `step` with output arguments, the command returns the step response data `y`. The vector `t` contains corresponding time values.

Plot the response of `H` to an impulse input applied at $t = 0$. Plot the response with a grid.

```
opts = timeoptions;  
opts.Grid = 'on';  
impzplot(H,opts)
```

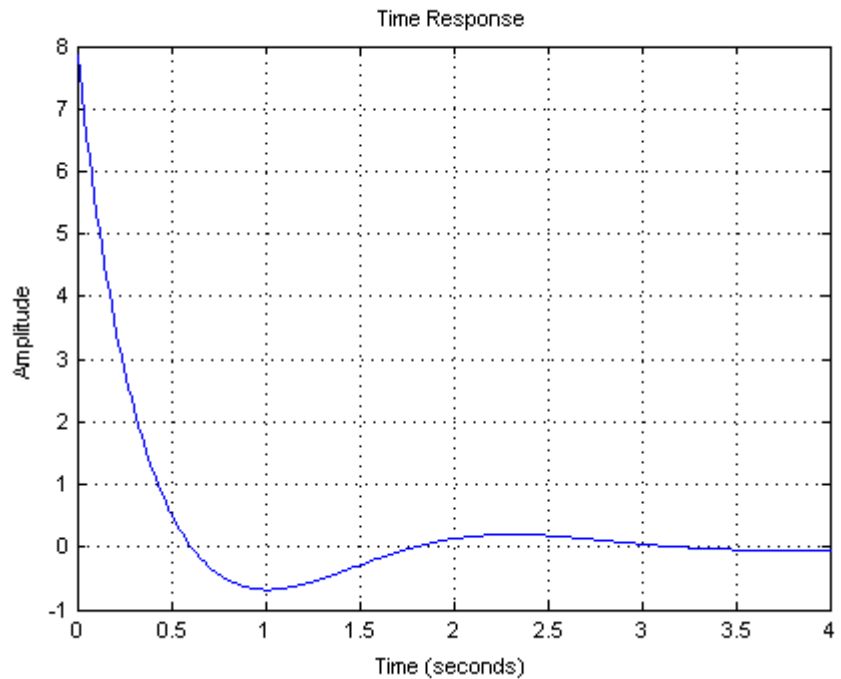

Use the `timeoptions` command to define options sets for time-domain plotting commands like `impzplot` and `stepplot`.

Calculate 200 points of impulse response data from $t = 1$ (one second after application of the impulse input) to $t = 3$ s.

```
[y,t] = impulse(H,linspace(1,3,200));
```

As for `step`, you can omit the time vector to allow `impz` to automatically select a time range.

See Also

`step` | `impz` | `stepplot` | `impzplot` | `timeoptions`

Related Examples

- “System Characteristics on Response Plots” on page 6-6
- “Time-Domain Responses of Discrete-Time Model” on page 6-12
- “Time-Domain Responses of MIMO Model” on page 6-15
- “Time-Domain Responses of Multiple Models” on page 6-17

Concepts

- “Choosing a Time-Domain Analysis Command” on page 6-2

System Characteristics on Response Plots

This example shows how to display system characteristics such as settling time and overshoot on step response plots.

You can use similar procedures to display system characteristics on impulse response plots or initial value response plots, such as peak response or settling time.

Create a transfer function model and plot its response to a step input at $t = 0$.

```
H = tf([8 18 32],[1 6 14 24]);  
stepplot(H)
```

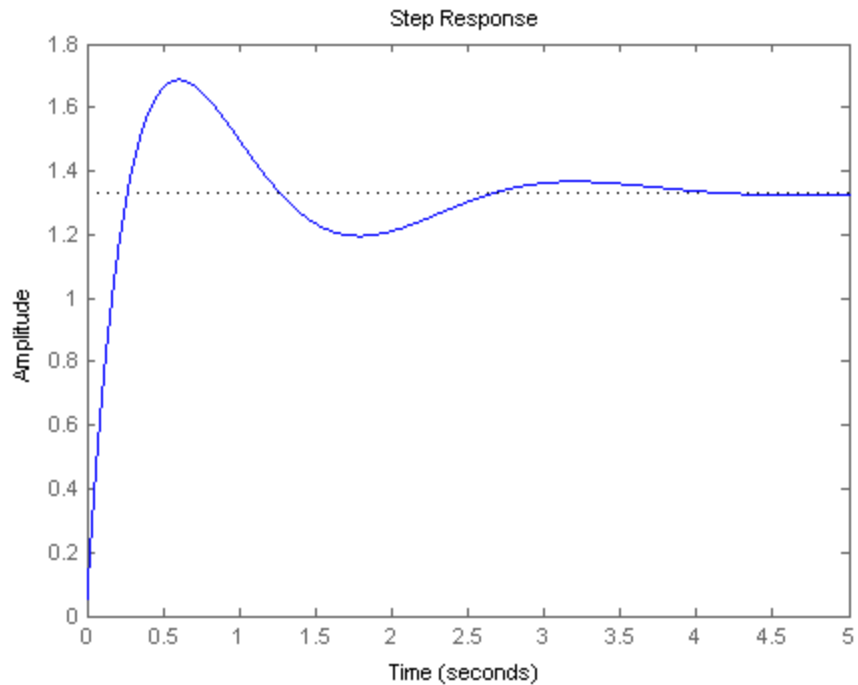

Display the peak response on the plot.

Right-click anywhere in the figure and select **Characteristics > Peak Response** from the menu.

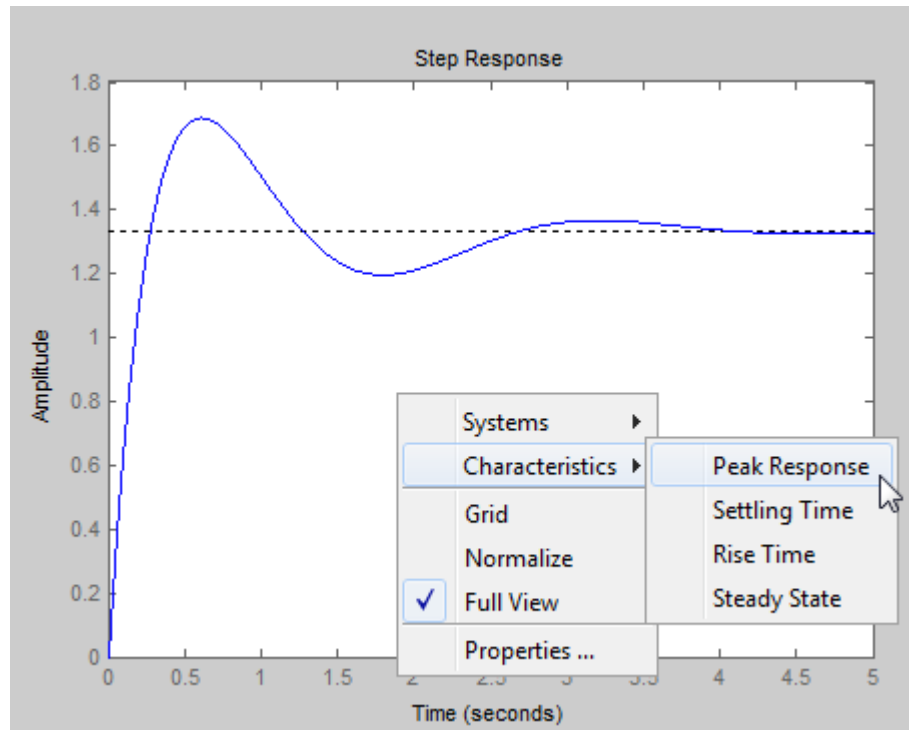

A marker appears on the plot indicating the peak response. Horizontal and vertical dotted lines indicate the time and amplitude of that response.

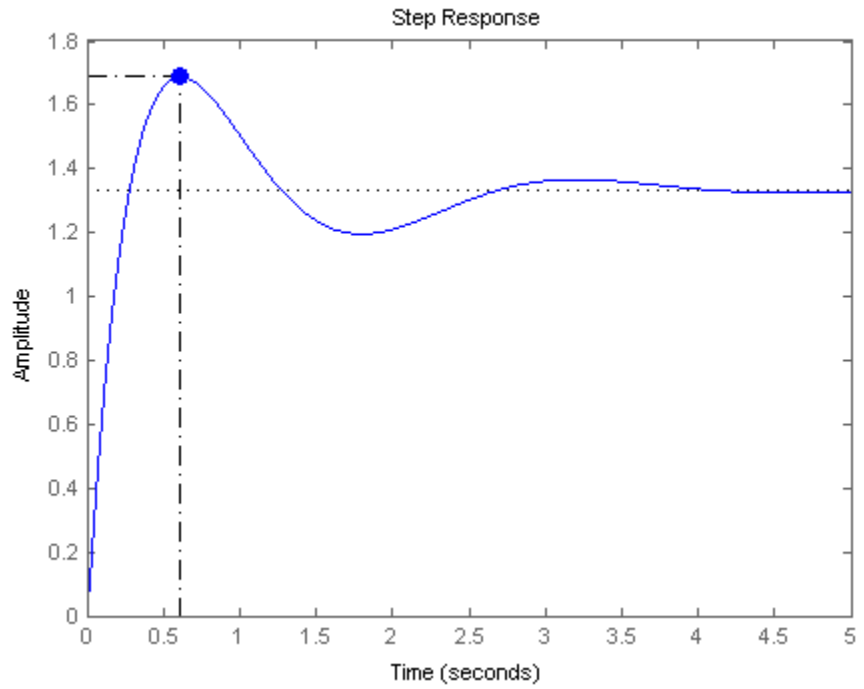

Click the marker to view the value of the peak response and the overshoot in a datatip.

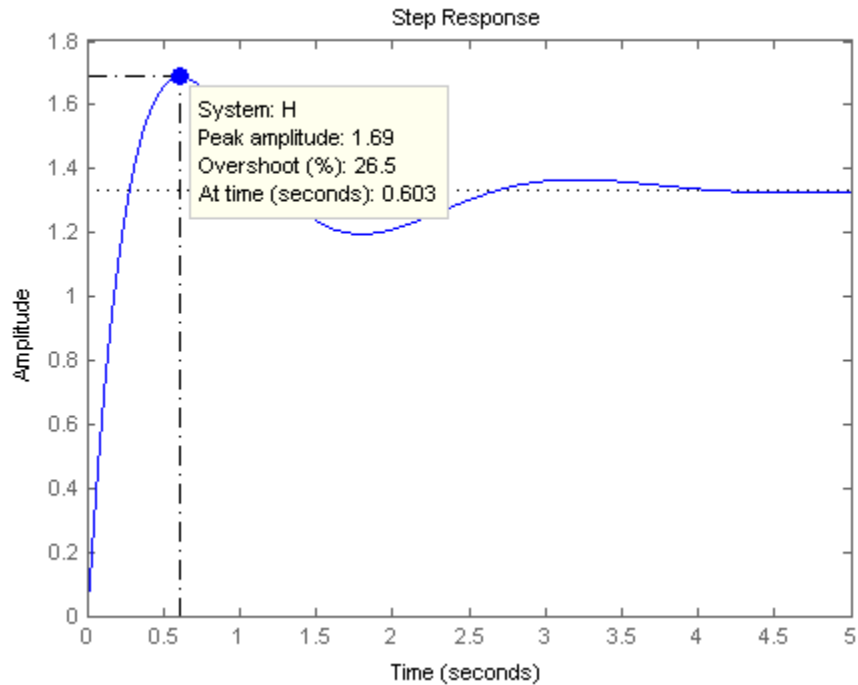

You can use a similar procedure to select other characteristics such as settling time and rise time from the **Characteristics** menu and view the values.

See Also

`step` | `impulse` | `stepinfo` | `lsiminfo`

Related Examples

- “Numeric Values of Time-Domain System Characteristics” on page 6-10

Concepts

- “Choosing a Time-Domain Analysis Command” on page 6-2

Numeric Values of Time-Domain System Characteristics

This example shows how to obtain numeric values of step response characteristics such as rise time, settling time, and overshoot using `stepinfo`.

You can use similar techniques with `lsiminfo` to obtain characteristics of the system response to an arbitrary input or initial conditions.

Create a dynamic system model and get numeric values of the system's step response characteristics.

```
H = tf([8 18 32],[1 6 14 24]);  
data = stepinfo(H)
```

```
data =  
  
    RiseTime: 0.2087  
    SettlingTime: 3.4972  
    SettlingMin: 1.1956  
    SettlingMax: 1.6872  
    Overshoot: 26.5401  
    Undershoot: 0  
    Peak: 1.6872  
    PeakTime: 0.6033
```

The output is a structure that contains values for several step response characteristics. To access these values or refer to them in other calculations, use dot notation. For example, `data.Overshoot` is the overshoot value.

Calculate the time it takes the step response of `H` to settle within 0.5% of its final value.

```
data = stepinfo(H, 'SettlingTimeThreshold', 0.005);  
t05 = data.SettlingTime
```

```
t05 =  
  
    4.8897
```

By default, `stepinfo` defines the settling time as the time it takes for the output to settle within 0.02 (2%) of its final value. Specifying a more stringent 'SettlingTimeThreshold' of 0.005 results in a longer settling time.

For more information about the options and the characteristics, see the `stepinfo` reference page.

See Also

`stepinfo` | `lsiminfo`

Related Examples

- “System Characteristics on Response Plots” on page 6-6

Concepts

- “Choosing a Time-Domain Analysis Command” on page 6-2

Time-Domain Responses of Discrete-Time Model

This example shows how to obtain a step response and step response data for a discrete-time dynamic system model.

You can use the techniques of this example with commands such as `impulse`, `initial`, `impzplot`, and `initialpot` to obtain time-domain responses of discrete-time models. Obtaining time-domain responses of discrete-time models is the same as for continuous-time models, except that the time sample points are limited by the sampling time T_s of the model.

Create a discrete-time transfer function model and plot its response to a step input at $t = 0$.

```
H = tf([-0.06,0.4],[1,-1.6,0.78],0.1);  
stepplot(H)
```

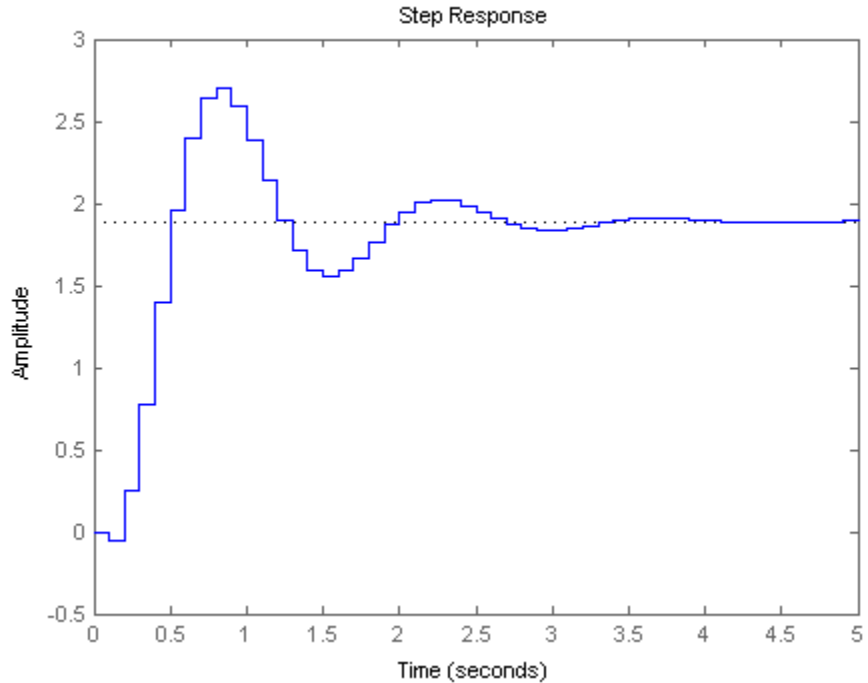

For discrete-time models, `stepplot` plots the response at multiples of the sampling period, assuming a hold between samples.

Compute the step response of `H` between 0.5 and 2.5 seconds.

```
[y,t] = step(H,0.5:0.1:2.5);
```

When you specify a time vector for the response of a discrete-time model, the time step must match the sampling time T_s of the discrete-time model. The vector `t` contains the time points between 0.5 and 2.5 seconds, at multiples of the sampling time of `H`, 0.1 s. The vector `y` contains the corresponding step response values.

See Also

`step` | `impulse` | `stepplot` | `initial` | `impzplot` | `initialplot`

Related Examples

- “System Characteristics on Response Plots” on page 6-6
- “Time-Domain Responses of Discrete-Time Model” on page 6-12
- “Time-Domain Responses of MIMO Model” on page 6-15
- “Time-Domain Responses of Multiple Models” on page 6-17

Concepts

- “Choosing a Time-Domain Analysis Command” on page 6-2

Time-Domain Responses of MIMO Model

This example shows how to obtain impulse response data and plots for a multi-input, multi-output (MIMO) model using `impulse`.

You can use the same techniques to obtain other types of time-domain responses of MIMO models.

Create a MIMO model and plot its response to a $t = 0$ impulse at all inputs.

```
H = rss(2,2,2);
H.InputName = 'Control';
H.OutputName = 'Temperature';
impzplot(H)
```

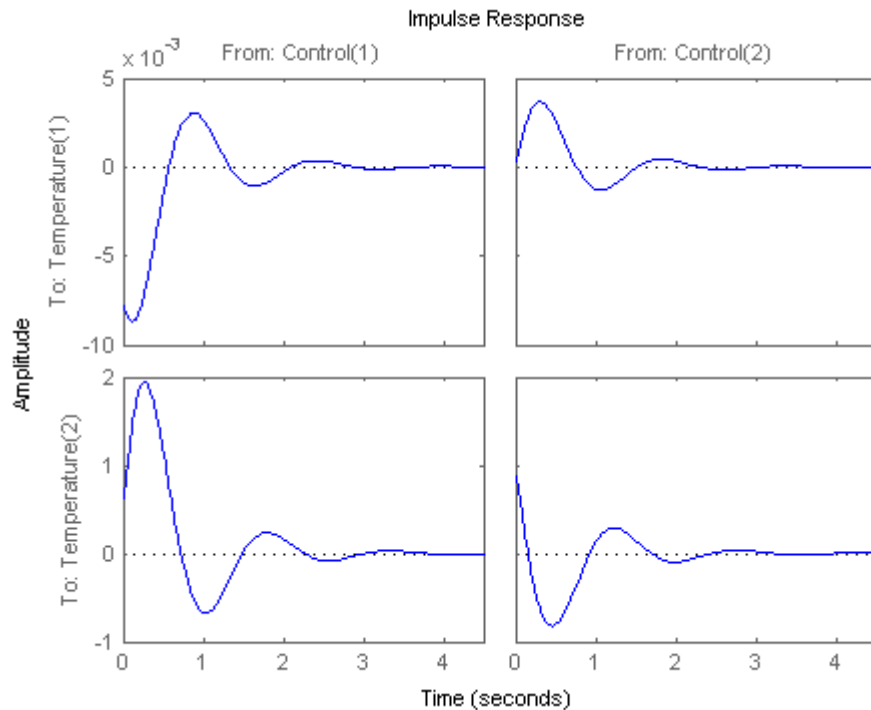

`impzplot` plots the response of each output to an impulse applied at each input. (Because `rss` generates a random state-space model, you might see different responses from those pictured.) The first column of plots shows the response of each output to an impulse applied at the first input, `Control(1)`. The second column shows the response of each output to an impulse applied at the second input, `Control(2)`.

Calculate the impulse responses of all channels of `H`, and examine the size of the output.

```
[y,t] = impulse(H);  
size(y)
```

```
ans =
```

```
334    2    2
```

The first dimension of the data array `y` is the number of samples in the time vector `t`. The `impz` command determines this number automatically if you do not supply a time vector. The remaining dimensions of `y` are the numbers of outputs and inputs in `H`. Thus, `y(:,i,j)` is the response at the `i`th output of `H` to an impulse applied at the `j`th input.

See Also

`step` | `initial` | `stepplot` | `initialplot` | `impz` | `impzplot`

Related Examples

- “Time-Domain Response Data and Plots” on page 6-3
- “System Characteristics on Response Plots” on page 6-6
- “Time-Domain Responses of Discrete-Time Model” on page 6-12
- “Time-Domain Responses of Multiple Models” on page 6-17

Concepts

- “Choosing a Time-Domain Analysis Command” on page 6-2

Time-Domain Responses of Multiple Models

This example shows how to compare the step responses of multiple models on a single plot using `step`. This example compares the step response of an uncontrolled plant to the closed-loop step response of the plant with two different PI controllers.

You can use similar techniques with other response commands, such as `impulse` or `initial`, to obtain plots of responses of multiple models.

Obtain two models whose time responses you want to compare, and plot them on a single step plot.

For example, you can compare a third-order plant `G`, and the closed-loop response of `G` with a controller `C1` having integral action.

```
G = zpk([], [-5 -5 -10], 100);
```

```
C1 = pid(0, 4.4);
```

```
CL1 = feedback(G*C1, 1);
```

```
step(G, CL1);
```

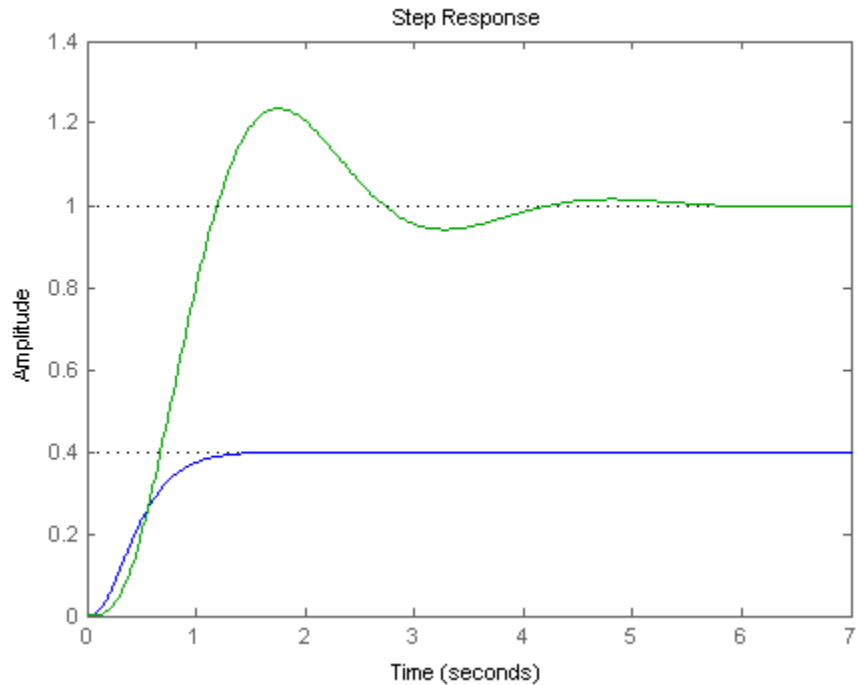

When you provide multiple models to `step` as input arguments, the command displays the responses of both models on the same plot. If you do not specify a time range to plot, `step` attempts to choose a time range that illustrates the dynamics of all the models.

Compare the step response of the closed-loop model with another controller. Specify plot colors and styles for each response.

```
C2 = pid(2.9,7.1);  
CL2 = feedback(G*C2,1);  
  
step(G, 'b--', CL1, 'g-', CL2, 'r-')
```

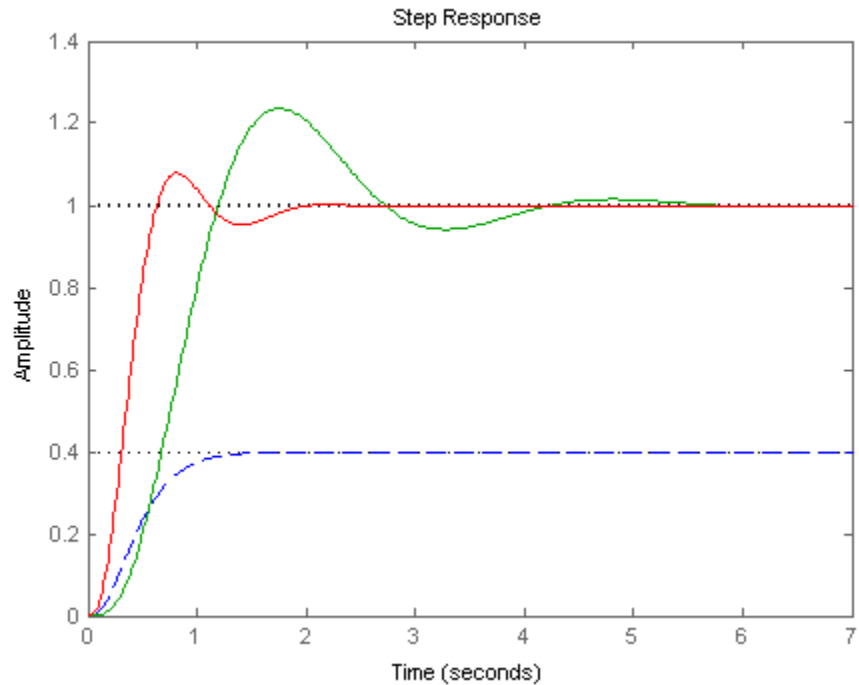
You can use formatting strings to specify plot color and style for each response in the plot. For example, 'g-' specifies a solid green line for response CL2. For additional plot customization options, use `stepplot`.

See Also

`step` | `initial` | `stepplot` | `initialplot` | `impulse` | `impulseplot` | `ltiview`

Related Examples

- “Joint Time- and Frequency-Domain Analysis” on page 6-20

Concepts

- “Choosing a Time-Domain Analysis Command” on page 6-2

Joint Time- and Frequency-Domain Analysis

This example shows how to compare multiple types of responses side by side, including both time-domain and frequency-domain responses, using the interactive LTI Viewer tool.

Obtain models whose responses you want to compare.

For example, compare a third-order plant G , and the closed-loop responses of G with two different controllers, $C1$ and $C2$.

```
G = zpk([], [-5 -5 -10], 100);  
C1 = pid(0, 4.4);  
T1 = feedback(G*C1, 1);  
C2 = pid(2.9, 7.1);  
T2 = feedback(G*C2, 1);
```

Open the LTI Viewer tool to examine the responses of the plant and the closed-loop systems.

```
ltiview(G, T1, T2)
```

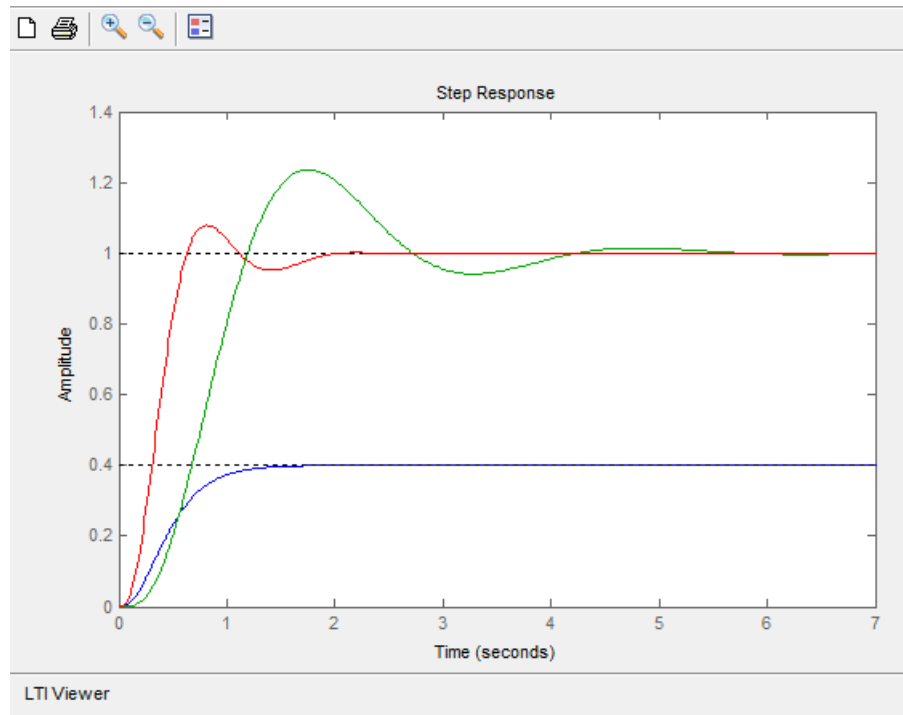

By default, the LTI Viewer launches with a plot of the step response of the three systems. Click  to add a legend to the plot.

Add plots of the impulse responses to the LTI Viewer display.

In the LTI Viewer, select **Edit > Plot Configurations** to open the Plot Configurations dialog box.

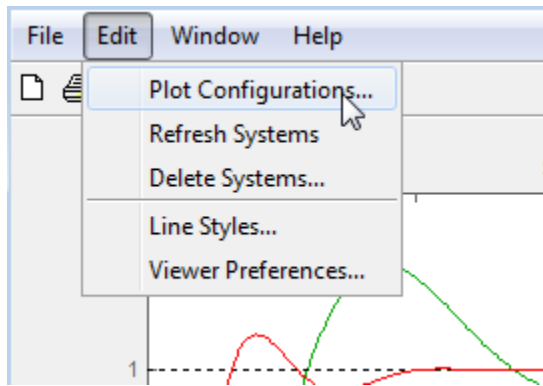

Select the two-plot configuration. In the Response Type area, select Bode Magnitude for the second plot type.

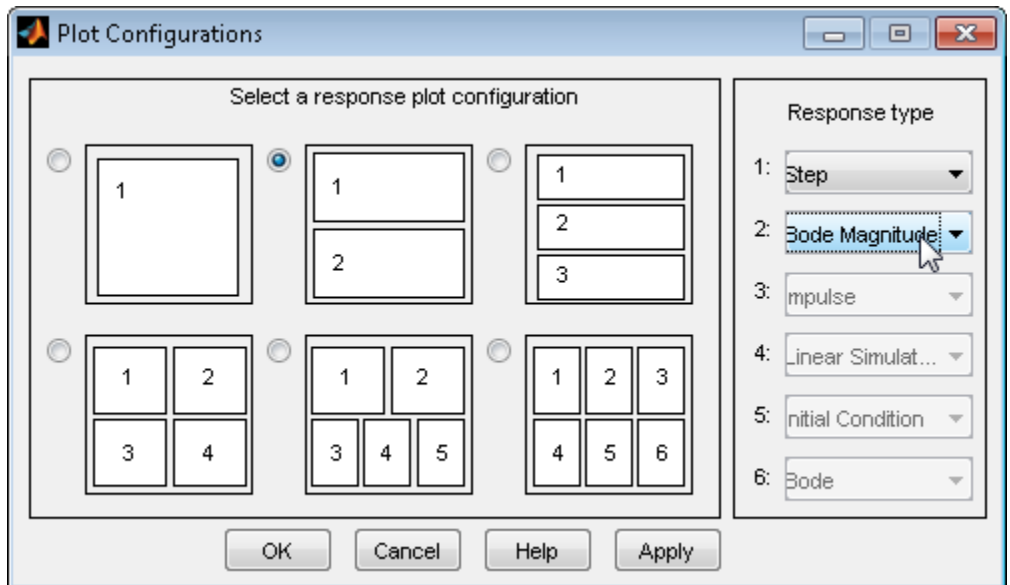

Click **OK** to add the Bode plots to the LTI Viewer display.

Display the peak values of the Bode responses on the plot.

Right-click anywhere in the Bode Magnitude plot and select **Characteristics > Peak Response** from the menu.

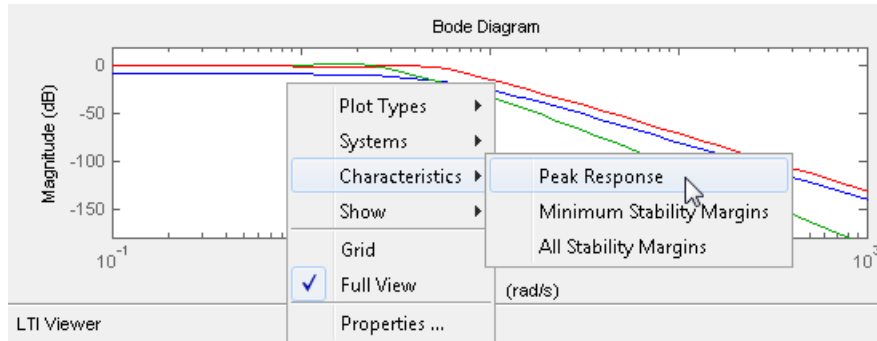

Markers appear on the plot indicating the peak response values. Horizontal and vertical dotted lines indicate the frequency and amplitude of those responses.

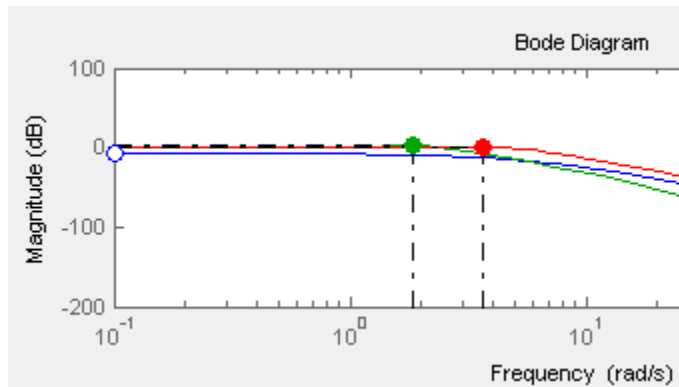

Click on a marker to view the value of the peak response in a datatip.

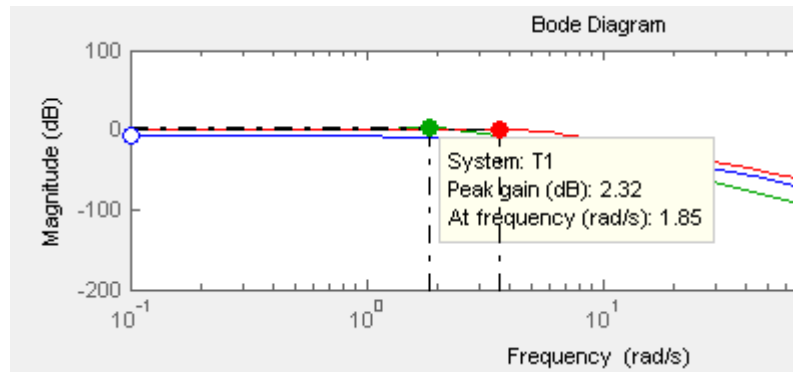

You can use a similar procedure to select other characteristics such as settling time and rise time from the **Characteristics** menu and view the values.

You can also change the type of plot displayed in the LTI Viewer. For example, change the first plot type to a plot of the impulse response.

To select a different plot type for a plot displayed in the LTI Viewer, right-click anywhere in the plot. Select **Plot Types > Impulse**

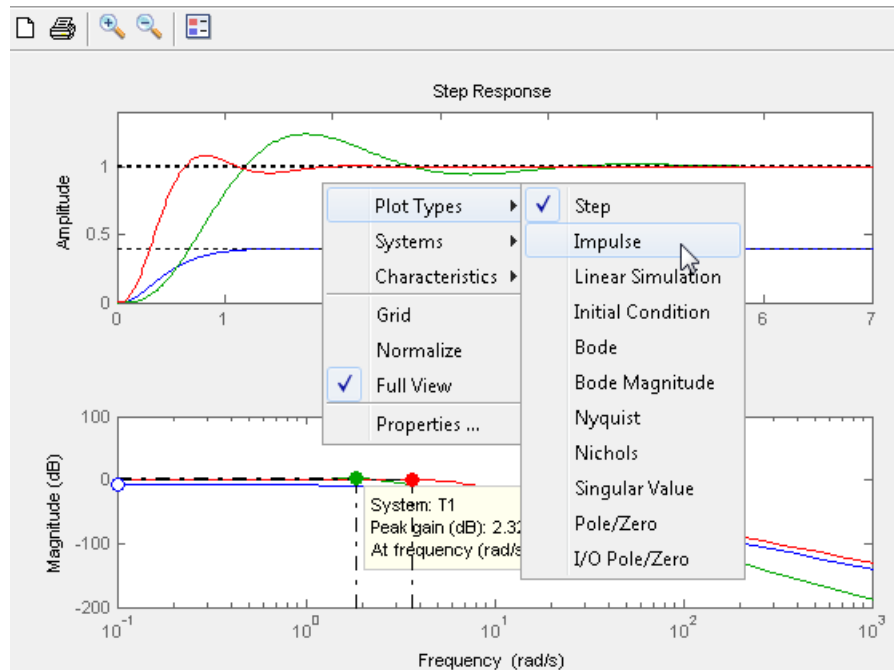

The displayed plot changes to show the impulse of the three systems.

See Also

`step` | `initial` | `stepplot` | `initialplot` | `impulse` | `impulseplot` | `ltiview`

Related Examples

- “Time-Domain Responses of Multiple Models” on page 6-17

Concepts

- “Choosing a Time-Domain Analysis Command” on page 6-2

Response from Initial Conditions

This example shows how to compute and plot the response of a state-space (ss) model to specified initial state values using `initialplot` and `initial`.

Load a state-space model.

```
load ltiexamples sys_dc
sys_dc.InputName = 'Volts';
sys_dc.OutputName = 'w';
sys_dc.StateName = {'Current', 'w'};
sys_dc
```

```
sys_dc =
```

```
a =
           Current      w
Current      -4      -0.03
w           0.75      -10
```

```
b =
           Volts
Current      2
w           0
```

```
c =
           Current      w
w           0           1
```

```
d =
           Volts
w           0
```

Continuous-time state-space model.

This example uses the SISO, 2-state model `sys_dc`. This model represents a DC motor. The input is an applied voltage, and the output is the angular rate of the motor ω . The states of the model are the induced current i (x_1), and ω (x_2).

Plot the undriven evolution of the motor's angular rate from an initial state in which the induced current is 1.0 amp and the initial rotation rate is 5.0 rad/s.

```
x0 = [1.0 5.0];  
initialplot(sys_dc,x0)
```

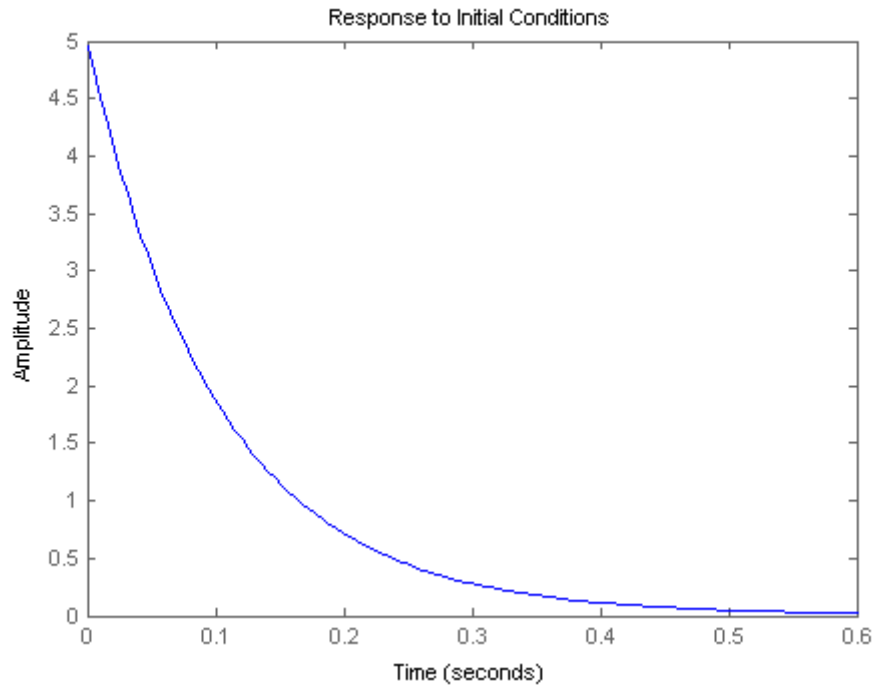

`initialplot` plots the time evolution from the specified initial condition on the screen. Unless you specify a time range to plot, `impulse` automatically chooses a time range that illustrates the system dynamics.

Calculate the time evolution of the output and the states of `sys_dc` from $t = 0$ (application of the step input) to $t = 1$ s.

```
t = 0:0.01:1;  
[y,t,x] = initial(sys_dc,x0,t);
```

The vector `y` contains the output at each time step in `t`. The array `x` contains the state values at each time step. Therefore, in this example `x` is a 2-by-101 array. Each row of `x` contains the values of the two states of `sys_dc` at the corresponding time step.

See Also

`step` | `impulse` | `initial` | `initialplot`

Related Examples

- “Time-Domain Response Data and Plots” on page 6-3
- “Numeric Values of Time-Domain System Characteristics” on page 6-10

Concepts

- “Choosing a Time-Domain Analysis Command” on page 6-2

Analysis of Systems with Time Delays

You can use the usual analysis commands (`step`, `bode`, `margin`, ...) to analyze systems with time delays. The software makes no approximations when performing such analysis.

For example, consider the following control loop, where the plant is modeled as first-order plus dead time:

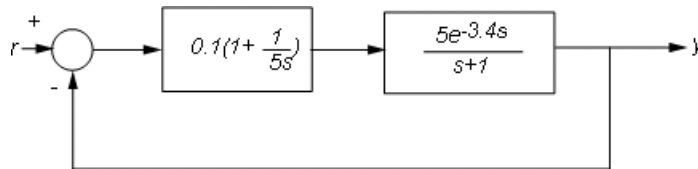

You can model the closed-loop system from r to y with the following commands:

```
s = tf('s');
P = ss(5*exp(-3.4*s)/(s+1));
C = 0.1 * (1 + 1/(5*s));
T = feedback(P*C,1)
```

T is a state-space model with an internal delay. For more information about models with internal delays, see “Closing Feedback Loops with Time Delays” on page 2-26.

Plot the step response of T :

```
step(T)
grid, title('Closed-loop step response')
```

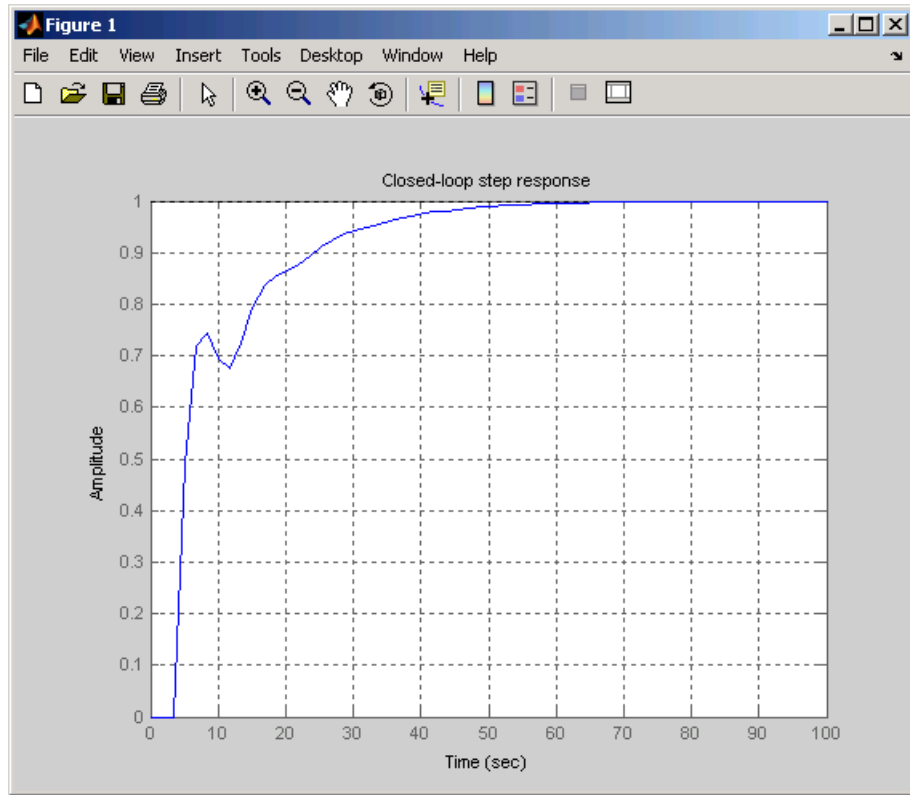

For more complicated interconnections, you can name the input and output signals of each block and use connect to automatically take care of the wiring. Suppose, for example, that you want to add feedforward to the control loop of the previous model.

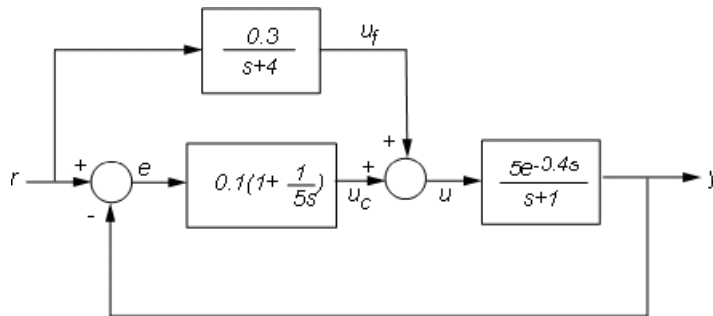

You can derive the corresponding closed-loop model Tff by

```
F = 0.3/(s+4);
P.InputName = 'u'; P.OutputName = 'y';
C.InputName = 'e'; C.OutputName = 'uc';
F.InputName = 'r'; F.OutputName = 'uf';
Sum1 = sumblk('e','r','y','+-'); % e = r-y
Sum2 = sumblk('u','uf','uc','+++'); % u = uf+uc
Tff = connect(P,C,F,Sum1,Sum2,'r','y');
```

and compare its response with the feedback only design.

```
step(T,'b',Tff,'r')
legend('No feedforward','Feedforward')
grid
title('Closed-loop step response with and without feedforward')
```

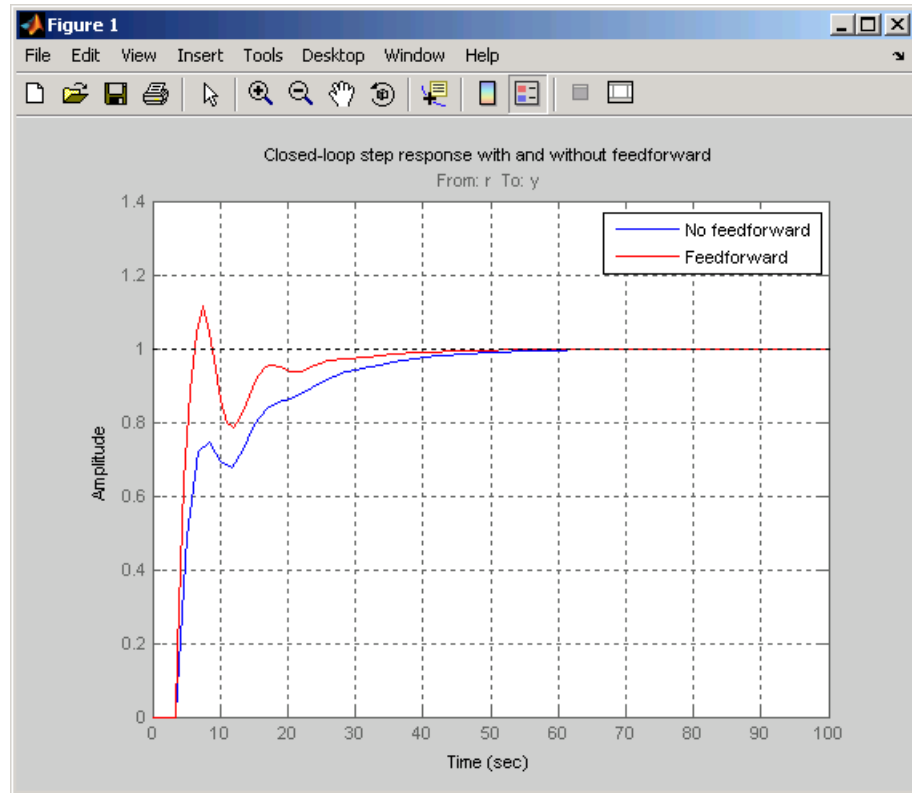

The state-space representation keeps track of the internal delays in both models.

Considerations to Keep in Mind when Analyzing Systems with Internal Time Delays

The time and frequency responses of delay systems can look odd and suspicious to those only familiar with delay-free LTI analysis. Time responses can behave chaotically, Bode plots can exhibit gain oscillations, etc. These are not software or numerical quirks but real features of such systems. Below are a few illustrations of these phenomena.

Gain ripple:

```
s=tf('s');  
G = exp(-5*s)/(s+1);  
T = feedback(ss(G),.5);  
bodemag(T)
```

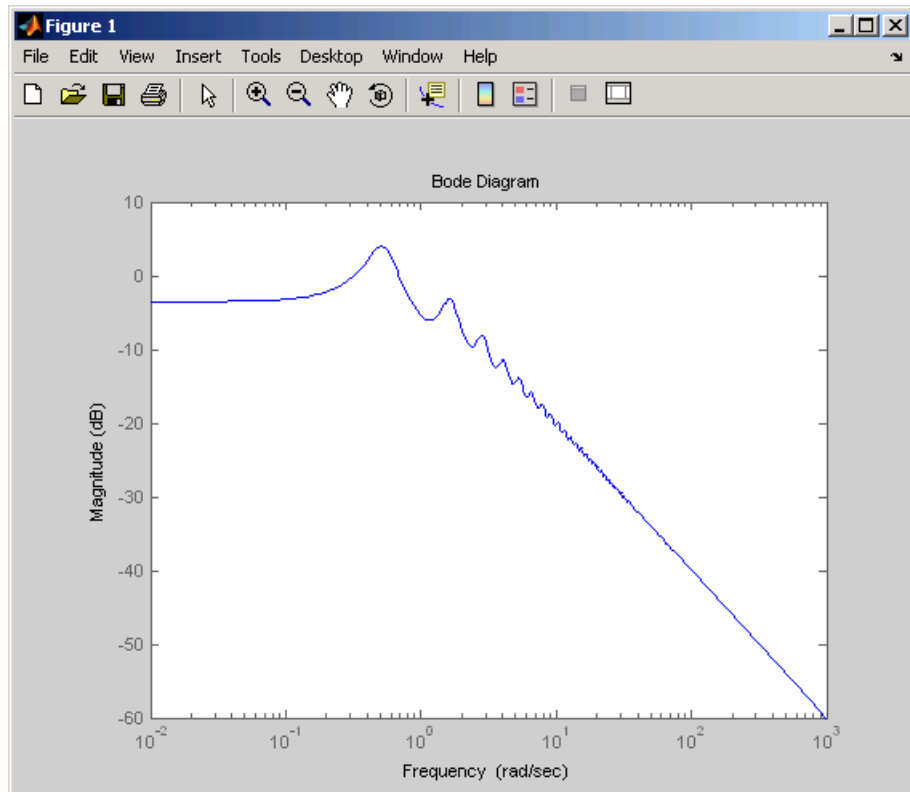

Gain oscillations:

```
G = ss(1) + 0.5 * exp(-3*s);  
bodemag(G)
```

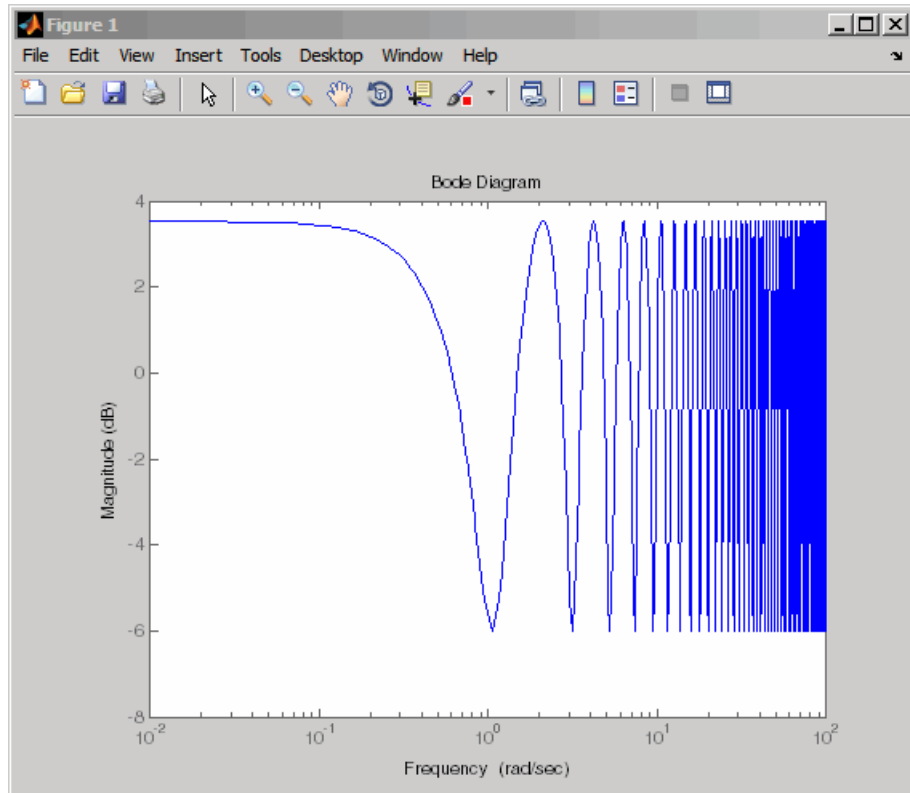

Jagged step response:

```
G = exp(-s) * (0.8*s^2+s+2)/(s^2+s);  
T = feedback(ss(G),1);  
step(T)
```

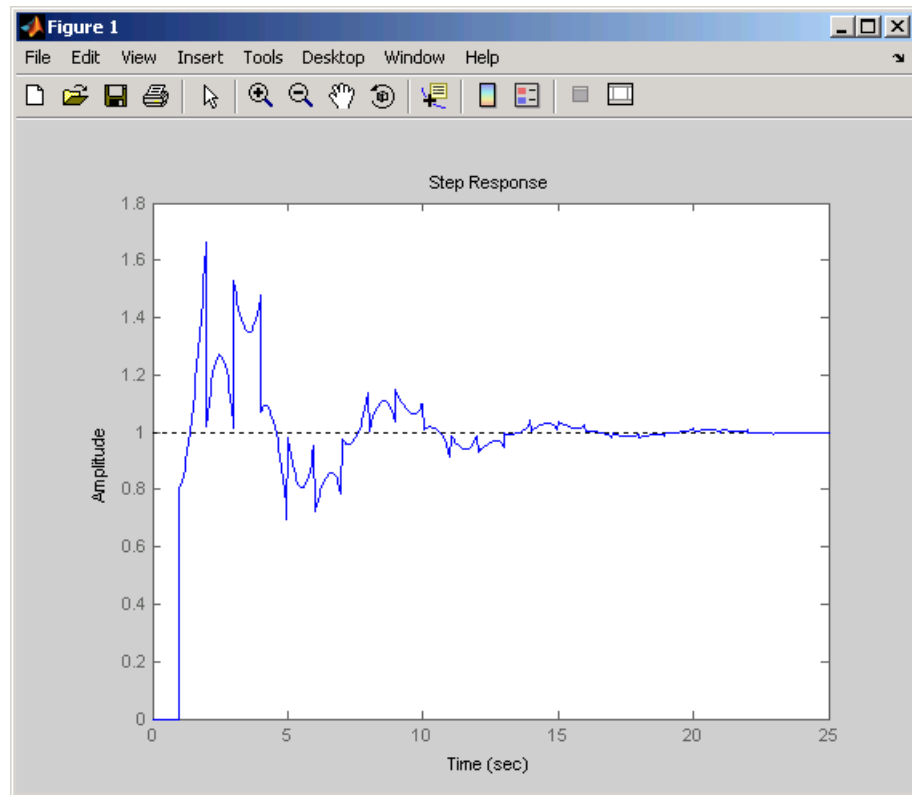
Note the rearrivals (echoes) of the initial step function.

Chaotic response:

$$G = \text{ss}(1/(s+1)) + \exp(-4*s);$$

$$T = \text{feedback}(1,G);$$

step(T)

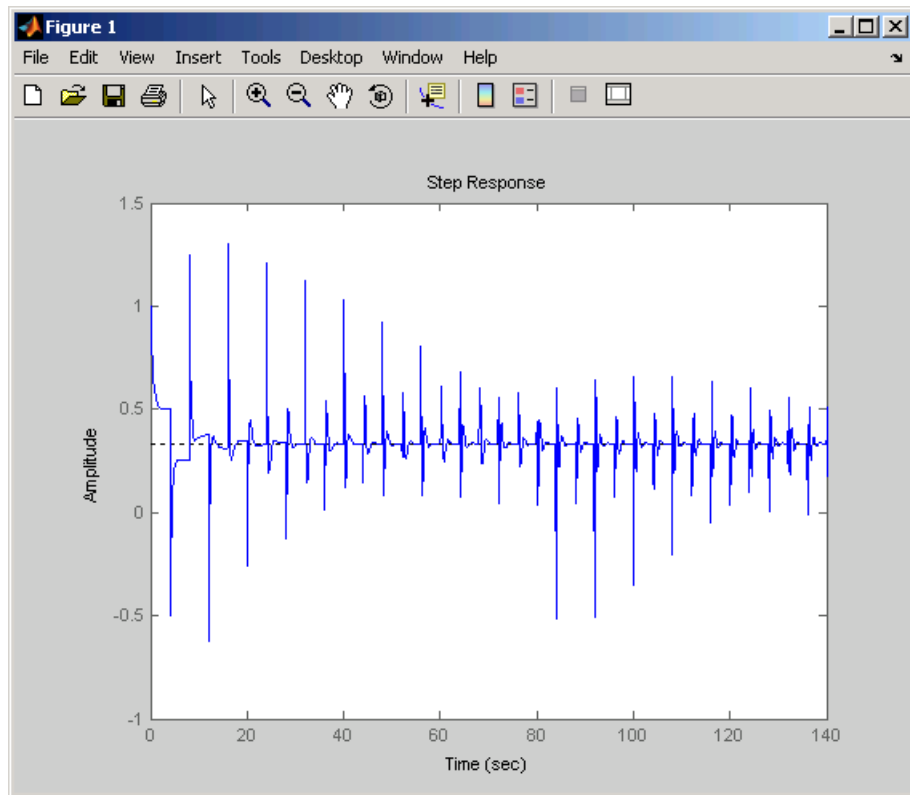

You can use Control System Toolbox tools to model and analyze these and other strange-appearing artifacts of internal delays.

Frequency Domain Analysis

- “Choosing a Frequency-Domain Analysis Command” on page 7-2
- “Frequency Response of a SISO System” on page 7-3
- “Frequency Response of a MIMO System” on page 7-5
- “System Characteristics on Response Plots” on page 7-9
- “Numeric Values of Frequency-Domain Characteristics of SISO Model” on page 7-12
- “Pole and Zero Locations” on page 7-15
- “Assessing Gain and Phase Margins” on page 7-18
- “Analyzing Control Systems with Delays” on page 7-31
- “Analyzing the Response of an RLC Circuit” on page 7-47

Choosing a Frequency-Domain Analysis Command

When you perform time-domain analysis of a dynamic system model, you may want one or more of the following:

- A plot of the system response as a function of frequency, or plots of pole and zero locations.
- Numerical values of the system response in a data array.
- Numerical values of characteristics of the system response such as stability margins, peak gains, or singular values.

Control System Toolbox frequency-domain analysis commands can obtain these results for any kind of dynamic system model (for example, continuous or discrete, SISO or MIMO, or arrays of models).

To obtain numerical data, use:

- `bode`, `bodemag`, `freqresp`, `nichols`, `nyquist` — System response data at a vector of frequency points.
- `margin`, `getPeakGain`, `getGainCrossover`, `sigma` — Numerical values of system response characteristics such as gain margins, phase margins, and singular values.

To obtain response plots, use:

- `bodeplot`, `nicholsplot`, `nyquistplot`, `sigmaplot`— Plot system response data, visualize response characteristics on plots, compare responses of multiple systems on a single plot.
- `ltiview` — Linear analysis tool for plotting many types of system responses simultaneously, including both time-domain and frequency-domain responses

To obtain pole-zero maps, use:

- `pzplot`, `iopzplot` — Plot pole and zero locations in the complex plane.

Frequency Response of a SISO System

This example shows how to plot the frequency response and obtain frequency response data for a single-input, single-output (SISO) dynamic system model.

Create a transfer function model and plot its frequency response.

```
H = tf([10,21],[1,1.4,26]);  
bodeplot(H)
```

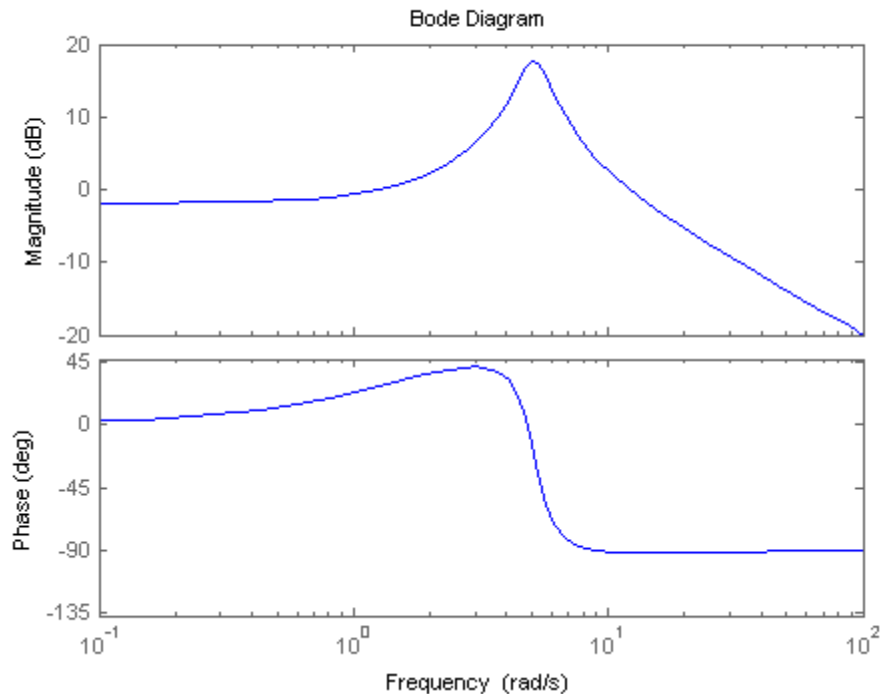

`bodeplot` plots the frequency response on the screen. Unless you specify a time range to plot, `stepplot` automatically chooses a time range that illustrates the system dynamics.

Calculate the frequency response between 1 and 13 rad/s.

```
[mag,phase,w] = bode(H,{1,13});
```

When you call `bode` with output arguments, the command returns vectors `mag` and `phase` containing the magnitude and phase of the frequency response. The cell array input `{1,13}` tells `bode` to calculate the response at a grid of frequencies between 1 and 13 rad/s. `bode` returns the frequency points in the vector `w`.

See Also

`bode` | `bodeplot` | `bodeoptions`

Related Examples

Concepts

- “Choosing a Frequency-Domain Analysis Command” on page 7-2

Frequency Response of a MIMO System

This example shows how to examine the frequency response of a multi-input, multi-output (MIMO) system in two ways: by computing the frequency response, and by computing the singular values.

Calculate the frequency response of a MIMO model and examine the size of the output.

```
H = rss(2,2,2);  
H.InputName = 'Control';  
H.OutputName = 'Temperature';  
[mag,phase,w] = bode(H);  
size(mag)
```

```
ans =
```

```
2     2    53
```

The first and second dimension of the data array `mag` are the number of outputs and inputs of `H`. The third dimension is the number of points in the frequency vector `w`. (The `bode` command determines this number automatically if you do not supply a frequency vector.) Thus, `mag(i,j,:)` is the frequency response from the `j`th input of `H` to the `i`th output, in absolute units. The phase data array `phase` takes the same form as `mag`.

Plot the frequency response of each input/output pair in `H`.

```
bodeplot(H)
```

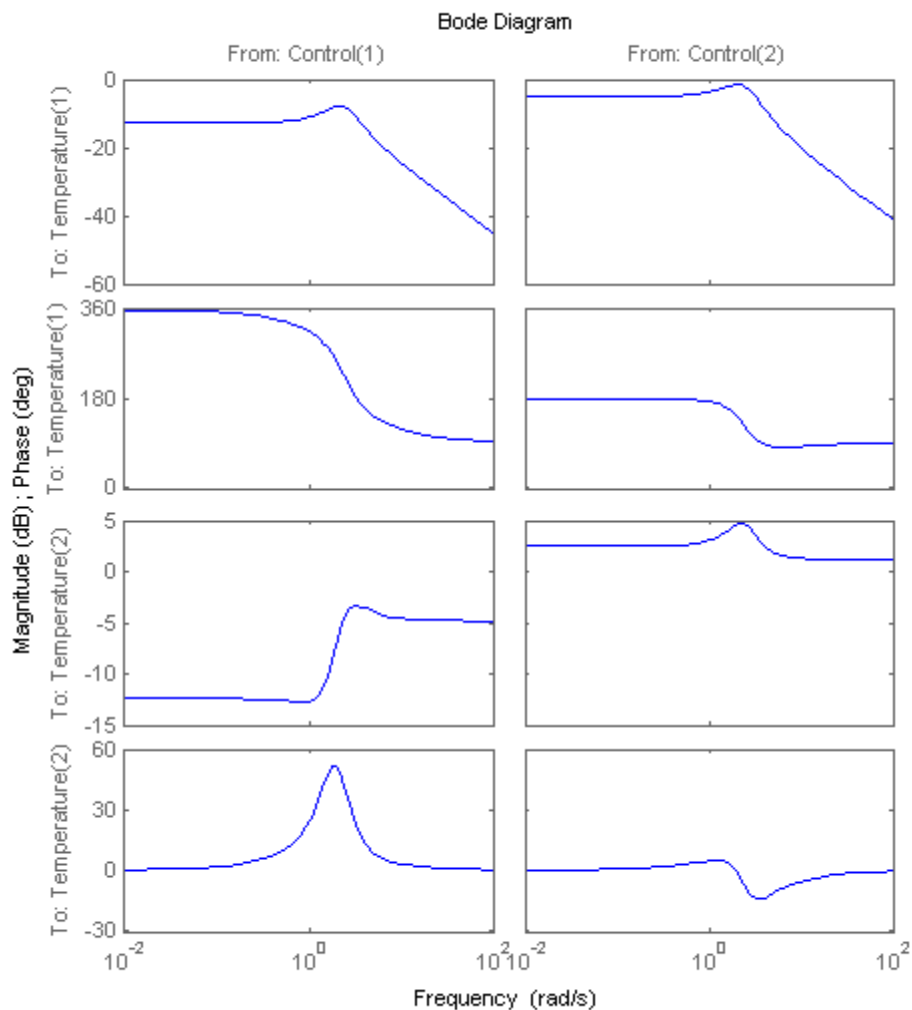

`bodeplot` plots the magnitude and the phase of the frequency response of each input/output pair in `H`. (Because `rss` generates a random state-space model, you might see different responses from those pictured.) The first column of plots shows the response from the first input, `Control(1)`, to each output.

The second column shows the response from the second input, Control(2), to each output.

Plot the singular values of H as a function of frequency.

```
sigmaplot(H)
```

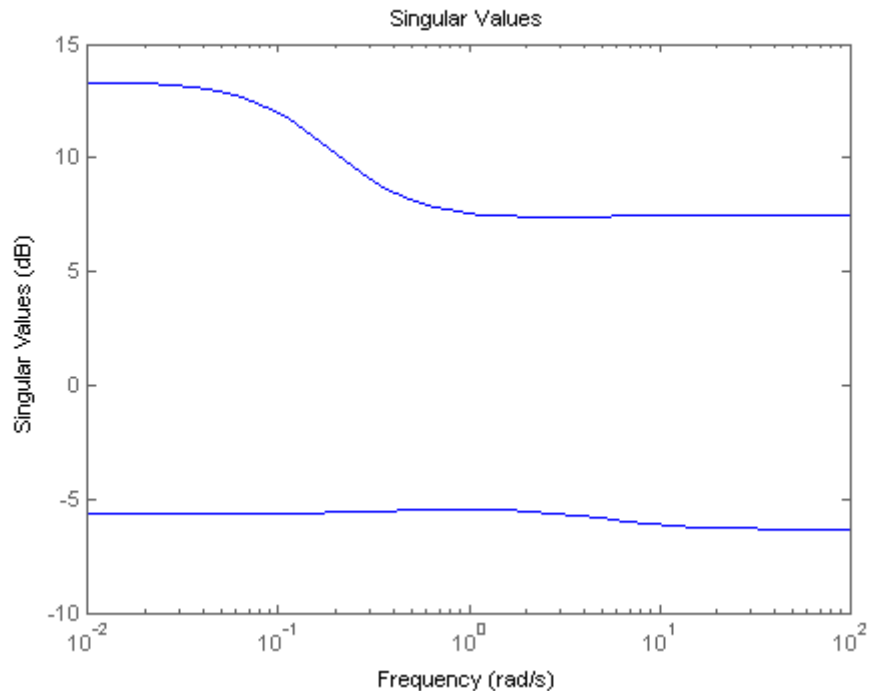

`sigmaplot` plots the singular values of the MIMO system H as a function of frequency. The maximum singular value at a particular frequency is the maximum gain of the system over all linear combinations of inputs at that frequency. Singular values can provide a better indication of the overall response, stability, and conditioning of a MIMO system than a channel-by-channel Bode plot.

Calculate the singular values of H between 0.1 and 10 rad/s.

```
[sv,w] = sigma(H,{0.1,10});
```

When you call `sigma` with output arguments, the command returns the singular values in the data array `sv`. The cell array input `{0.1,10}` tells `sigma` to calculate the singular values at a grid of frequencies between 0.1 and 10 rad/s. `sigma` returns these frequencies in the vector `w`. Each row of `sv` contains the singular values of `H` at the frequencies of `w`.

System Characteristics on Response Plots

This example shows how to display system characteristics such as peak response on Bode response plots.

You can use similar procedures to display system characteristics on other types of response plots.

Create a transfer function model and plot its frequency response.

```
H = tf([10,21],[1,1.4,26]);  
bodeplot(H)
```

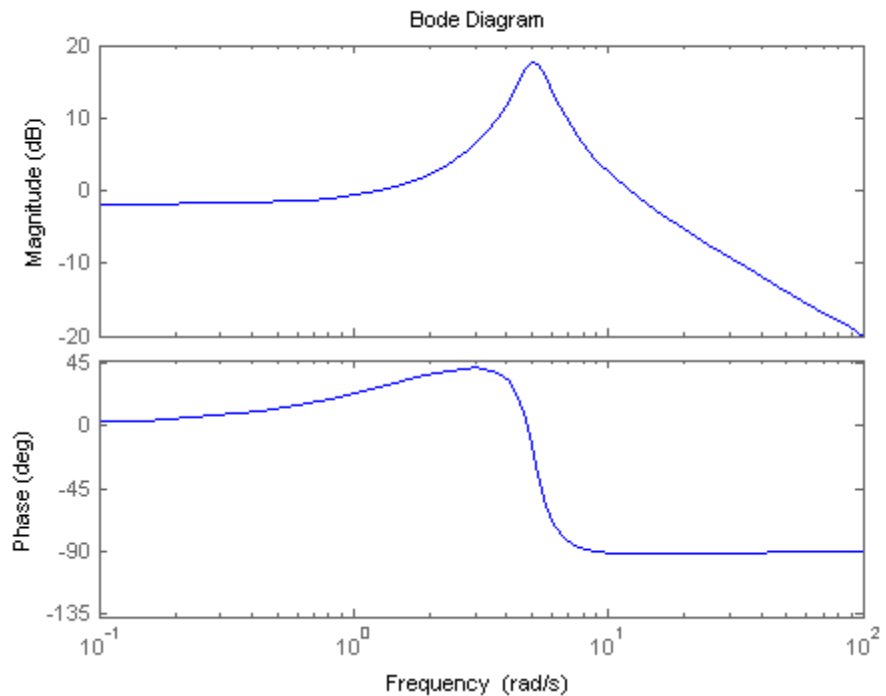

Display the peak response on the plot.

Right-click anywhere in the figure and select **Characteristics > Peak Response** from the menu.

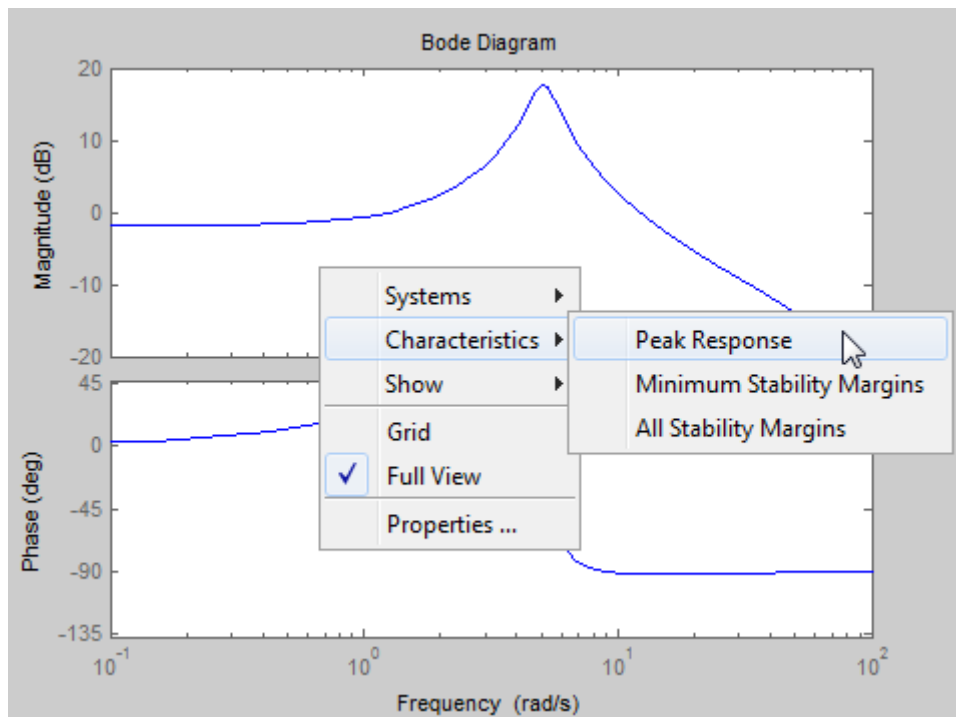

A marker appears on the plot indicating the peak response. Horizontal and vertical dotted lines indicate the frequency and magnitude of that response. The other menu options add other system characteristics to the plot.

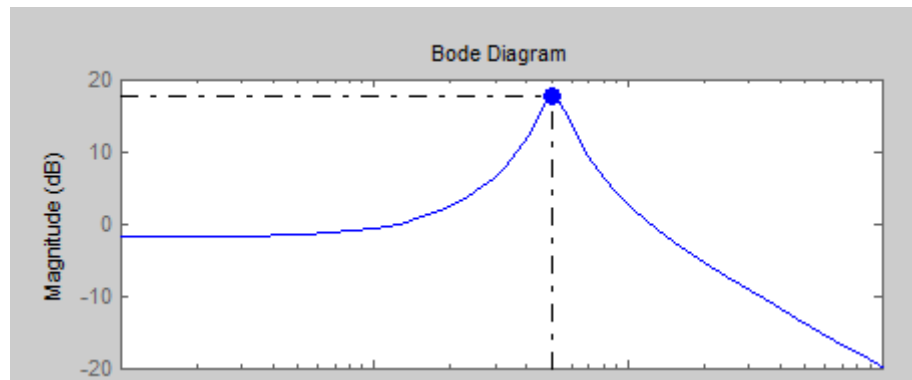

Click the marker to view the magnitude and frequency of the peak response in a datatip.

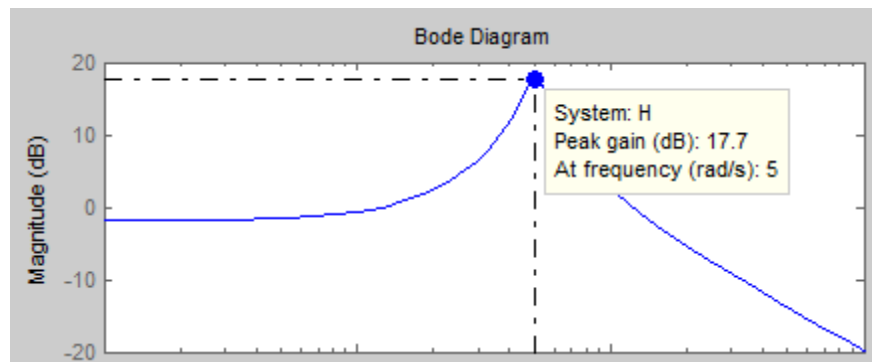

Numeric Values of Frequency-Domain Characteristics of SISO Model

This example shows how to obtain numeric values of several frequency-domain characteristics of a SISO dynamic system model, including the peak gain, dc gain, system bandwidth, and the frequencies at which the system gain crosses a specified frequency.

Create a transfer function model and plot its frequency response.

```
H = tf([10,21],[1,1.4,26]);  
bodeplot(H)
```

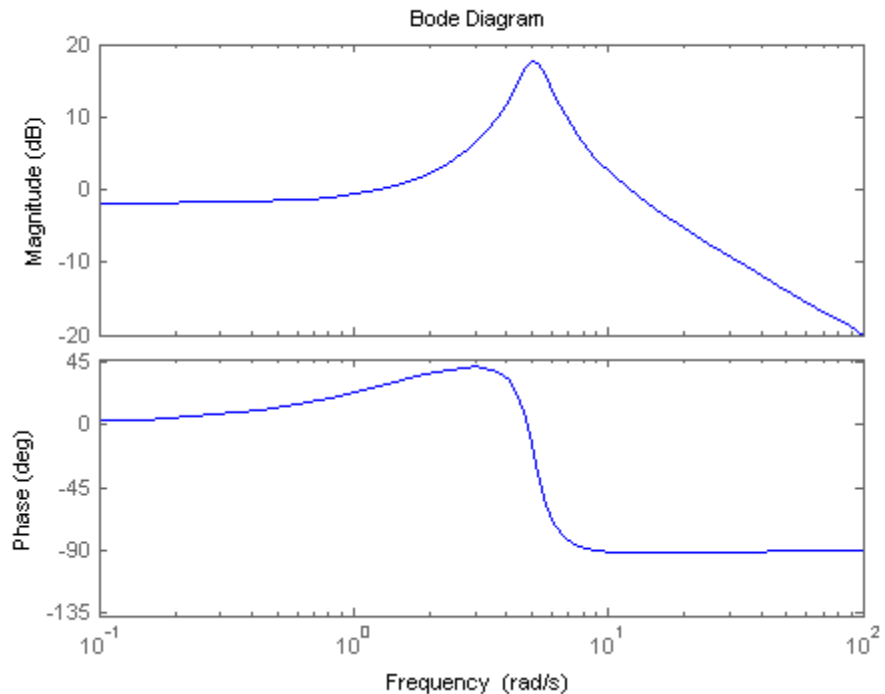

Plotting the frequency response gives a rough idea of the frequency-domain characteristics of the system. H includes a pronounced resonant peak, and

rolls off at 20 dB/decade at high frequency. It is often desirable to obtain specific numeric values for such characteristics.

Calculate the peak gain and the frequency of the resonance.

```
[gpeak, fpeak] = getPeakGain(H);  
gpeak_dB = mag2db(gpeak)
```

```
gpeak_dB =
```

```
17.7579
```

`getPeakGain` returns both the peak location `fpeak` and the peak gain `gpeak` in absolute units. Using `mag2db` to convert `gpeak` to decibels shows that the gain peaks at almost 18 dB.

Find the band within which the system gain exceeds 0 dB, or 1 in absolute units.

```
wc = getGainCrossover(H, 1)
```

```
wc =
```

```
1.2582  
12.1843
```

`getGainCrossover` returns a vector of frequencies at which the system response crosses the specified gain. The resulting `wc` vector shows that the system gain exceeds 0 dB between about 1.3 and 12.2 rad/s.

Find the dc gain of H.

The Bode response plot shows that the gain of H tends toward a finite value as the frequency approaches zero. The `dcbgain` command finds this value in absolute units.

```
k = dcbgain(H);
```

Find the frequency at which the response of H rolls off to -10 dB relative to its dc value.

```
fb = bandwidth(H, -10);
```

`bandwidth` returns the first frequency at which the system response drops below the dc gain by the specified value in dB.

Pole and Zero Locations

This example shows how to examine the pole and zero locations of dynamic systems both graphically using `pzplot` and numerically using `pole` and `zero`.

Examining the pole and zero locations can be useful for tasks such as stability analysis or identifying near-canceling pole-zero pairs for model simplification. This example compares two closed-loop systems that have the same plant and different controllers.

Create dynamic system models representing the two closed-loop systems.

```
G = zpk([], [-5 -5 -10], 100);  
C1 = pid(2.9, 7.1);  
CL1 = feedback(G*C1, 1);  
C2 = pid(29, 7.1);  
CL2 = feedback(G*C2, 1);
```

The controller `C2` has a much higher proportional gain. Otherwise, the two closed-loop systems `CL1` and `CL2` are the same.

Graphically examine the pole and zero locations of `CL1` and `CL2`.

```
pzplot(CL1, CL2)  
grid
```

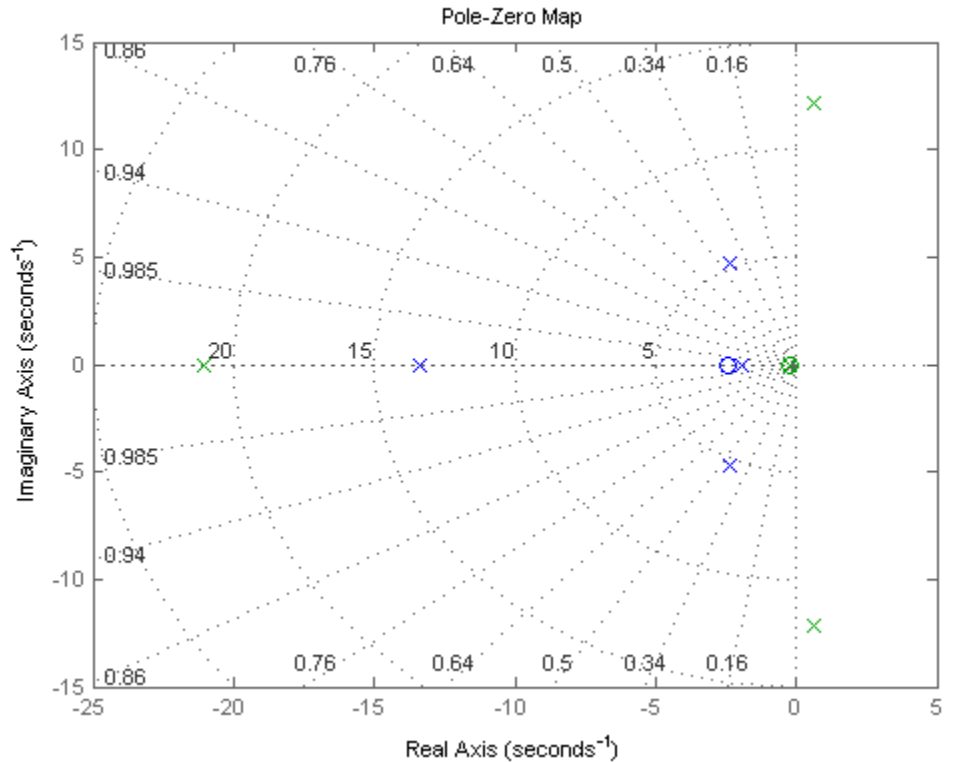

`pzplot` plots pole and zero locations on the complex plane as `x` and `o` marks, respectively. When you provide multiple models, `pzplot` plots the poles and zeros of each model in a different color. Here, there poles and zeros of CL1 are blue, and those of CL2 are green.

The plot shows that all poles of CL1 are in the left half-plane, and therefore CL1 is stable. From the radial grid markings on the plot, you can read that the damping of the oscillating (complex) poles is approximately 0.45. The plot also shows that CL2 contains poles in the right half-plane and is therefore unstable.

Compute numerical values of the pole and zero locations of CL2.

```
z = zero(CL2);
```

```
p = pole(CL2);
```

`zero` and `pole` return column vectors containing the zero and pole locations of the system.

Assessing Gain and Phase Margins

This example shows how to examine the effect of stability margins on closed-loop response characteristics of a control system.

Stability of a Feedback Loop

Stability generally means that all internal signals remain bounded. This is a standard requirement for control systems to avoid loss of control and damage to equipment. For linear feedback systems, stability can be assessed by looking at the poles of the closed-loop transfer function. Consider for example the SISO feedback loop:

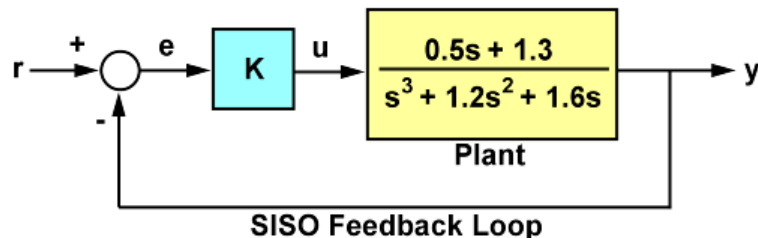

Figure 1: SISO Feedback Loop.

For a unit loop gain k , you can compute the closed-loop transfer function T using:

```
G = tf([.5 1.3],[1 1.2 1.6 0]);
T = feedback(G,1);
```

To obtain the poles of T , type

```
pole(T)
```

```
ans =
```

```
-0.2305 + 1.3062i
-0.2305 - 1.3062i
```

-0.7389

The feedback loop for $k=1$ is stable since all poles have negative real parts.

How Stable is Stable?

Checking the closed-loop poles gives us a binary assessment of stability. In practice, it is more useful to know how robust (or fragile) stability is. One indication of robustness is how much the loop gain can change before stability is lost. You can use the root locus plot to estimate the range of k values for which the loop is stable:

`rlocus(G)`

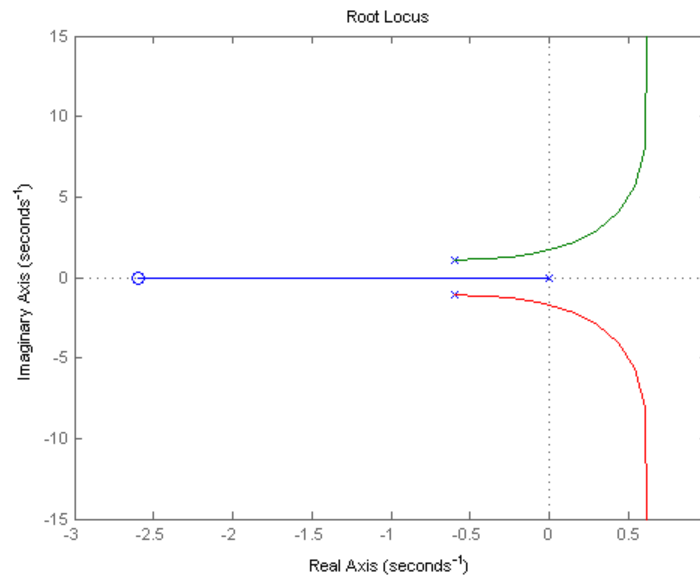

Clicking on the point where the locus intersects the y axis reveals that this feedback loop is stable for

$$0 < k < 2.7$$

This range shows that with $k=1$, the loop gain can increase 270% before you lose stability.

Gain and Phase Margins

Changes in the loop gain are only one aspect of robust stability. In general, imperfect plant modeling means that both gain and phase are not known exactly. Because modeling errors are most damaging near the gain crossover frequency (frequency where open-loop gain is 0dB), it also matters how much phase variation can be tolerated at this frequency.

The phase margin measures how much phase variation is needed at the gain crossover frequency to lose stability. Similarly, the gain margin measures what relative gain variation is needed at the gain crossover frequency to lose stability. Together, these two numbers give an estimate of the "safety margin" for closed-loop stability. The smaller the stability margins, the more fragile stability is.

You can display the gain and phase margins on a Bode plot as follows. First create the plot:

```
bode(G), grid
```

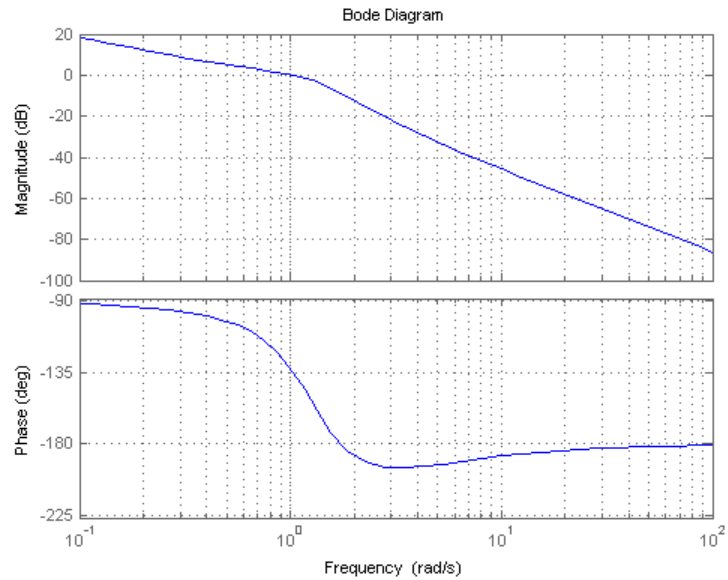

Then, right-click on the plot and select the **Characteristics -> Minimum Stability Margins** submenu. Finally, click on the blue dot markers. The resulting plot is shown below:

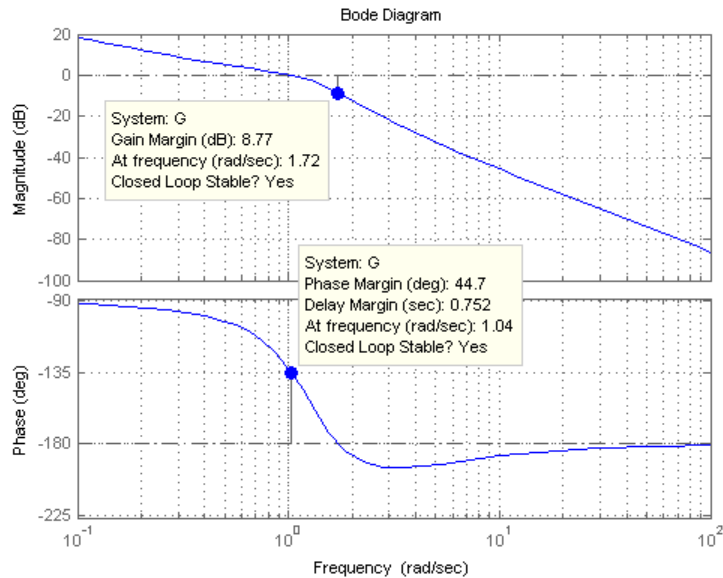

This indicates a gain margin of about 9 dB and a phase margin of about 45 degrees. The corresponding closed-loop step response exhibits about 20% overshoot and some oscillations.

```
step(T), title('Closed-loop response for k=1')
```

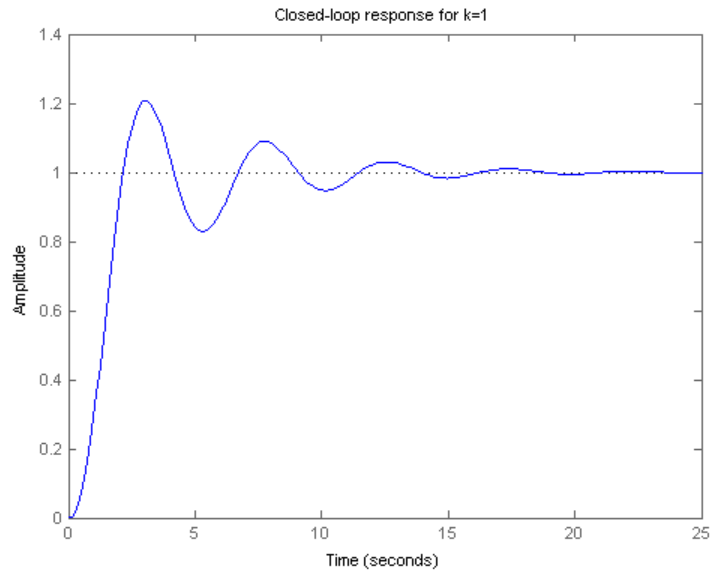
If we increase the gain to $k=2$, the stability margins are reduced to

```
[Gm,Pm] = margin(2*G);
GmdB = 20*log10(Gm) % gain margin in dB
Pm % phase margin in degrees
```

GmdB =

2.7471

Pm =

8.6328

and the closed-loop response has poorly damped oscillations, a sign of near instability.

```
step(feedback(2*G,1)), title('Closed-loop response for k=2')
```

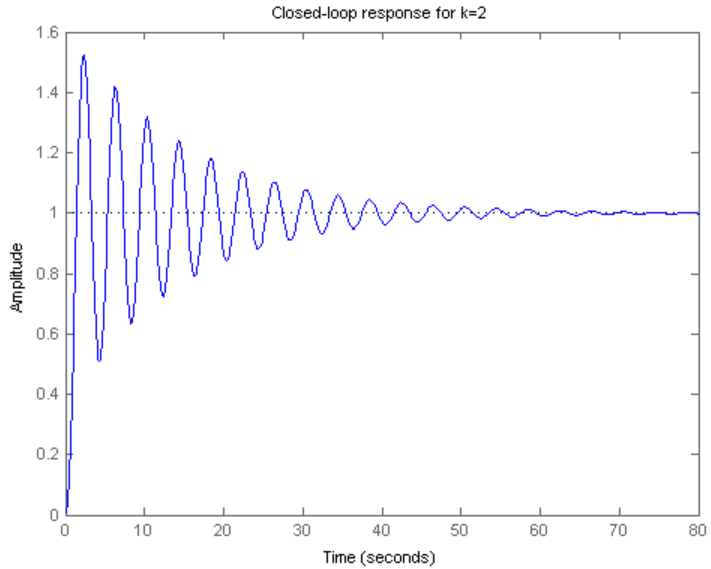

Systems with Multiple Gain or Phase Crossings

Some systems have multiple gain crossover or phase crossover frequencies, which leads to multiple gain or phase margin values. For example, consider the feedback loop

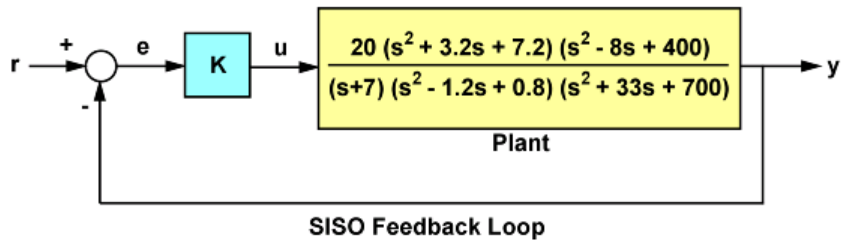
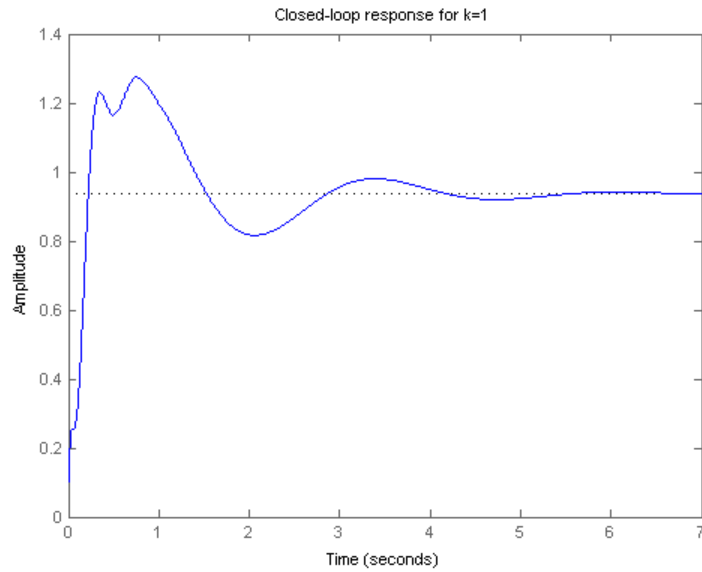

Figure 2: Feedback Loop with Multiple Phase Crossovers

The closed-loop response for $k=1$ is stable:

```
G = tf(20,[1 7]) * tf([1 3.2 7.2],[1 -1.2 0.8]) * tf([1 -8 400],[1 33 700])
T = feedback(G,1);
step(T), title('Closed-loop response for k=1')
```



To assess how robustly stable this loop is, plot its Bode response:

```
bode(G), grid
```

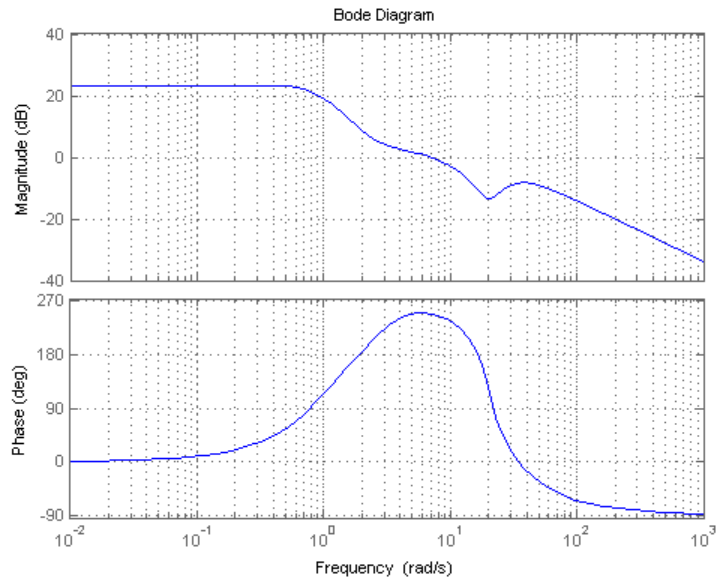

Then, right-click on the plot and select the **Characteristics** -> **All Stability Margins** submenu to show all the crossover frequencies and associated stability margins. The resulting plot is shown below.

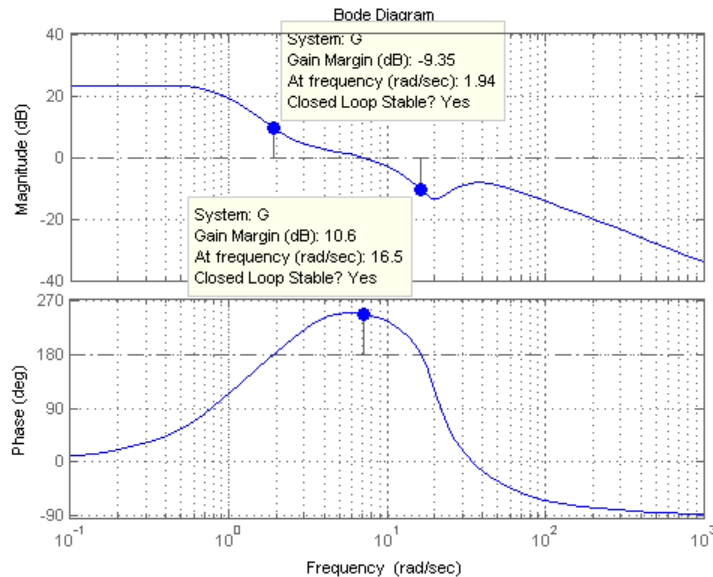

Note that there are two 180 deg phase crossings with corresponding gain margins of -9.35dB and +10.6dB. Negative gain margins indicate that stability is lost by decreasing the gain, while positive gain margins indicate that stability is lost by increasing the gain. This is confirmed by plotting the closed-loop step response for a plus/minus 6dB gain variation about $k=1$:

```
k1 = 2;    T1 = feedback(G*k1,1);
k2 = 1/2;  T2 = feedback(G*k2,1);
step(T, 'b', T1, 'r', T2, 'g', 12),
legend('k = 1', 'k = 2', 'k = 0.5')
```

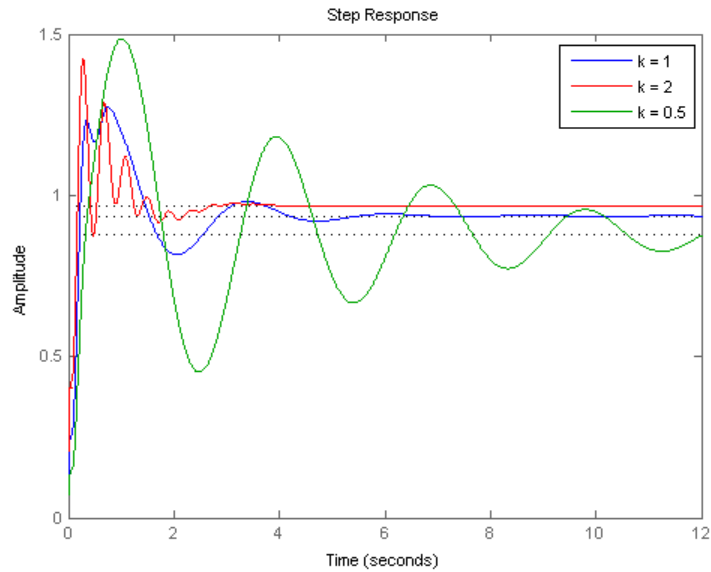

The plot shows increased oscillations for both smaller and larger gain values.

You can use the command `allmargin` to compute all stability margins. Note that gain margins are expressed as gain ratios, not dB. Use `mag2db` to convert the values to dB.

```
m = allmargin(G)
```

```
GainMargins_dB = mag2db(m.GainMargin)
```

```
m =
```

```
GainMargin: [0.3408 3.3920]
GMFrequency: [1.9421 16.4807]
PhaseMargin: 68.1178
PMFrequency: 7.0762
DelayMargin: 0.1680
DMFrequency: 7.0762
```

Stable: 1

GainMargins_dB =

-9.3510 10.6091

Interactive GUI

To gain additional insight into the connection between stability margins and closed-loop responses, click on the link below to launch an interactive GUI for tuning the loop gain k and seeing the effect on margins and closed-loop responses.

Open the Gain and Phase Margin GUI

`margin_gui`



Analyzing Control Systems with Delays

This example shows how to use Control System Toolbox™ to analyze and design control systems with delays.

Control of Processes with Delays

Many processes involve dead times, also referred to as transport delays or time lags. Controlling such processes is challenging because delays cause linear phase shifts that limit the control bandwidth and affect closed-loop stability.

Using the state-space representation, you can create accurate open- or closed-loop models of control systems with delays and analyze their stability and performance without approximation. The state-space (SS) object automatically keeps track of "internal" delays when combining models, see the "Specifying Time Delays" tutorial for more details.

Example: PI Control Loop with Dead Time

Consider the standard setpoint tracking loop:

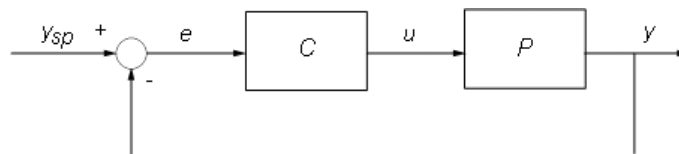

where the process model P has a 2.6 second dead time and the compensator C is a PI controller:

$$P(s) = \frac{e^{-2.6s}(s+3)}{s^2+0.3s+1}, \quad C(s) = 0.06\left(1 + \frac{1}{s}\right)$$

You can specify these two transfer functions as

```
s = tf('s');
P = exp(-2.6*s)*(s+3)/(s^2+0.3*s+1);
C = 0.06 * (1 + 1/s);
```

To analyze the closed-loop response, construct a model T of the closed-loop transfer from ysp to y. Because there is a delay in this feedback loop, you must convert P and C to state space and use the state-space representation for analysis:

```
T = feedback(P*C,1)
```

```
T =
```

```
a =  
      x1      x2      x3  
x1 -0.36 -1.24 -0.18  
x2  1      0      0  
x3  0      1      0
```

```
b =  
      u1  
x1  0.5  
x2  0  
x3  0
```

```
c =  
      x1      x2      x3  
y1  0.12  0.48  0.36
```

```
d =  
      u1  
y1  0
```

(values computed with all internal delays set to zero)

Internal delays (seconds): 2.6

Continuous-time state-space model.

The result is a third-order model with an internal delay of 2.6 seconds. Internally, the state-space object T tracks how the delay is coupled with the

remaining dynamics. This structural information is not visible to users, and the display above only gives the A,B,C,D values when the delay is set to zero.

Use the STEP command to plot the closed-loop step response from ysp to y:

```
step(T)
```

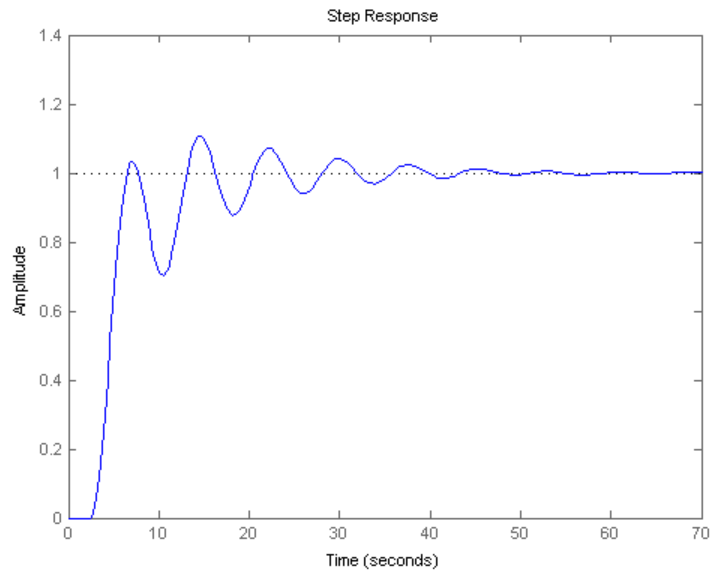

The closed-loop oscillations are due to a weak gain margin as seen from the open-loop response $P \cdot C$:

```
margin(P*C)
```

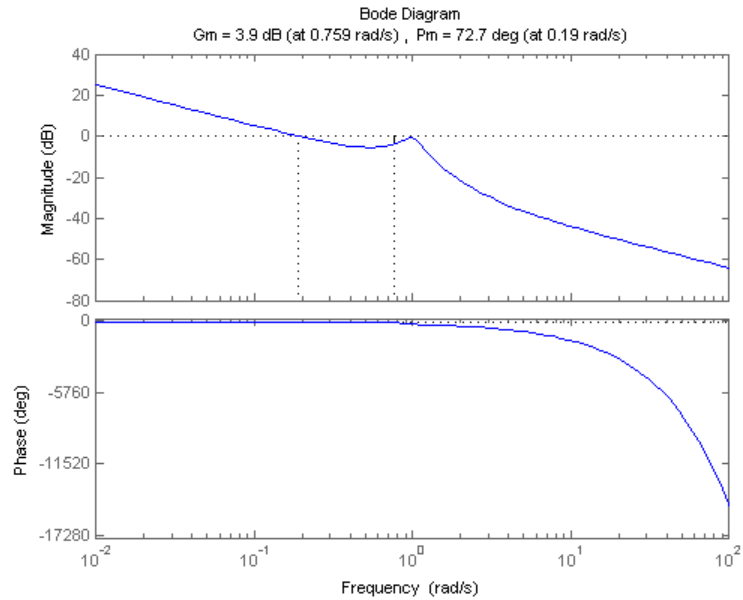

There is also a resonance in the closed-loop frequency response:

```
bode(T)  
grid, title('Closed-loop frequency response')
```

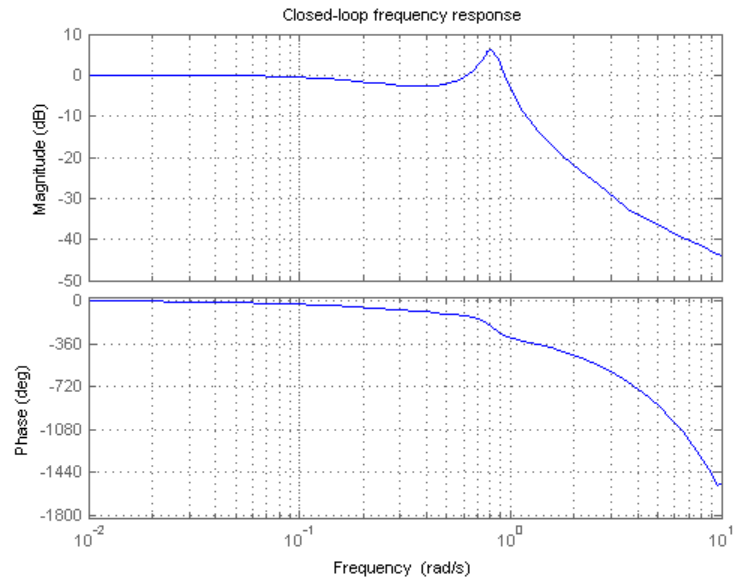

To improve the design, you can try to notch out the resonance near 1 rad/s:

```
notch = tf([1 0.2 1],[1 .8 1]);
C = 0.05 * (1 + 1/s);
Tnotch = feedback(P*C*notch,1);
```

```
step(Tnotch), grid
```

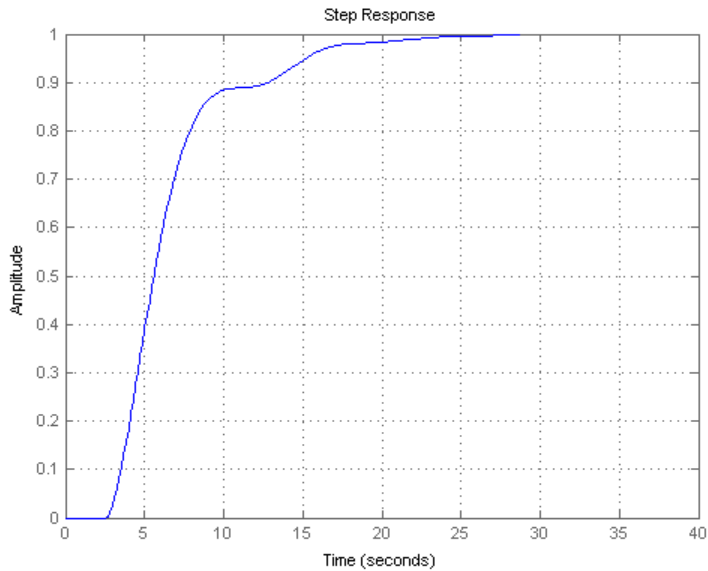

Pade Approximation of Time Delays

Many control design algorithms cannot handle time delays directly. A common workaround consists of replacing delays by their Pade approximations (all-pass filters). Because this approximation is only valid at low frequencies, it is important to compare the true and approximate responses to choose the right approximation order and check the approximation validity.

Use the PADE command to compute Pade approximations of LTI models with delays. For the PI control example above, you can compare the exact closed-loop response T with the response obtained for a first-order Pade approximation of the delay:

```
T1 = pade(T,1);
step(T, 'b', T1, 'r', 100)
grid, legend('Exact', 'First-Order Pade')
```

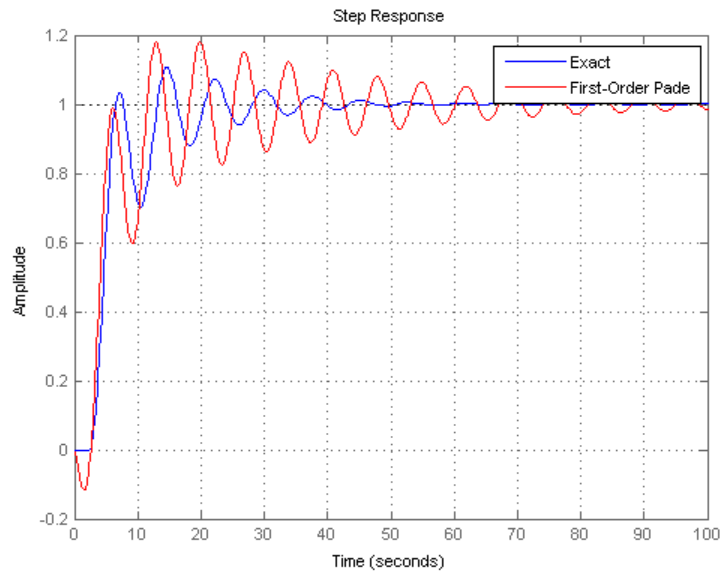

The approximation error is fairly large. To get a better approximation, try a second-order Pade approximation of the delay:

```
T2 = pade(T,2);  
step(T,'b',T2,'r',100)  
grid, legend('Exact','Second-Order Pade')
```

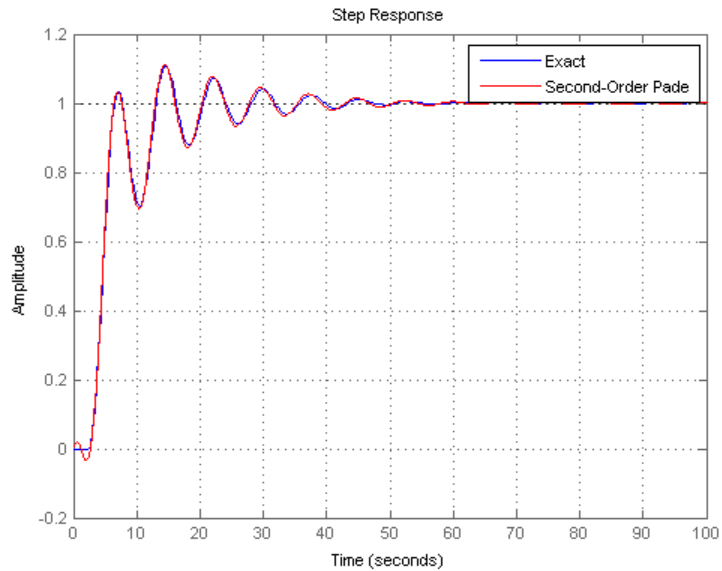

The responses now match closely except for the non-minimum phase artifact introduced by the Pade approximation.

Sensitivity Analysis

Delays are rarely known accurately, so it is often important to understand how sensitive a control system is to the delay value. Such sensitivity analysis is easily performed using LTI arrays and the InternalDelay property.

For example, to analyze the sensitivity of the notched PI control above, create 5 models with delay values ranging from 2.0 to 3.0:

```
tau = linspace(2,3,5); % 5 delay values
Tsens = repsys(Tnotch,[1 1 5]); % 5 copies of Tnotch
for j=1:5
    Tsens(:,:,j).InternalDelay = tau(j); % jth delay value -> jth model
end
```

Then use STEP to create an envelope plot:

```
step(Tsens)
grid, title('Closed-loop response for 5 delay values between 2.0 and 3.0')
```

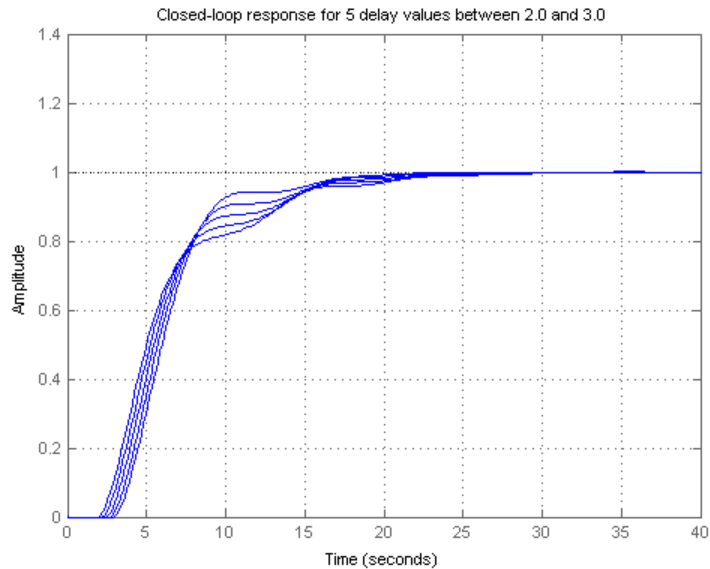

This plot shows that uncertainty on the delay value has little effect on closed-loop characteristics. Note that while you can change the values of internal delays, you cannot change how many there are because this is part of the model structure. To eliminate some internal delays, set their value to zero or use PADE with order zero:

```
Tnotch0 = Tnotch;
Tnotch0.InternalDelay = 0;
bode(Tnotch, 'b', Tnotch0, 'r', {1e-2, 3})
grid, legend('Delay = 2.6', 'No delay', 'Location', 'SouthWest')
```

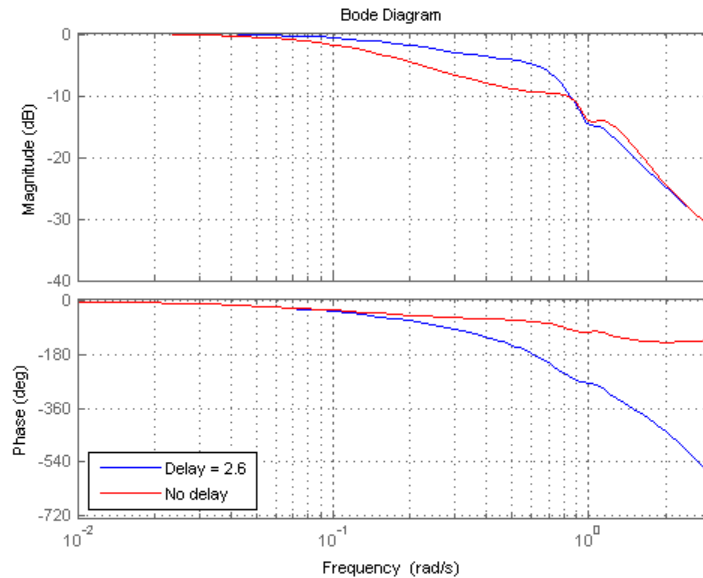

Discretization

You can use `C2D` to discretize continuous-time delay systems. Available methods include zero-order hold (ZOH), first-order hold (FOH), and Tustin. For models with internal delays, the ZOH discretization is not always "exact," i.e., the continuous and discretized step responses may not match:

```
Td = c2d(T,1);
step(T,'b',Td,'r')
grid, legend('Continuous','ZOH Discretization')
```

Warning: Discretization is only approximate due to internal delays. Use faster sampling rate if discretization error is large.

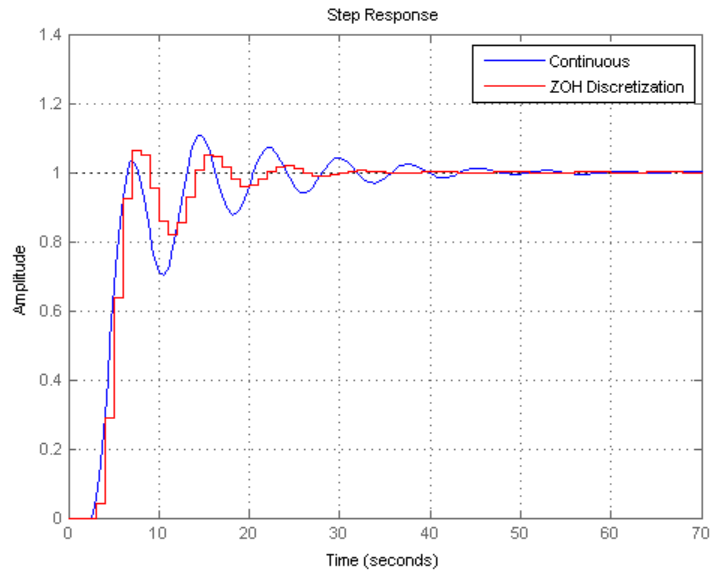

To correct such discretization gaps, reduce the sampling period until the continuous and discrete responses match closely:

```
Td = c2d(T,0.05);  
step(T,'b',Td,'r')  
grid, legend('Continuous','ZOH Discretization')
```

Warning: Discretization is only approximate due to internal delays. Use faster sampling rate if discretization error is large.

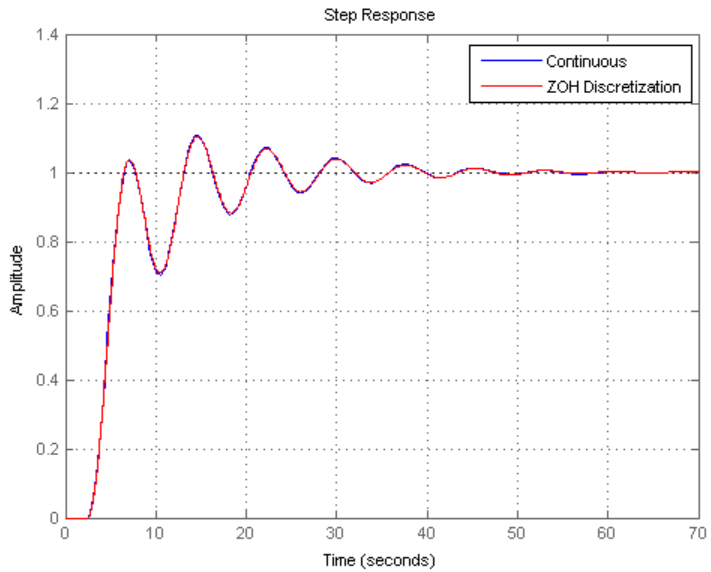

Note that internal delays remain internal in the discretized model and do not inflate the model order:

```
order(Td)
Td.InternalDelay
```

```
ans =
```

```
3
```

```
ans =
```

```
52
```

Some Unique Features of Delay Systems

The time and frequency responses of delay systems can look bizarre and suspicious to those only familiar with delay-free LTI analysis. Time responses can behave chaotically, Bode plots can exhibit gain oscillations, etc. These are not software quirks but real features of such systems. Below are a few illustrations of these phenomena

Gain ripples:

```
G = exp(-5*s)/(s+1);  
T = feedback(G, .5);  
bodemag(T)
```

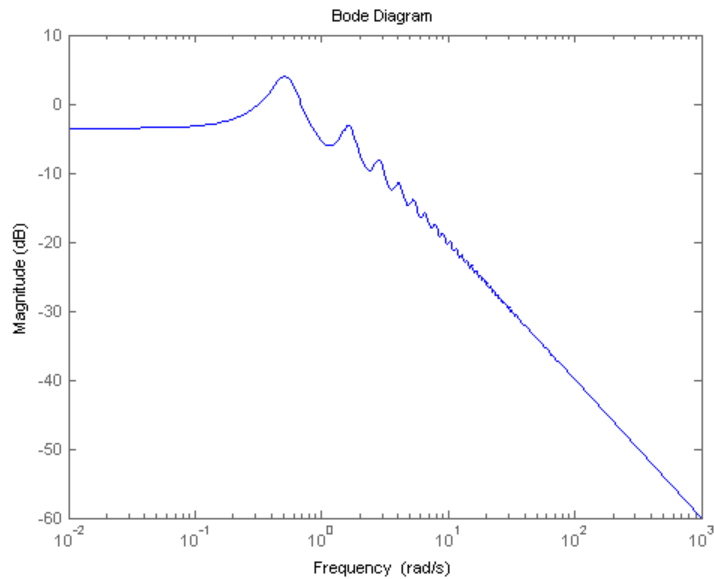

Gain oscillations:

```
G = 1 + 0.5 * exp(-3*s);  
bodemag(G)
```

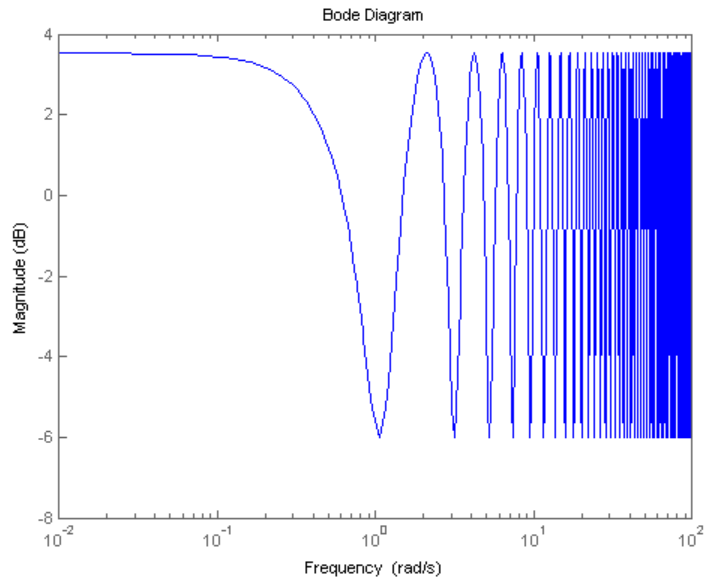

Jagged step response (note the "echoes" of the initial step):

```
G = exp(-s) * (0.8*s^2+s+2)/(s^2+s);  
T = feedback(G,1);  
step(T)
```

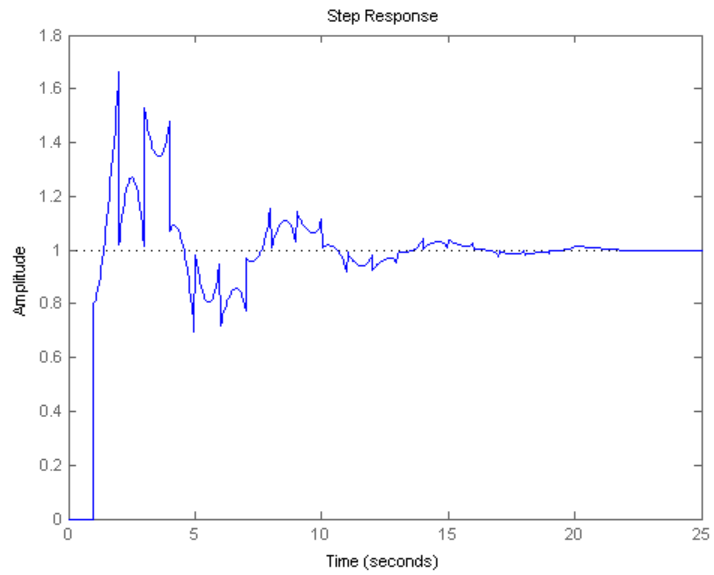

Chaotic response:

```
G = 1/(s+1) + exp(-4*s);
```

```
T = feedback(1,G);
```

```
step(T)
```

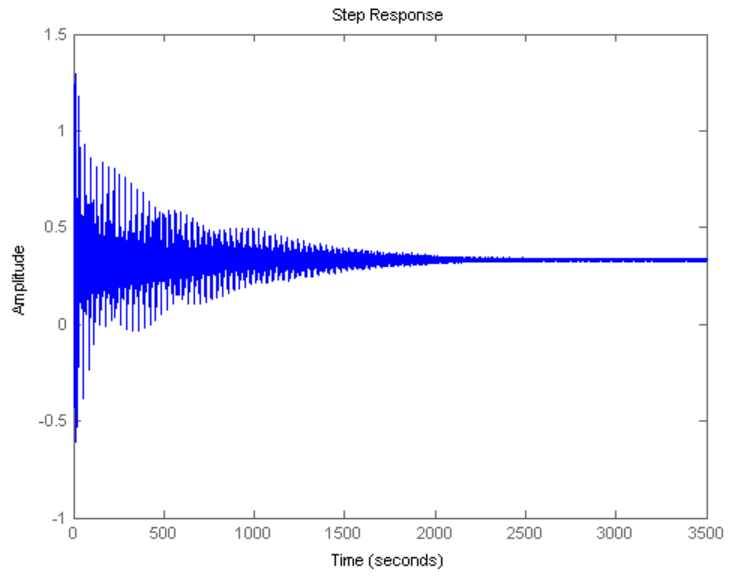

Analyzing the Response of an RLC Circuit

This example shows how to analyze the time and frequency responses of common RLC circuits as a function of their physical parameters using Control System Toolbox™ functions.

Bandpass RLC Network

The following figure shows the parallel form of a bandpass RLC circuit:

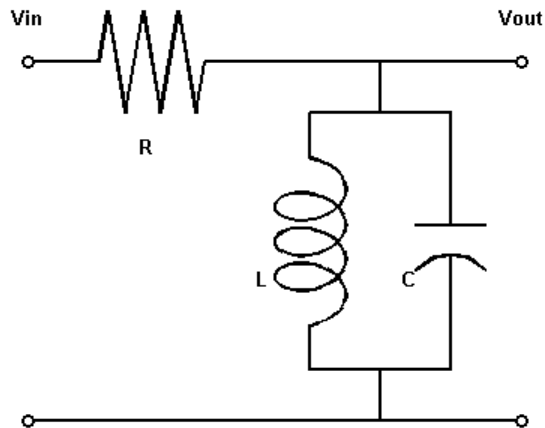

Figure 1: Bandpass RLC Network.

The transfer function from input to output voltage is:

$$G(s) = \frac{s/(RC)}{s^2 + s/(RC) + 1/(LC)}$$

The product LC controls the bandpass frequency while RC controls how narrow the passing band is. To build a bandpass filter tuned to the frequency 1 rad/s , set $L=C=1$ and use R to tune the filter band.

Analyzing the Frequency Response of the Circuit

The Bode plot is a convenient tool for investigating the bandpass characteristics of the RLC network. Use `tf` to specify the circuit's transfer function for the values

```
%|R=L=C=1|:  
R = 1; L = 1; C = 1;  
G = tf([1/(R*C) 0],[1 1/(R*C) 1/(L*C)])
```

G =

$$\frac{s}{s^2 + s + 1}$$

Continuous-time transfer function.

Next, use `bode` to plot the frequency response of the circuit:

```
bode(G), grid
```

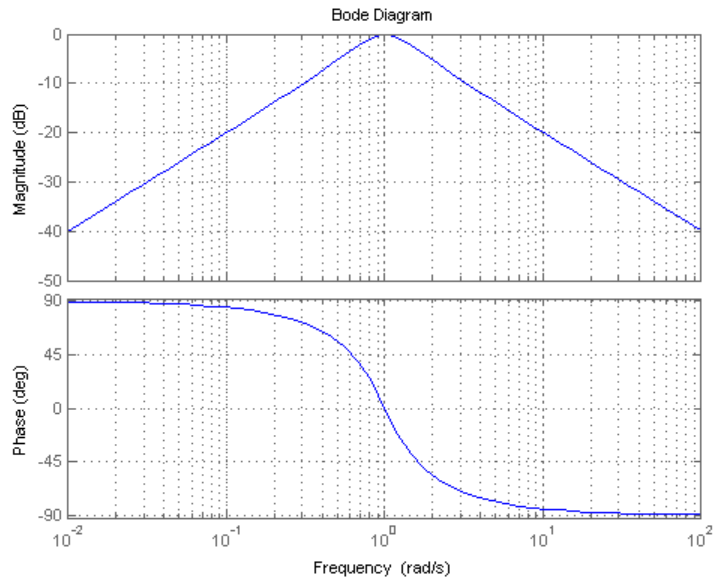

As expected, the RLC filter has maximum gain at the frequency 1 rad/s. However, the attenuation is only -10dB half a decade away from this frequency. To get a narrower passing band, try increasing values of R as follows:

```
R1 = 5;   G1 = tf([1/(R1*C) 0],[1 1/(R1*C) 1/(L*C)]);
R2 = 20;  G2 = tf([1/(R2*C) 0],[1 1/(R2*C) 1/(L*C)]);
bode(G,'b',G1,'r',G2,'g'), grid
legend('R = 1','R = 5','R = 20')
```

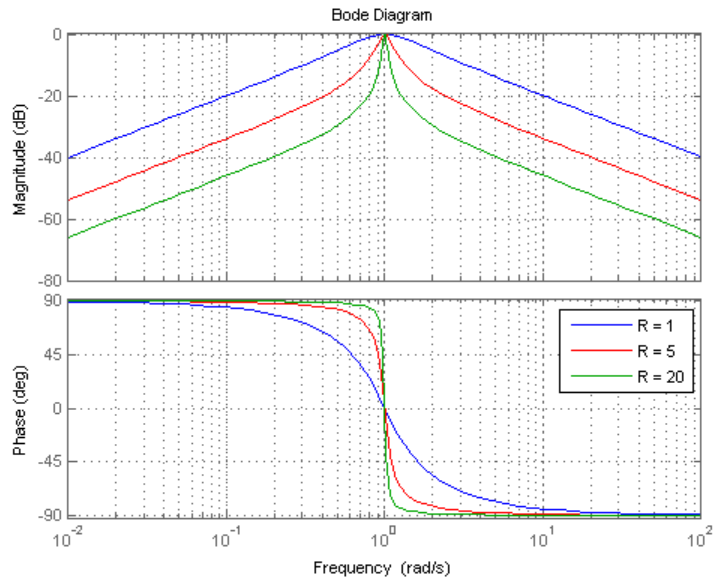

The resistor value $R=20$ gives a filter narrowly tuned around the target frequency of 1 rad/s.

Analyzing the Time Response of the Circuit

We can confirm the attenuation properties of the circuit G2 ($R=20$) by simulating how this filter transforms sine waves with frequency 0.9, 1, and 1.1 rad/s:

```
t = 0:0.05:250;
subplot(311), lsim(G2,sin(t),t), title('w = 1')
subplot(312), lsim(G2,sin(0.9*t),t), title('w = 0.9')
subplot(313), lsim(G2,sin(1.1*t),t), title('w = 1.1')
```

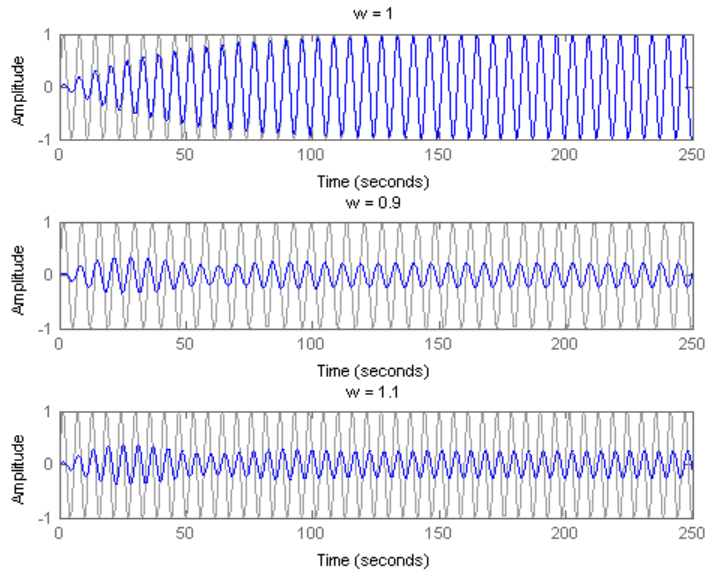

The waves at 0.9 and 1.1 rad/s are considerably attenuated. The wave at 1 rad/s comes out unchanged once the transients have died off. The long transient results from the poorly damped poles of the filters, which unfortunately are required for a narrow passing band:

```
damp(pole(G2))
```

Eigenvalue	Damping	Frequency
-2.50e-02 + 1.00e+00i	2.50e-02	1.00e+00
-2.50e-02 - 1.00e+00i	2.50e-02	1.00e+00

(Frequencies expressed in rad/TimeUnit)

Interactive GUI

To analyze other standard circuit configurations such as low-pass and high-pass RLC networks, click on the link below to launch an interactive GUI. In this GUI, you can change the R,L,C parameters and see the effect on the time and frequency responses in real time.

Open the RLC Circuit GUI

`rlc_gui`

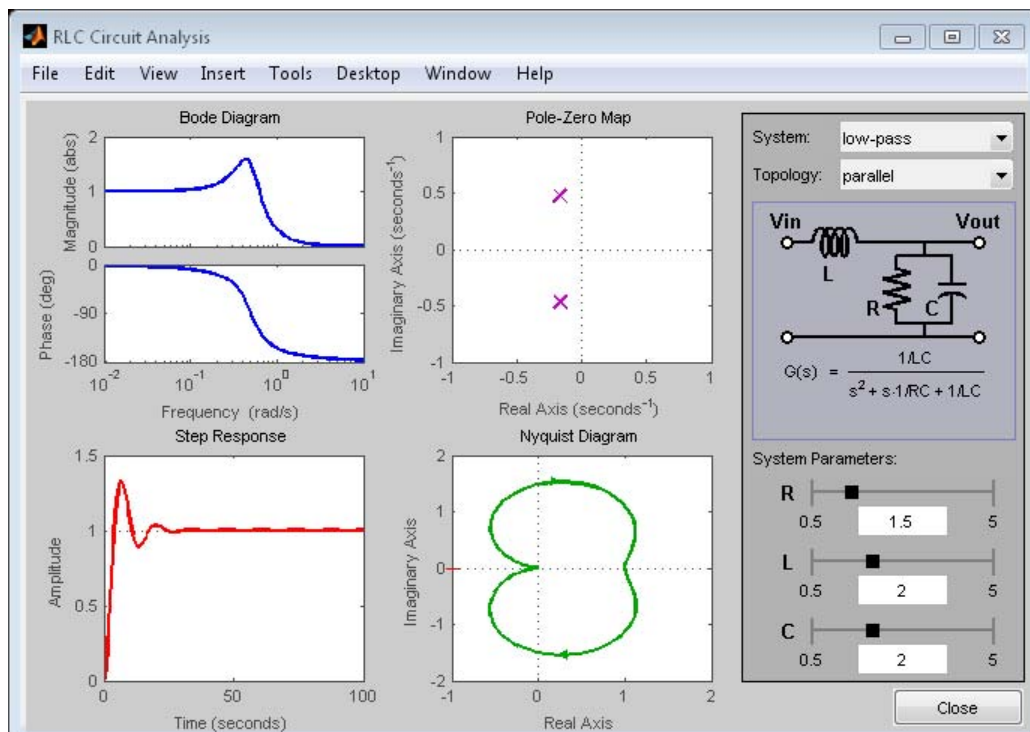

Sensitivity Analysis

- “Plant Model with Single-Parameter Variation” on page 8-2
- “Plant Model with Multiple-Parameter Variation” on page 8-4
- “Study Parameter Variation by Sampling Tunable Model” on page 8-6
- “Sensitivity of Control System to Time Delays” on page 8-8

Plant Model with Single-Parameter Variation

This example shows how to create a one-dimensional array of transfer functions using `stack`. One parameter of the transfer function varies from model to model in the array.

You can use such an array to investigate the effect of parameter variation on your model, such as for sensitivity analysis.

Create an array of transfer functions representing a low-pass filter

$F(s) = \frac{\alpha}{s + \alpha}$, at three values of the roll-off frequency α :

- 1 Create transfer function models representing the filter with roll-off frequency at $\alpha = 3, 5,$ and 7 .

```
F1 = tf(3,[1 3]);  
F2 = tf(5,[1 5]);  
F3 = tf(7,[1 7]);
```

- 2 Use `stack` to build an array.

```
Farray = stack(1,F1,F2,F3);
```

The first argument to `stack` specifies the array dimension along which `stack` builds an array. The remaining arguments specify the models to arrange along that dimension.

`Farray` is a 3-by-1 array of transfer functions.

Note Concatenating models with MATLAB array concatenation commands, instead of with `stack`, creates multi-input, multi-output (MIMO) models rather than model arrays. For example:

```
G = [F1;F2;F3]
```

creates a one-input, three-output transfer function model, not a 3-by-1 array.

- 3** Plot the frequency response of the array to examine the effect of parameter variation on the filter behavior.

```
bodeplot(Farray)
```

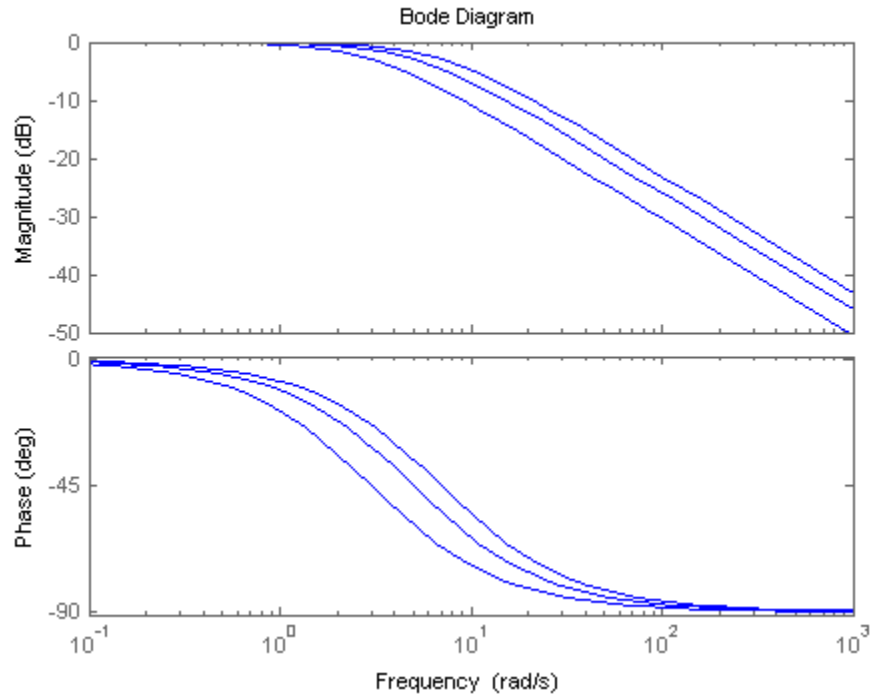

When you use analysis commands such as `bodeplot` on a model array, the resulting plot shows the response of each model in the array. Therefore, you can see the range of responses that results from the parameter variation.

Plant Model with Multiple-Parameter Variation

This example shows how to create a two-dimensional (2-D) array of transfer functions using for loops. One parameter of the transfer function varies in each dimension of the array.

You can use the technique of this example to create higher-dimensional arrays with variations of more parameters. Such arrays are useful for studying the effects of multiple-parameter variations on system response.

The second-order single-input, single-output (SISO) transfer function

$$H(s) = \frac{\omega^2}{s^2 + 2\zeta\omega s + \omega^2}.$$

depends on two parameters—the damping ratio ζ and natural frequency ω .

If both ζ and ω vary, you obtain multiple transfer functions of the form:

$$H_{ij}(s) = \frac{\omega_j^2}{s^2 + 2\zeta_i\omega_j s + \omega_j^2},$$

where ζ_i and ω_j represent different measurements or sampled values of the variable parameters.

You can collect all of these transfer functions in a single variable to create a two-dimensional model array.

1 (Optional) Preallocate memory for the model array.

You can enhance computation efficiency by preallocating memory. To do this, create an array of the required size and initialize its entries to zero.

```
H = tf(zeros(1,1,3,3));
```

In this example, there are three values for each parameter in the transfer function H . Therefore, this command creates a 3-by-3 array of single-input, single-output (SISO) zero transfer functions.

2 Create arrays containing the parameter values.

```
zeta = [0.66,0.71,0.75];
w = [1.0,1.2,1.5];
```

3 Build the array by looping through all combinations of parameter values.

```
for i = 1:length(zeta)
    for j = 1:length(w)
        H(:, :, i, j) = tf(w(j)^2, [1 2*zeta(i)*w(j) w(j)^2]);
    end
end
```

H is a 3-by-3 array of transfer functions. ζ varies as you move from model to model along a single column of H. The parameter ω varies as you move along a single row. Plotting the step response of H shows how the parameter variation affects the step response.

step(H)

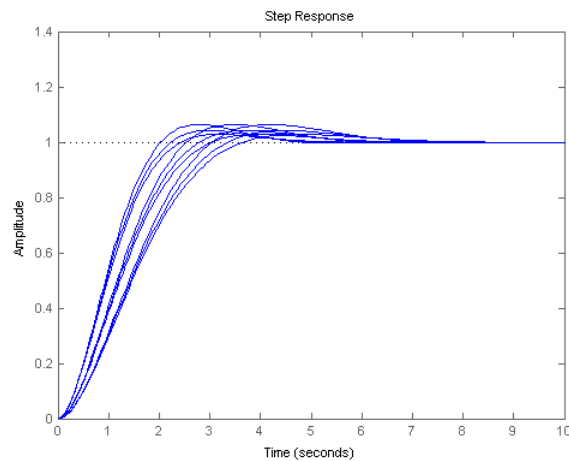

Study Parameter Variation by Sampling Tunable Model

This example shows how to sample a parametric model of a second-order filter across a grid of parameter values using `replaceBlock`.

- 1 Create a tunable (parametric) model of the second-order filter:

$$F(s) = \frac{\omega_n^2}{s^2 + 2\zeta\omega_n s + \omega_n^2},$$

where the damping ζ and the natural frequency ω_n are the parameters.

```
wn = realp('wn',3);  
zeta = realp('zeta',0.8);  
F = tf(wn^2,[1 2*zeta*wn wn^2]);
```

F is a genss model with two tunable Control Design Blocks, the `realp` blocks `wn` and `zeta`. The blocks `wn` and `zeta` have initial values of 3 and 0.8, respectively.

- 2 Sample F over a 2-by-3 grid of (wn,zeta) values.

```
Fsample = replaceBlock(F,'wn',[3;5],'zeta',[0.6 0.8 1.0]);
```

Fsample is 2-by-3 array of state-space models.

- 3 (Optional) Plot the step response of Fsample.

```
step(Fsample)
```

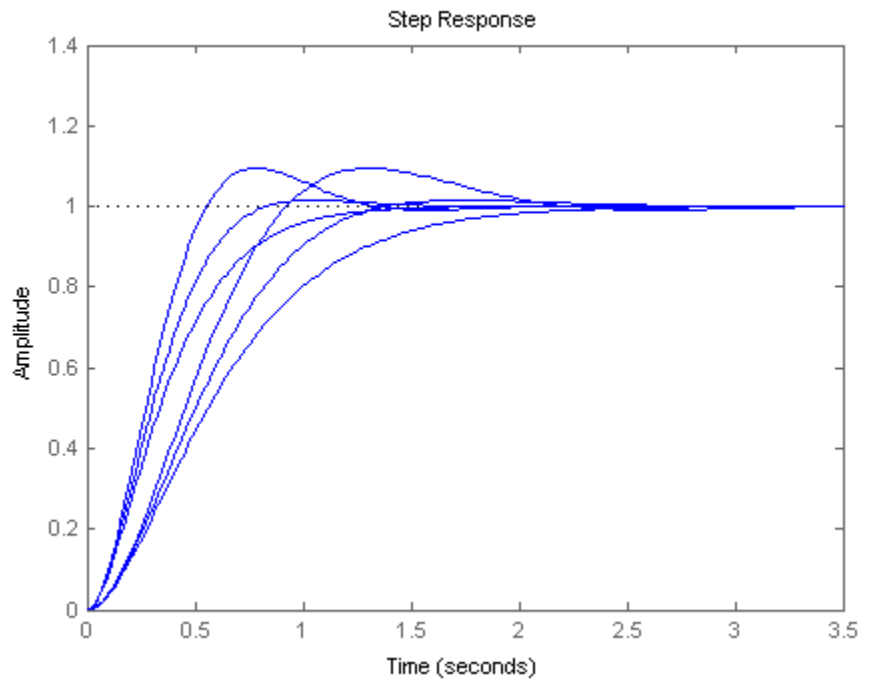

The step response plot show the variation in the natural frequency and damping constant across the six models in the array Fsamp1e.

Sensitivity of Control System to Time Delays

Delays are rarely known accurately, so it is often important to understand how sensitive a control system is to the delay value. Such sensitivity analysis is easily performed using LTI arrays and the `InternalDelay` property. For example, consider this notched PI control system developed in “PI Control Loop with Dead Time” from the example Analyzing Control Systems with Delays.

```
% Create a 3rd-order plant with a PI controller and notch filter.
s = tf('s');
P = exp(-2.6*s)*(s+3)/(s^2+0.3*s+1);
C = 0.06 * (1 + 1/s);
T = feedback(ss(P*C),1)
notch = tf([1 0.2 1],[1 .8 1]);
C = 0.05 * (1 + 1/s);
Tnotch = feedback(ss(P*C*notch),1);
```

Create five models with delay values ranging from 2.0 to 3.0:

```
tau = linspace(2,3,5);           % 5 delay values
Tsens = repsys(Tnotch,[1 1 5]); % 5 copies of Tnotch
                                   % for j=1:5
Tsens(:, :, j).InternalDelay = tau(j); % jth delay value
                                   % -> jth model end
% Use step to create an envelope plot.
step(Tsens)
grid
title('Closed-loop response for 5 delay values between 2.0 and 3.0')
```

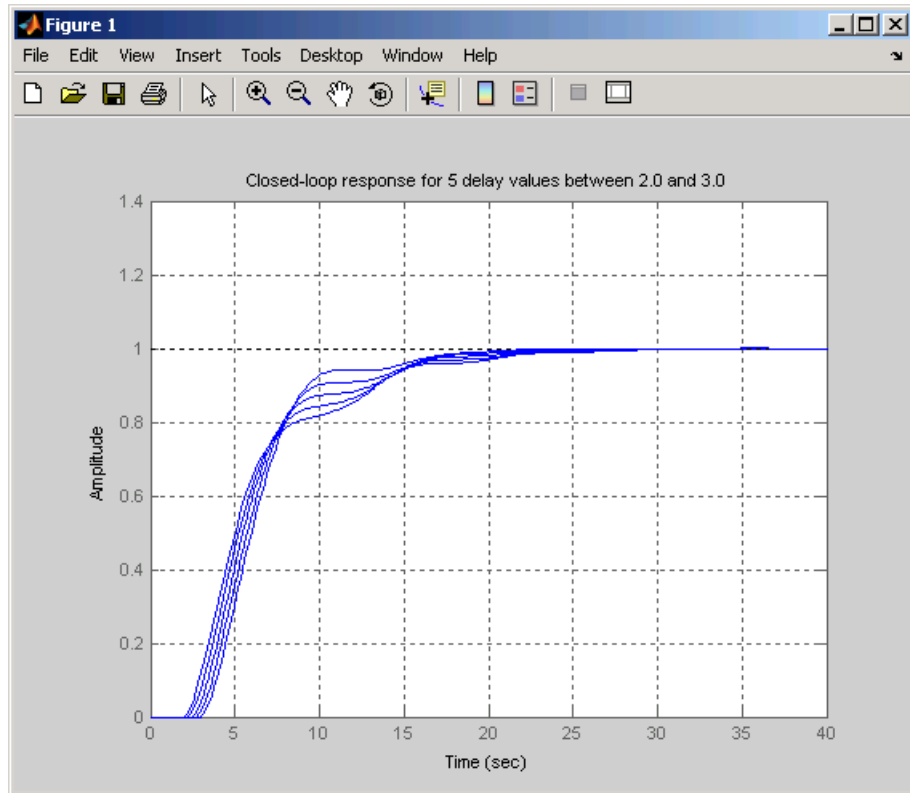

This plot shows that uncertainty on the delay value has little effect on closed-loop characteristics. Note that while you can change the values of internal delays, you cannot change how many there are because this is part of the model structure. To eliminate some internal delays, set their value to 0 or use `pade` with order zero:

```
Tnotch0 = Tnotch;
Tnotch0.InternalDelay = 0;
bode(Tnotch, 'b', Tnotch0, 'r', {1e-2, 3})
grid, legend('Delay = 2.6', 'No delay', 'Location', 'SouthWest')
```

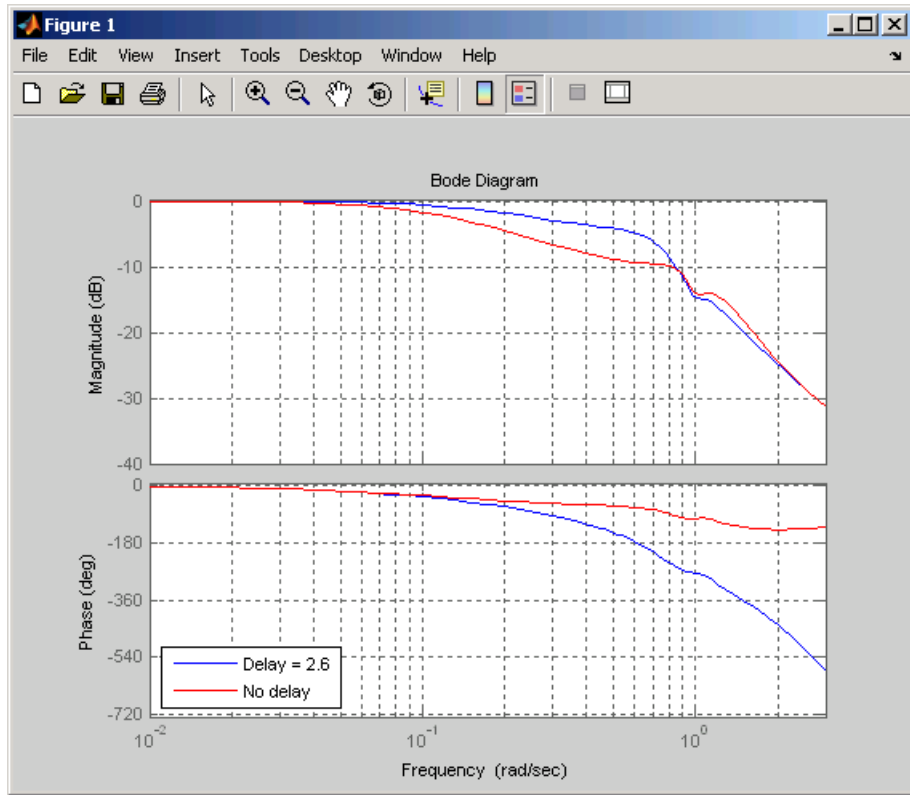

Control Design

- Chapter 9, “PID Controller Design”
- Chapter 10, “Single-Input, Single-Output Control Design”

PID Controller Design

- “PID Controller Design at the Command Line” on page 9-2
- “Designing Cascade Control System with PI Controllers” on page 9-8

PID Controller Design at the Command Line

This example shows how to design a PID controller for the plant

$$\text{sys} = \frac{1}{(s+1)^3}.$$

As a first pass, design a simple PI controller:

```
sys = zpk([],[-1 -1 -1],1); % define the plant
[C_pi,info] = pidtune(sys,'pi')
```

```
C_pi =
```

$$K_p + K_i * \frac{1}{s}$$

```
with Kp = 1.14, Ki = 0.454
```

Continuous-time PI controller in parallel form.

```
info =
```

```
Stable: 1
CrossoverFrequency: 0.5205
PhaseMargin: 60.0000
```

`C_pi` is a pid controller object that represents a PI controller. The fields of `info` show that the tuning algorithm chooses an open-loop crossover frequency of about 0.52 rad/s.

Examine the closed-loop step response (reference tracking) of the controlled system.

```
T_pi = feedback(C_pi*sys, 1);
step(T_pi)
```

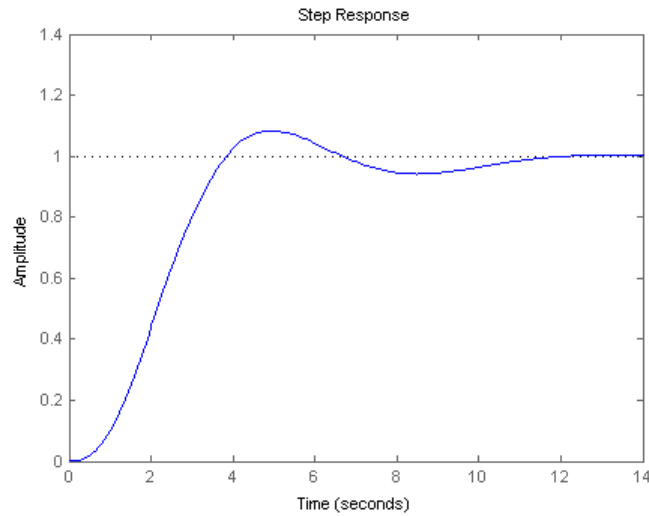

To improve the response time, you can set a higher target crossover frequency than the result that `pidtune` automatically selects, 0.52. Increase the crossover frequency to 1.0.

```
[C_pi_fast,info] = pidtune(sys,'pi',1.0)
```

```
C_pi_fast =
```

$$K_p + K_i * \frac{1}{s}$$

```
with Kp = 2.83, Ki = 0.0495
```

```
Continuous-time PI controller in parallel form.
```

```
info =
```

```
Stable: 1
CrossoverFrequency: 1
PhaseMargin: 43.9973
```

The new controller achieves the higher crossover frequency, but at the cost of a reduced phase margin.

Compare the closed-loop step response with the two controllers.

```
T_pi_fast = feedback(C_pi_fast*sys,1);
step(T_pi,T_pi_fast)
axis([0 30 0 1.4])
legend('C_pi','C_pi_fast')
```

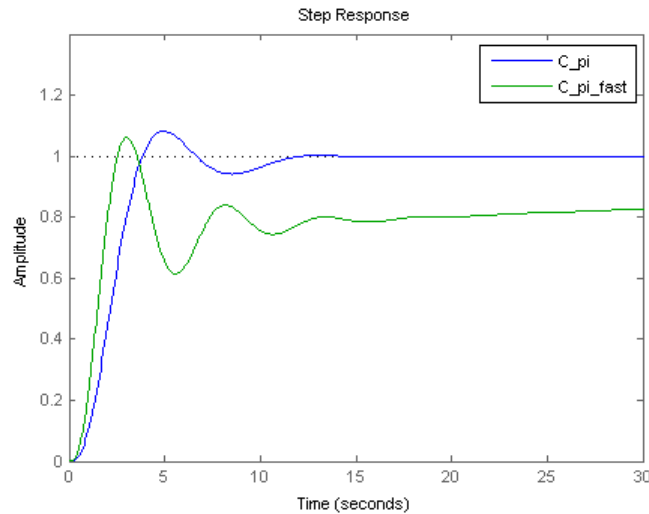

This reduction in performance results because the PI controller does not have enough degrees of freedom to achieve a good phase margin at a crossover frequency of 1.0 rad/s. Adding a derivative action improves the response.

Design a PIDF controller for G_c with the target crossover frequency of 1.0 rad/s.

```
[C_pidf_fast,info] = pidtune(sys,'pidf',1.0)

C_pidf_fast =
```

$$K_p + K_i * \frac{1}{s} + K_d * \frac{s}{T_f*s+1}$$

with $K_p = 2.72$, $K_i = 1.03$, $K_d = 1.76$, $T_f = 0.00875$

Continuous-time PIDF controller in parallel form.

info =

```

                Stable: 1
CrossoverFrequency: 1
                PhaseMargin: 60.0000

```

The fields of info show that the derivative action in the controller allows the tuning algorithm to design a more aggressive controller that achieves the target crossover frequency with a good phase margin.

Compare the closed-loop step response and disturbance rejection for the fast PI and PIDF controllers.

```

T_pidf_fast = feedback(C_pidf_fast*sys,1);
step(T_pi_fast, T_pidf_fast);
axis([0 30 0 1.4]);
legend('C_pi_fast', 'C_pidf_fast');

```

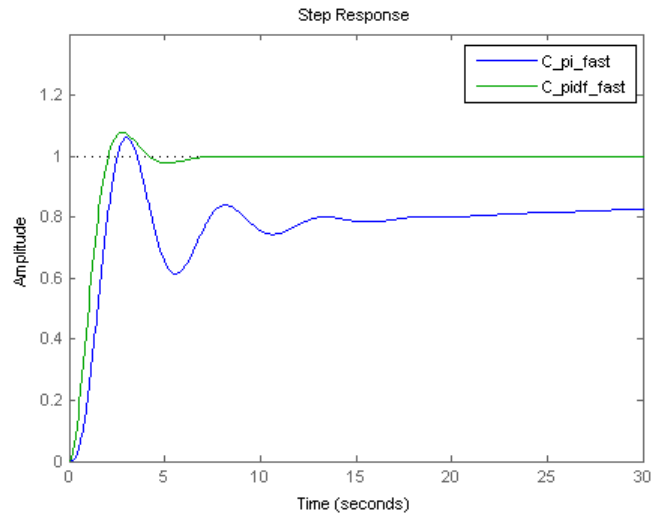

You can compare the input (load) disturbance rejection of the controlled system with the fast PI and PIDF controllers. To do so, plot the response of the closed-loop transfer function from the plant input to the plant output.

```
S_pi_fast = feedback(sys,C_pi_fast);  
S_pidf_fast = feedback(sys,C_pidf_fast);  
step(S_pi_fast,S_pidf_fast);  
axis([0 50 0 0.4]);  
legend('C_pi_fast','C_pidf_fast');
```

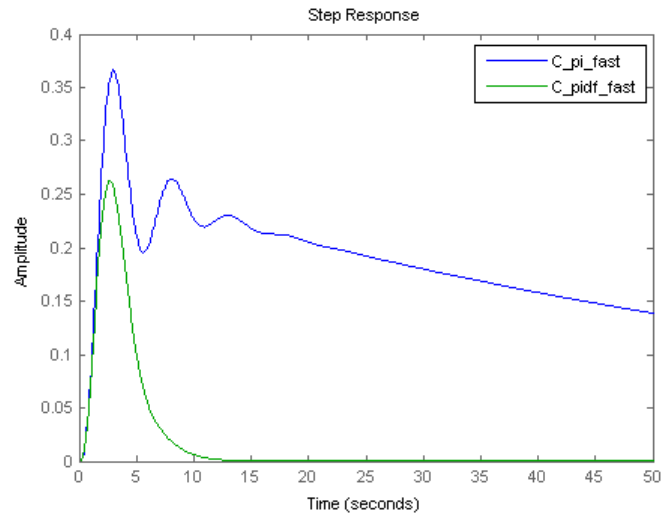
This plot shows that the PIDF controller also provides faster disturbance rejection.

Designing Cascade Control System with PI Controllers

This example shows how to design a cascade control loop with two PI controllers using the pidentune command.

Introduction to Cascade Control

Cascade control is mainly used to achieve fast rejection of disturbance before it propagates to the other parts of the plant. The simplest cascade control system involves two control loops (inner and outer) as shown in the block diagram below.

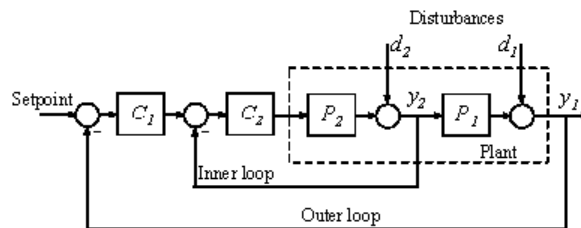

Controller **C1** in the outer loop is the primary controller that regulates the primary controlled variable **y1** by setting the set-point of the inner loop. Controller **C2** in the inner loop is the secondary controller that rejects disturbance **d2** locally before it propagates to **P1**. For a cascade control system to function properly, the inner loop must respond much faster than the outer loop.

In this example, you will design a single loop control system with a PI controller and a cascade control system with two PI controllers. The responses of the two control systems are compared for both reference tracking and disturbance rejection.

Plant

In this example, the inner loop plant **P2** is

$$P2(s) = \frac{3}{s + 2}$$

The outer loop plant P1 is

$$P1(s) = \frac{10}{(s+1)^3}$$

```
P2 = zpk([], -2, 3);
```

```
P1 = zpk([], [-1 -1 -1], 10);
```

Designing a Single Loop Control System with a PI Controller

Use **pidtune** command to design a PI controller in standard form for the whole plant model $P = P1 * P2$.

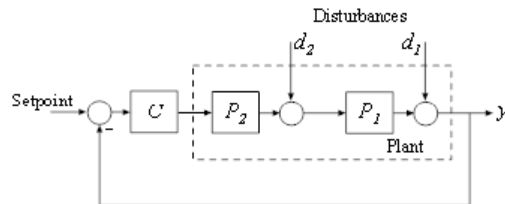

The desired open loop bandwidth is 0.2 rad/s, which roughly corresponds to the response time of 10 seconds.

```
% The plant model is P = P1*P2
P = P1*P2;
% Use a PID or PIDSTD object to define the desired controller structure
C = pidstd(1,1);
% Tune PI controller for target bandwidth is 0.2 rad/s
C = pidtune(P,C,0.2);
C
```

```
C =
```

$$K_p * \left(1 + \frac{1}{T_i} * \frac{1}{s} \right)$$

```
with Kp = 0.0119, Ti = 0.849
```

Continuous-time PI controller in standard form

Designing a Cascade Control System with Two PI Controllers

The best practice is to design the inner loop controller **C2** first and then design the outer loop controller **C1** with the inner loop closed. In this example, the inner loop bandwidth is selected as 2 rad/s, which is ten times higher than the desired outer loop bandwidth. In order to have an effective cascade control system, it is essential that the inner loop responds much faster than the outer loop.

Tune inner-loop controller C2 with open-loop bandwidth at 2 rad/s.

```
C2 = pidtune(P2,pidstd(1,1),2);
C2
```

C2 =

$$K_p * \left(1 + \frac{1}{T_i} * \frac{1}{s} \right)$$

with $K_p = 0.244$, $T_i = 0.134$

Continuous-time PI controller in standard form

Tune outer-loop controller C1 with the same bandwidth as the single loop system.

```
% Inner loop system when the control loop is closed first
clsys = feedback(P2*C2,1);
% Plant seen by the outer loop controller C1 is clsys*P1
C1 = pidtune(clsys*P1,pidstd(1,1),0.2);
C1
```

C1 =

$$K_p * \left(1 + \frac{1}{T_i} * \frac{1}{s} \right)$$

with $K_p = 0.015$, $T_i = 0.716$

Continuous-time PI controller in standard form

Performance Comparison

First, plot the step reference tracking responses for both control systems.

```
% single loop system for reference tracking
sys1 = feedback(P*C,1);
set(sys1,'Name','Single Loop');
% cascade system for reference tracking
sys2 = feedback(clsys*P1*C1,1);
set(sys2,'Name','Cascade');
% plot step response
figure;step(sys1,'r',sys2,'b')
legend('show','location','southeast')
title('Reference Tracking')
```

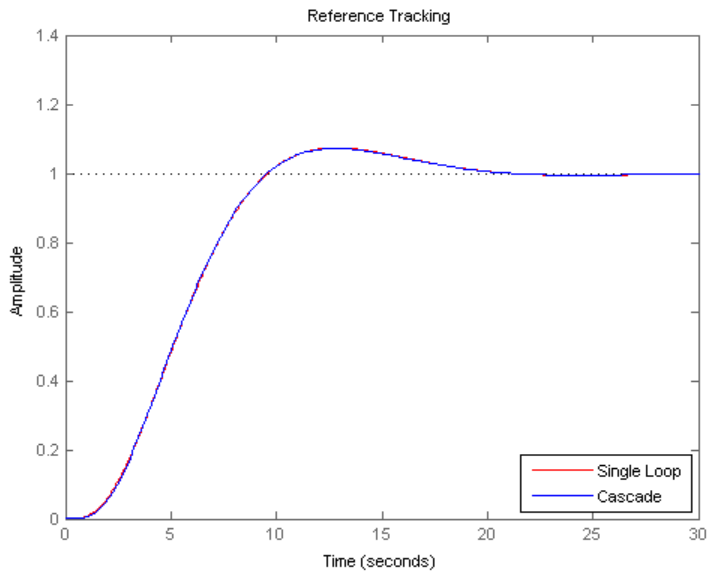

Secondly, plot the step disturbance rejection responses of d_2 for both control systems.

```
% single loop system for rejecting d2
sysd1 = feedback(P1,P2*C);
set(sysd1,'Name','Single Loop');
% cascade system for rejecting d2
sysd2 = P1/(1+P2*C2+P2*P1*C1*C2);
set(sysd2,'Name','Cascade');
% plot step response
figure;step(sysd1,'r',sysd2,'b')
legend('show')
title('Disturbance Rejection')
```

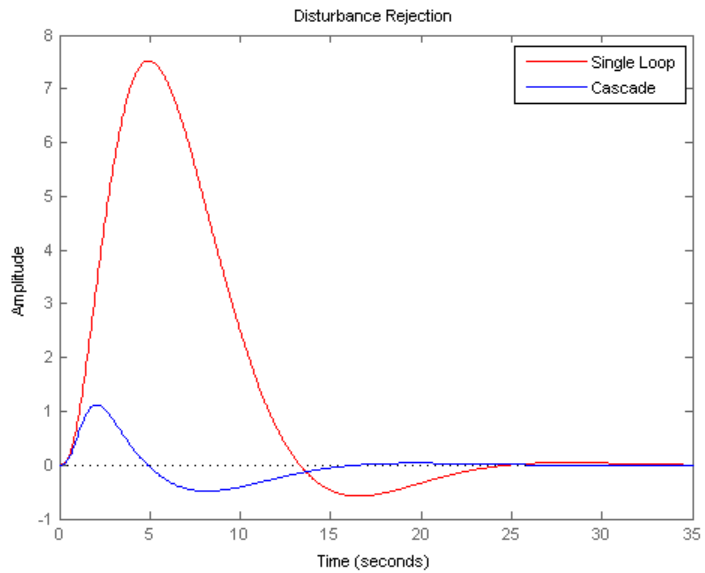

From the two response plots you can conclude that the cascade control system performs much better in rejecting disturbance d_2 while the set-point tracking performances are almost identical.

Single-Input, Single-Output Control Design

Getting Started with the SISO Design Tool

This example shows how the SISO Design Tool facilitates the compensator design process by providing interactive and automated tools to tune compensators for a feedback control system.

Compensator Design Task and the SISO Design Tool

The SISO Design Tool allows:

1) The design problem to be setup graphically by defining the control design requirement on time, frequency, and pole/zero response plots.

2) Tuning the compensator with:

- automated design methods such as Ziegler Nichols, IMC, and LQG.
- graphically tuning poles and zeros on design plots such as Bode and root locus.
- optimization to meet time and frequency-domain requirements using Simulink Design Optimization™.

3) While tuning the compensators, the closed-loop and open-loop responses are dynamically updated to display the performance of the control system.

The design process using the SISO Design Tool will be illustrated with an example problem.

Compensator Design Problem Example

For this example we will design a compensator for the system

$$G(s) = \frac{1}{s + 1}$$

with the following design requirements:

- Zero steady state error with respect to a step input.
- 80% rise time < 1 second.

- Settling time < 2 seconds.
- Maximum overshoot < 20%.
- Open-loop crossover constraint of less than 5 rad/s.

Launching the SISO Design Tool and Configuring Design Objectives

For this example we will use the standard feedback structure with the controller in the forward path which happens to be the default feedback structure when launching the SISO Design Tool. To launch the SISO Design Tool with the specified plant G type

```
>> sisotool(tf(1,[1,1]))
```

This will bring up two windows. The first window is Control and Estimation Tools Manager (CETM)

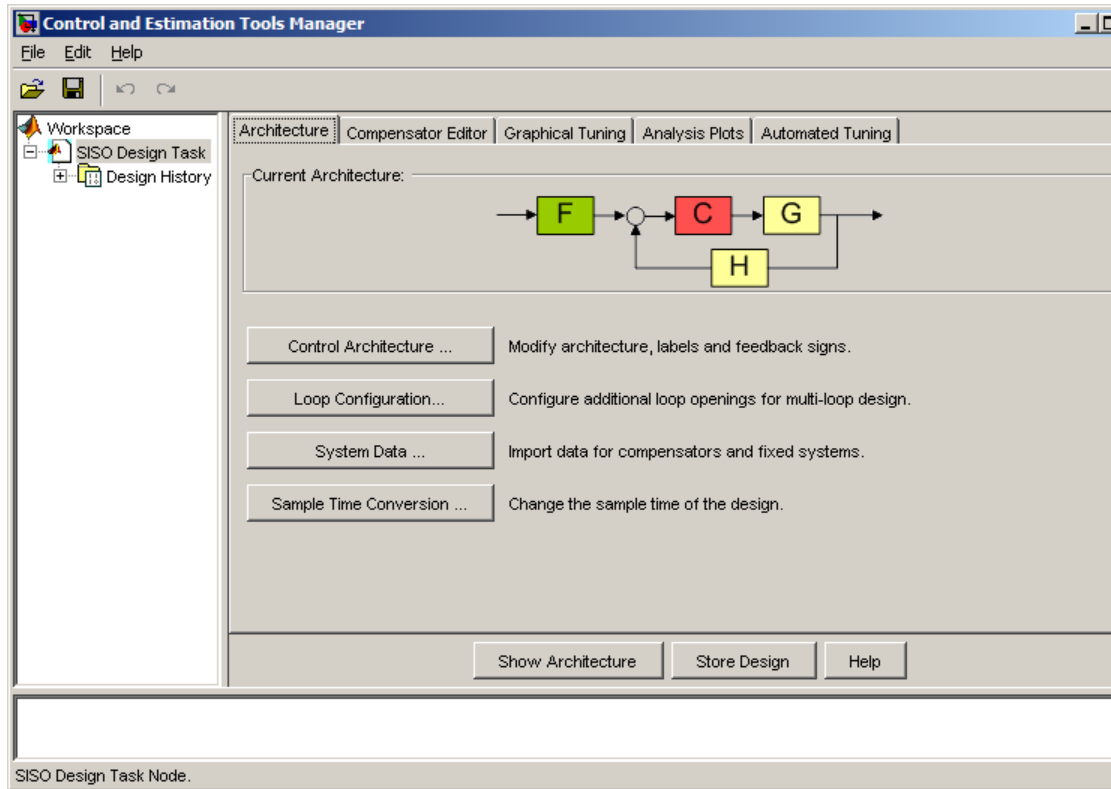

and the second window is the SISO Design graphical editors

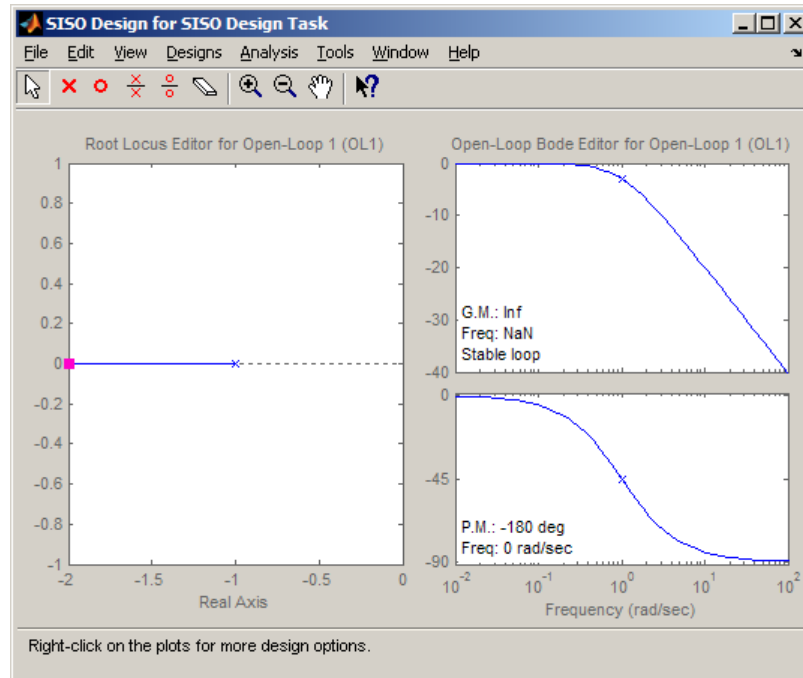

In the CETM the **SISO Design Task** node contains tabbed panels which are used to configure the compensator design options as well as manipulate the compensators. For complete details of the functionality for each of the panels refer to the documentation.

For this design example we will use the root-locus plot and open-loop Bode plot for graphically tuning the compensator and validate the design by viewing the step response.

To view the closed-loop step response, click on the **Analysis Plot** tab in the CETM. Now configure the plot by selecting "Step" for the first plot and checking the first check box for the response "Closed-Loop r to y". This will bring up the SISO Tool Viewer.

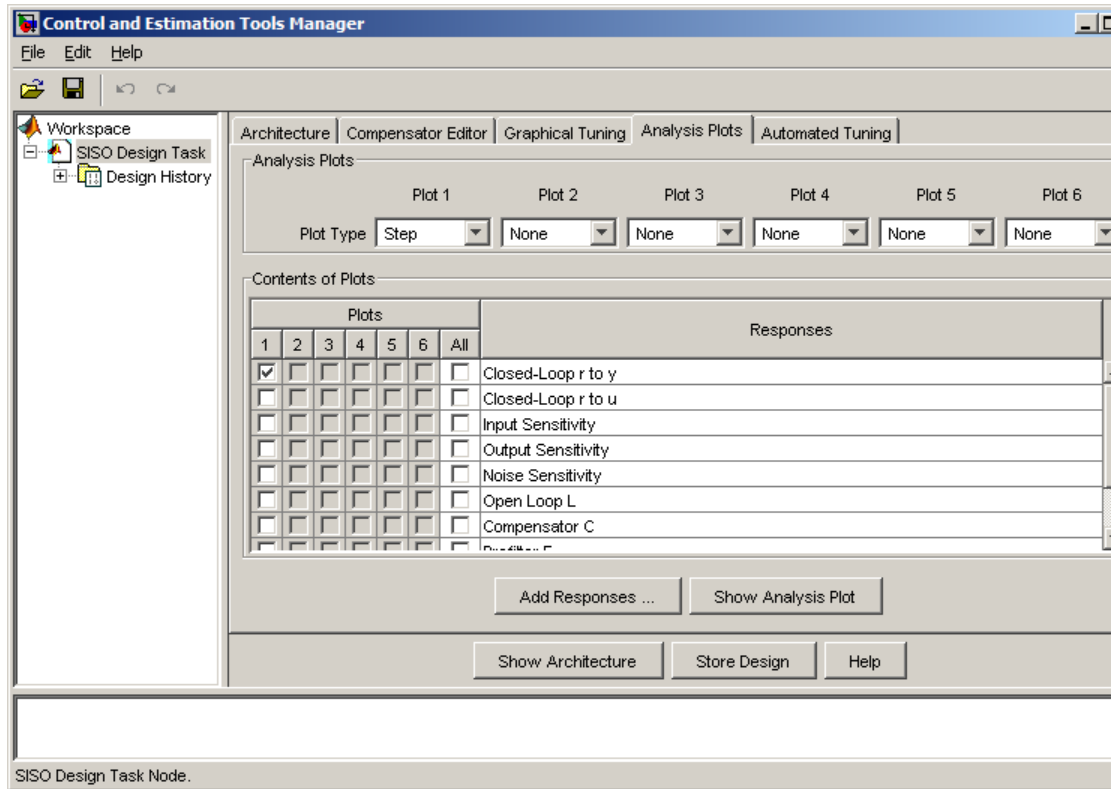

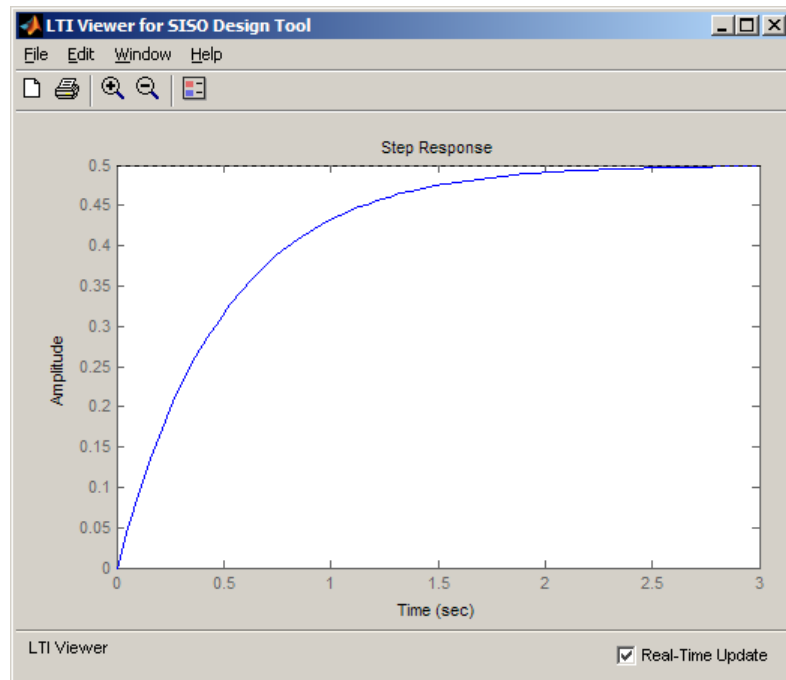

Now add the time domain design requirements to the step response plot by right clicking on the axis and selecting the **Design Requirements** -> **New** menu item. We will use the "Step response bounds" design requirement type to specify the rise time, settling time and overshoot requirements.

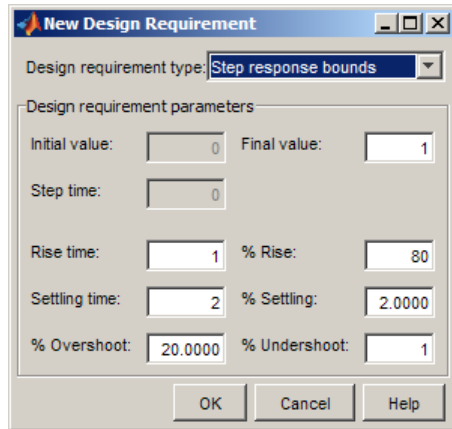

We can now use this time response with its requirements to view the performance of the compensator design.

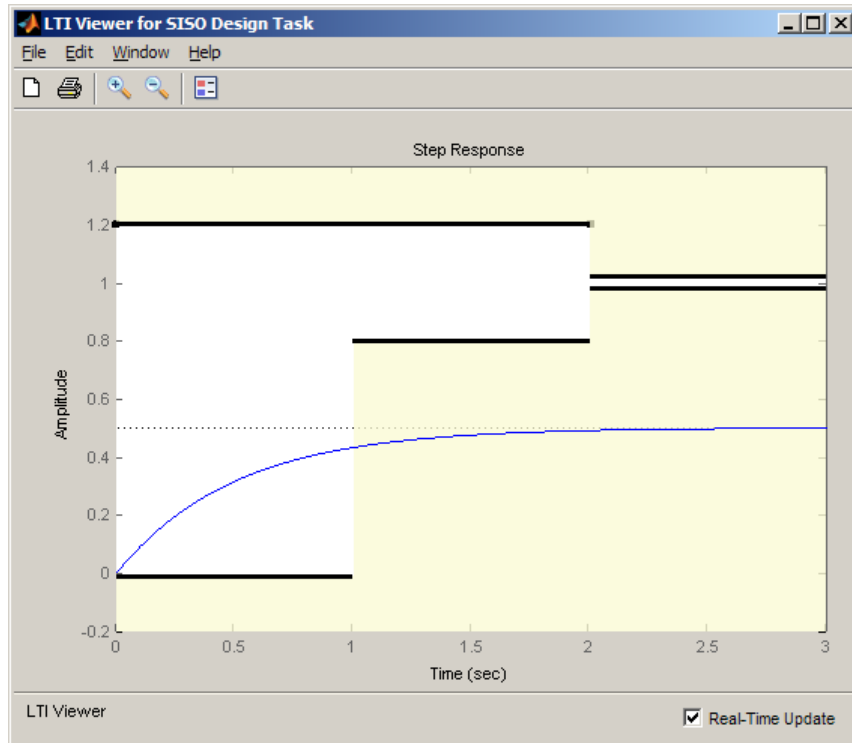

To specify the frequency domain crossover requirement, right click the bode axis in the SISO Design window and select the **Design Requirement->New** menu item and specify an upper gain limit.

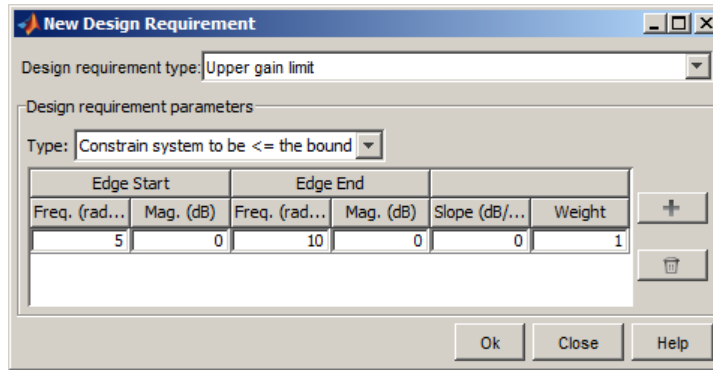

Now that the problem has been set up we will begin to design the compensator to satisfy the problem specifications.

Tuning Compensators

Compensators can be manually tuned from the graphical editors or the **Compensator Editor** tab of the CETM. For this example we will use the graphical editors to tune the compensator. To begin the design an integrator will be added to achieve zero steady state error to a step input. To add the integrator to the compensator use the right-click menu on the root-locus plot and select **Add Pole/Zero->Integrator**. To create a desirable shape for the root locus plot we will add a zero at approximately -2. To add the zero, use the right-click menu on the root-locus plot and select **Add Pole/Zero->Real Zero** menu item and then left-click at approximately -2 on the real axis of the root locus plot. Now in the bode plot adjust the open-loop gain by clicking and dragging the curve on the magnitude plot such that the cross-over and time domain constraints are satisfied.

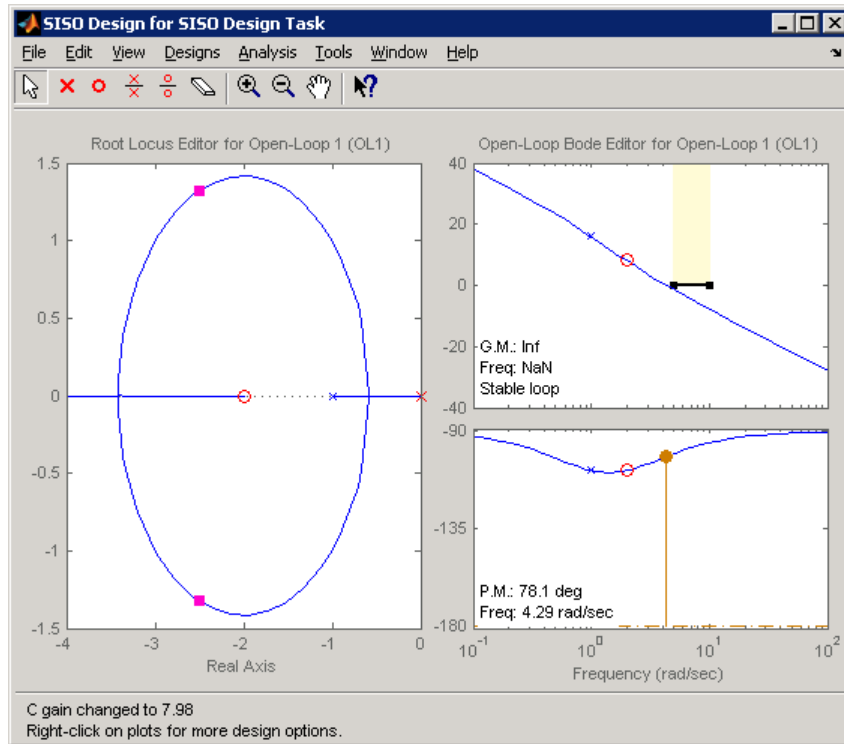

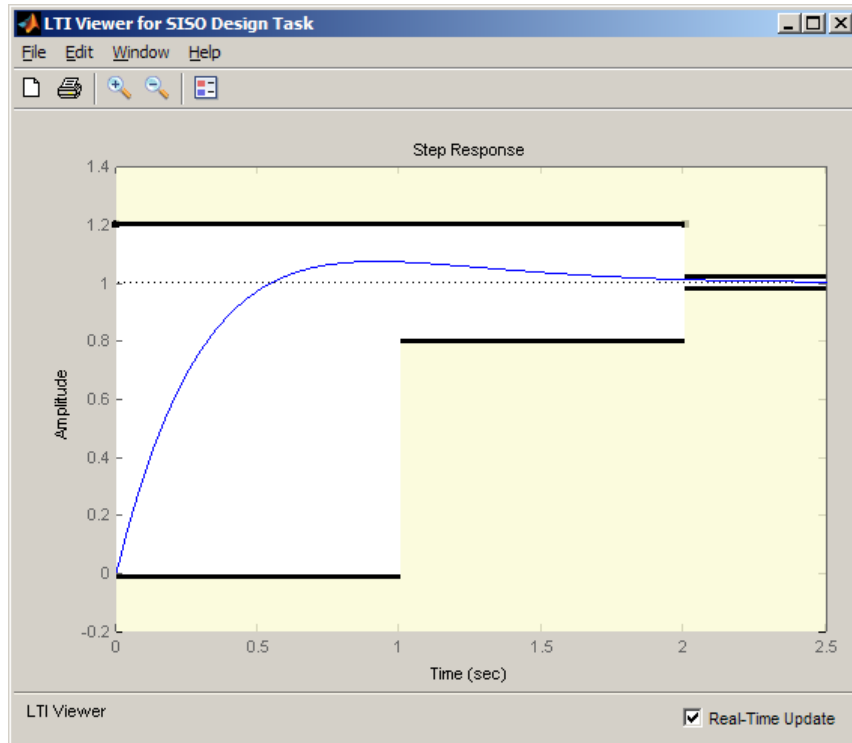

To view the compensator go to **Compensator Editor** tab. Note that the steps performed in the graphical tuning plots to tune the compensator can also be accomplished from this panel.

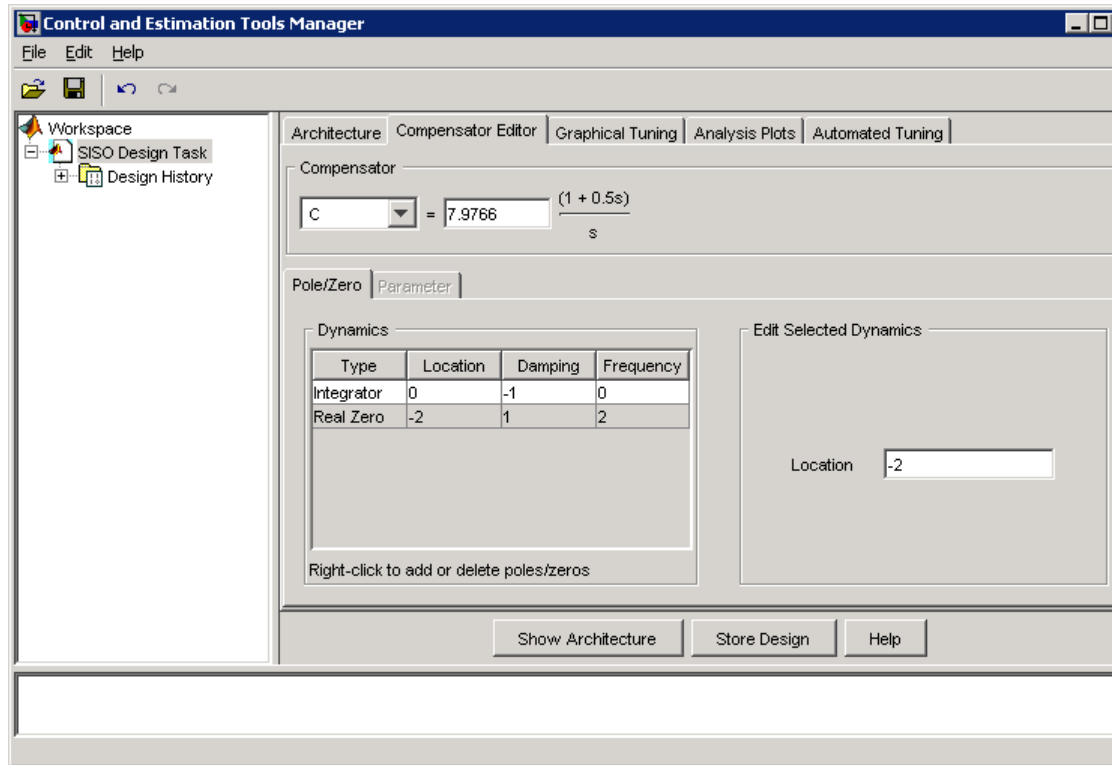

Automated Tuning of Compensators

In addition to the manual tuning interfaces, the SISO Design Tool also provides the following automated tuning algorithms:

- Use the **PID tuning**, **IMC tuning**, and **LQG synthesis** options in the **Automated Tuning** panel to compute initial parameters for the compensators based on tuning parameters such as closed-loop time constants. See the example "Automated Controller Design in the SISO Design Tool".
- Use the **Optimization based tuning** option in the **Automated Tuning** panel (requires Simulink Design Optimization) to tune the compensators

using both time and frequency domain design requirements. See the example "DC Motor Controller Tuning".

Summary

Using the SISO Design Tool we were able to successfully design a compensator such that all of the specified design requirements were satisfied. The tool facilitated the heuristic process of compensator design by providing an interactive and visual environment for

- Specifying the design requirements
- Tuning the compensator, and
- Evaluating the performance of the design.

Customization

- Chapter 11, “Preliminaries”
- Chapter 12, “Setting Toolbox Preferences”
- Chapter 13, “Setting Tool Preferences”
- Chapter 14, “Customizing Response Plot Properties”

Preliminaries

- “Terminology” on page 11-2
- “Property and Preferences Hierarchy” on page 11-3
- “Ways to Customize Plots” on page 11-5

Terminology

You can use the Control System Toolbox editors to set properties and preferences in the SISO Design Tool, the LTI Viewer, and in any response plots that you create from the MATLAB prompt.

Properties refer to settings that are specific to an individual response plot. This includes the following:

- Axes labels, and limits
- Data units and scales
- Plot styles, such as grids, fonts, and axes foreground colors
- Plot characteristics, such as rise time, peak response, and gain and phase margins

Preferences refers to properties that persist either

- Within a single session for a specific instance of an LTI Viewer or a SISO Design Tool
- Across Control System Toolbox sessions

The former are called *tool preferences*, the latter *toolbox preferences*.

Property and Preferences Hierarchy

You can use three graphical user interfaces (GUIs) to control over the visualization of time and frequency plots generated by the toolbox:

- Toolbox Preferences
- Tool Preferences
- Plot Properties

Preferences refer to global options that you can save from session to session or to any LTI Viewer or SISO Design Tool that you open during a single session. *Properties* are options that apply only to the current window. This section gives an overview of the three GUIs.

Although you can set plot properties in any response plot, you can use the Toolbox Preferences Editor to set properties for any response plot that you generate. This figure shows the inheritance hierarchy from toolbox preference to plot properties.

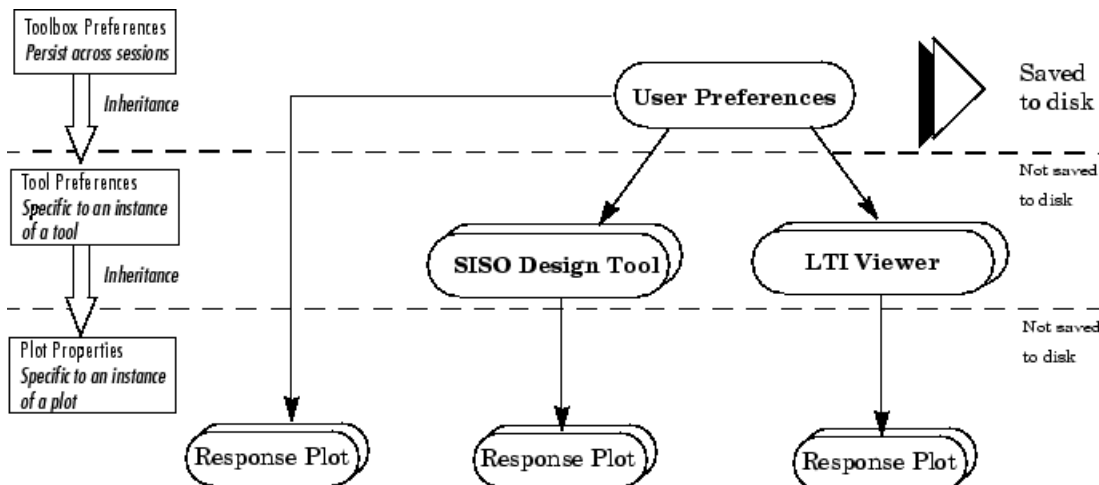

Preference and Property Inheritance Hierarchy

You can activate preference and plot editors by doing the following:

- Toolbox preferences — Select **Toolbox Preferences** under **File** in either the LTI Viewer or the SISO Design Tool.
- Tool preferences — Select **SISO Tool Preferences** under **Edit** for the SISO Design Tool and **Viewer Preferences** under **Edit** in the LTI Viewer.
- Plot properties — Double-click any Control System Toolbox response plot or select **Properties** from the right-click menus.

Ways to Customize Plots

You can customize your plots by changing plot properties. For example, you can change the plot units. The following table describes ways that you can customize plots.

To change plot properties of	For more information, see
A single plot, directly from the plot	<ul style="list-style-type: none"> • “Customizing Response Plots Using the Response Plots Property Editor” on page 14-3 and “Customizing Response Plots Using Plot Tools” on page 14-19 for response plots • “LTI Viewer Preferences Editor” on page 13-3 for LTI Viewer plots • “Graphical Tuning Window Preferences Editor” on page 13-9 for Graphical Tuning Window plots
A single plot or many plots, programmatically from the command line	“Customizing Response Plots from the Command Line” on page 14-23
All Control System Toolbox plots (changes apply globally to all plot types and persist from session to session)	“Toolbox Preferences Editor” on page 12-2

Setting Toolbox Preferences

- “Toolbox Preferences Editor” on page 12-2
- “Units Pane” on page 12-4
- “Style Pane” on page 12-7
- “Options Pane” on page 12-8
- “SISO Tool Pane” on page 12-9

Toolbox Preferences Editor

In this section...

“Overview of the Toolbox Preferences Editor” on page 12-2

“Opening the Toolbox Preferences Editor” on page 12-2

Overview of the Toolbox Preferences Editor

The Toolbox Preferences editor allows you to set plot preferences that will persist from session to session.

Opening the Toolbox Preferences Editor

To open the Toolbox Preferences editor, select **Toolbox Preferences** from the **File** menu of the LTI Viewer or the SISO Design Tool. Alternatively, you can type

```
ctrlpref
```

at the MATLAB prompt.

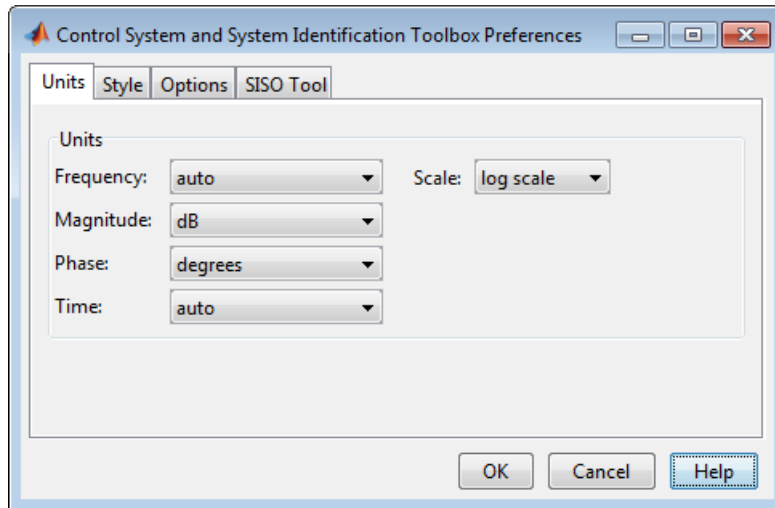

Control System Toolbox™ Preferences Editor

- “Units Pane” on page 12-4
- “Style Pane” on page 12-7
- “Options Pane” on page 12-8
- “SISO Tool Pane” on page 12-9

Units Pane

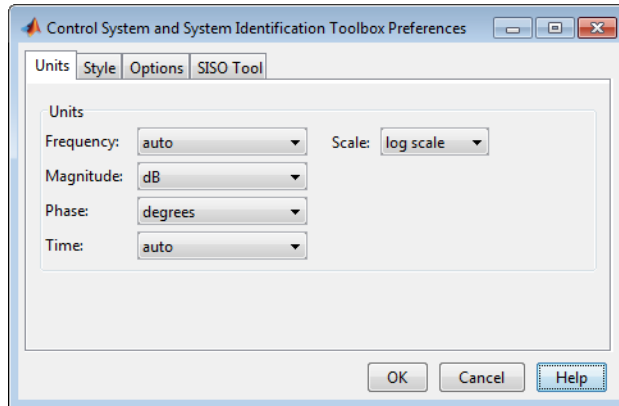

Use the **Units** pane to set preferences for the following:

- **Frequency**

The default `auto` option uses `rad/TimeUnit` as the frequency units relative to the system time units, where `TimeUnit` is the system time units specified in the `TimeUnit` property of the system on frequency-domain plots. For multiple systems with different time units, the units of the first system is used.

For the frequency axis, you can select logarithmic or linear scales.

Other Frequency Units Options

- 'Hz'
- 'rad/s'
- 'rpm'
- 'kHz'
- 'MHz'
- 'GHz'
- 'rad/nanosecond'
- 'rad/microsecond'

- 'rad/millisecond'
- 'rad/minute'
- 'rad/hour'
- 'rad/day'
- 'rad/week'
- 'rad/month'
- 'rad/year'
- 'cycles/nanosecond'
- 'cycles/microsecond'
- 'cycles/millisecond'
- 'cycles/hour'
- 'cycles/day'
- 'cycles/week'
- 'cycles/month'
- 'cycles/year'
- **Magnitude** — Decibels (dB) or absolute value (abs)
- **Phase** — Degrees or radians
- **Time**

The default auto option uses the time units specified in the `TimeUnit` property of the system on the time- and frequency-domain plots. For multiple systems with different time units, the units of the first system is used.

Other Time Units Options

- 'nanoseconds'
- 'microseconds'
- 'milliseconds'
- 'seconds'

- 'minutes'
- 'hours'
- 'days'
- 'weeks'
- 'months'
- 'years'

Style Pane

Use the **Style** pane to toggle grid visibility and set font preferences and axes foreground colors for all plots you create. This figure shows the Style pane.

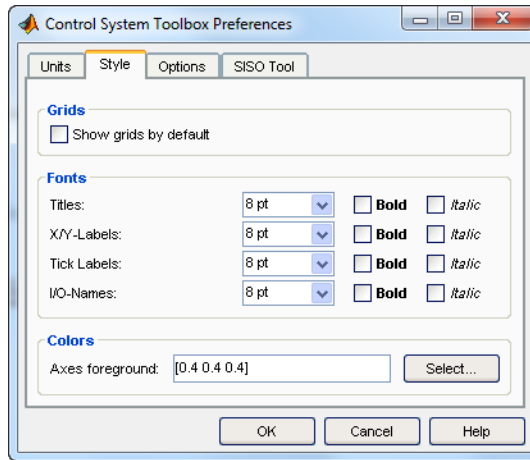

You have the following choices:

- **Grid** — Activate grids by default in new plots.
- **Fonts** — Set the font size, weight (bold), and angle (italic).
- **Colors** — Specify the color vector to use for the axes foreground, which includes the X-Y axes, grid lines, and tick labels. Use a three-element vector to represent red, green, and blue (RGB) values. Vector element values can range from 0 to 1.

If you do not want to specify RGB values numerically, click the **Select** button to open the **Select Colors** dialog box. See “Select colors” on page 13-13 for more information.

Options Pane

The Options pane has selections for time responses and frequency responses. This figure shows the Options pane with default settings.

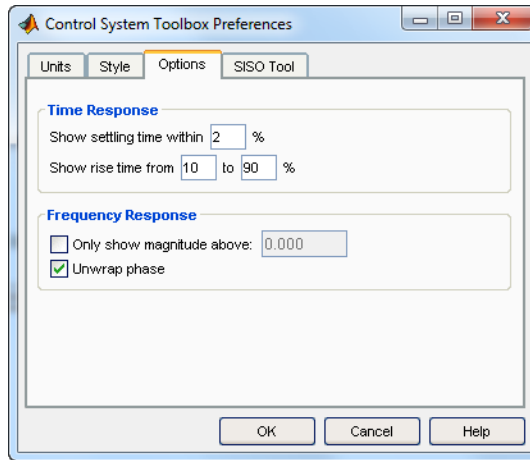

The following are the available options for the Options pane:

- **Time Response:**
 - Show settling time within $xx\%$ — You can set the threshold of the settling time calculation to any percentage from 0 to 100%. The default is 2%.
 - Specify rise time from $xx\%$ to $yy\%$ — The standard definition of rise time is the time it takes the signal to go from 10% to 90% of the final value. You can choose any percentages you like (from 0% to 100%), provided that the first value is smaller than the second.
- **Frequency Response:**
 - Only show magnitude above xx —Specify a lower limit for magnitude values in response plots so that you can focus on a region of interest.
 - Unwrap phase—By default, the phase is unwrapped. Wrap the phrase by clearing this box. If the phase is wrapped, all phase values are shifted such that their equivalent value displays in the range $[-180^\circ, 180^\circ)$.

SISO Tool Pane

The SISO Tool pane has settings for the SISO Design Tool. This figure shows the SISO Tool pane with default settings.

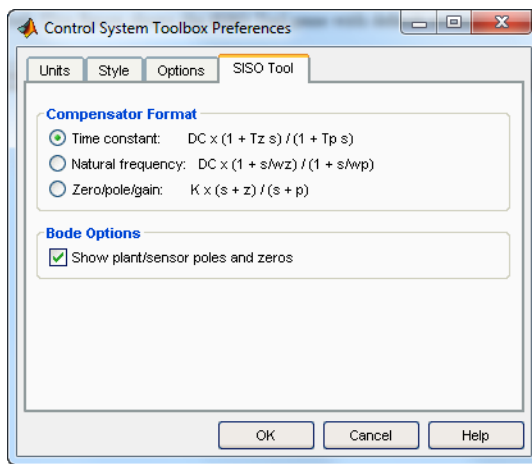

You can make the following selections:

- **Compensator Format** — Select the time constant, natural frequency, or zero/pole/gain format. The time constant format is a factorization of the compensator transfer function of the form

$$DC \times \frac{(1 + Tz_1 s)}{(1 + Tp_1 s)} \dots$$

where DC is compensator DC gain, Tz_1, Tz_2, \dots , are the zero time constants, and Tp_1, Tp_2, \dots , are the pole time constants.

The natural frequency format is

$$DC \times \frac{(1 + s/\omega_{z_1})}{(1 + s/\omega_{p_1})} \dots$$

where DC is compensator DC gain, ω_{z1} , and ω_{z2} , ... and ω_{p1} , ω_{p2} , ..., are the natural frequencies of the zeros and poles, respectively.

The zero/pole/gain format is

$$K \times \frac{(s + z_1)}{(s + p_1)}$$

where K is the overall compensator gain, and z_1, z_2, \dots and p_1, p_2, \dots , are the zero and pole locations, respectively.

- **Bode Options** — By default, the SISO Design Tool shows the plant and sensor poles and zeros as blue x's and o's, respectively. Clear this box to eliminate the plant's poles and zeros from the Bode plot. Note that the compensator poles and zeros (in red) will still appear.

Setting Tool Preferences

- “Introduction” on page 13-2
- “LTI Viewer Preferences Editor” on page 13-3
- “Graphical Tuning Window Preferences Editor” on page 13-9

Introduction

Both the LTI Viewer and the Graphical Tuning Window have Tool Preferences Editors. These editors comprise the middle layer of “Property and Preferences Hierarchy” on page 11-3.

Both editors allow you to set default characteristics for specific instances of LTI Viewers and Graphical Tuning windows. If you open a new instance of either, each defaults to the characteristics specified in the Toolbox Preferences editor.

LTI Viewer Preferences Editor

In this section...

“Opening the LTI Viewer Preference Editor” on page 13-3

“Units Pane” on page 13-4

“Style Pane” on page 13-6

“Options Pane” on page 13-7

“Parameters Pane” on page 13-8

Opening the LTI Viewer Preference Editor

Select **Viewer Preferences** under the **Edit** menu of the LTI Viewer to open the **LTI Viewer Preferences** editor, which is a tool for customizing various LTI Viewer properties, including units, fonts, and various other viewer characteristics. This figure shows the editor open to its first pane.

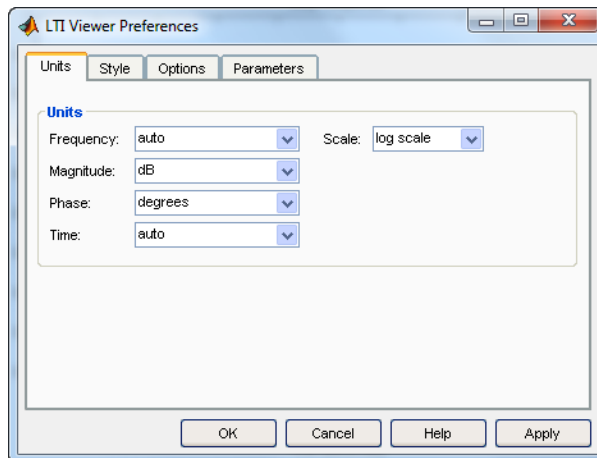

- “Units Pane” on page 13-4
- “Style Pane” on page 13-6
- “Options Pane” on page 13-7
- “Parameters Pane” on page 13-8

Units Pane

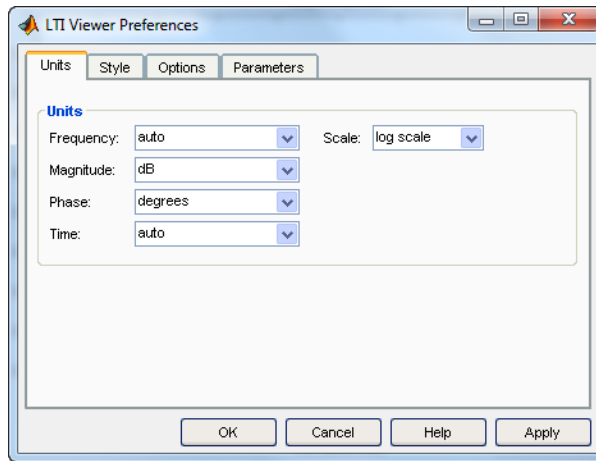

You can select the following on the **Units** pane:

- **Frequency**

The default auto option uses $\text{rad}/\text{TimeUnit}$ as the frequency units relative to the system time units, where `TimeUnit` is the system time units specified in the `TimeUnit` property of the system on frequency-domain plots. For multiple systems with different time units, the units of the first system is used.

For the frequency axis, you can select logarithmic or linear scales.

Other Frequency Units Options

- 'Hz'
- 'rad/s'
- 'rpm'
- 'kHz'
- 'MHz'
- 'GHz'
- 'rad/nanosecond'

- 'rad/microsecond'
- 'rad/millisecond'
- 'rad/minute'
- 'rad/hour'
- 'rad/day'
- 'rad/week'
- 'rad/month'
- 'rad/year'
- 'cycles/nanosecond'
- 'cycles/microsecond'
- 'cycles/millisecond'
- 'cycles/hour'
- 'cycles/day'
- 'cycles/week'
- 'cycles/month'
- 'cycles/year'
- **Magnitude** — Decibels (dB) or absolute value (abs)
- **Phase** — Degrees or radians
- **Time**

The default auto option uses the time units specified in the `TimeUnit` property of the system on the time- and frequency-domain plots. For multiple systems with different time units, the units of the first system is used.

Other Time Units Options

- 'nanoseconds'
- 'microseconds'
- 'milliseconds'

- 'seconds'
- 'minutes'
- 'hours'
- 'days'
- 'weeks'
- 'months'
- 'years'

Style Pane

Use the **Style** pane to toggle grid visibility and set font preferences and axes foreground colors for all plots in the LTI Viewer. This figure shows the Style pane.

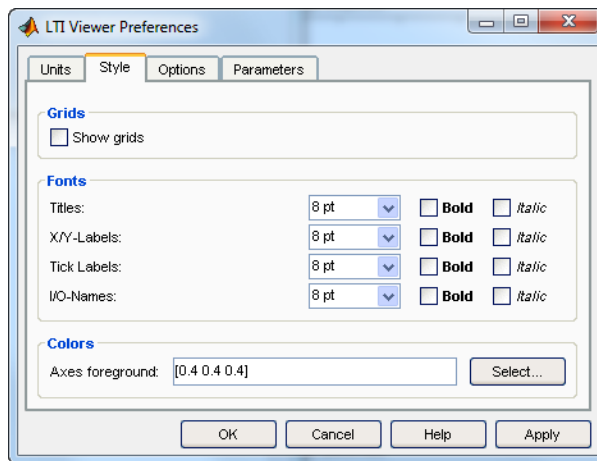

You have the following choices:

- **Grid** — Activate grids for all plots in the LTI Viewer
- **Fonts** — Set the font size, weight (bold), and angle (italic)
- **Colors** — Specify the color vector to use for the axes foreground, which includes the X-Y axes, grid lines, and tick labels. Use a three-element

vector to represent red, green, and blue (RGB) values. Vector element values can range from 0 to 1.

- If you do not want to specify the RGB values numerically, press the **Select** button to open the **Select Colors** window. See “Select colors” on page 13-13 for more information.

Options Pane

The Options pane has selections for time responses and frequency responses.

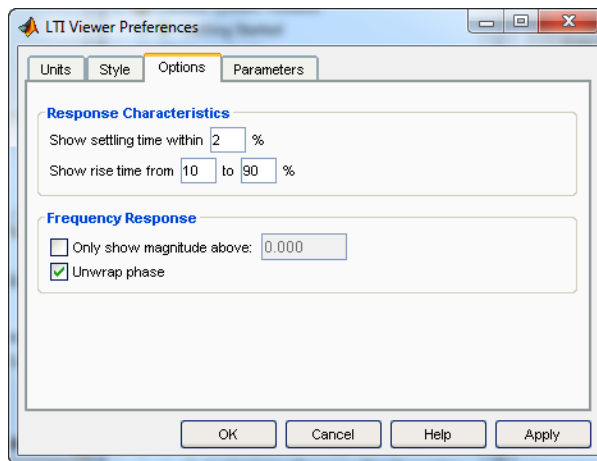

The following choices are available:

- **Time Response:**
 - Show settling time within $xx\%$ — You can set the threshold of the settling time calculation to any percentage from 0 to 100%. The default is 2%.
 - Specify rise time from $xx\%$ to $yy\%$ — The standard definition of rise time is the time it takes the signal to go from 10% to 90% of the final value. You can choose any percentages you like (from 0% to 100%), provided that the first value is smaller than the second.
- **Frequency Response:**
 - Only show magnitude above xx —Specify a lower limit for magnitude values in response plots so that you can focus on a region of interest.

- Unwrap phase—By default, the phase is unwrapped. Wrap the phase by clearing this box. If the phase is wrapped, all phase values are shifted such that their equivalent value displays in the range $[-180^\circ, 180^\circ)$.

Parameters Pane

Use the **Parameters** pane, shown below, to specify input vectors for time and frequency simulation.

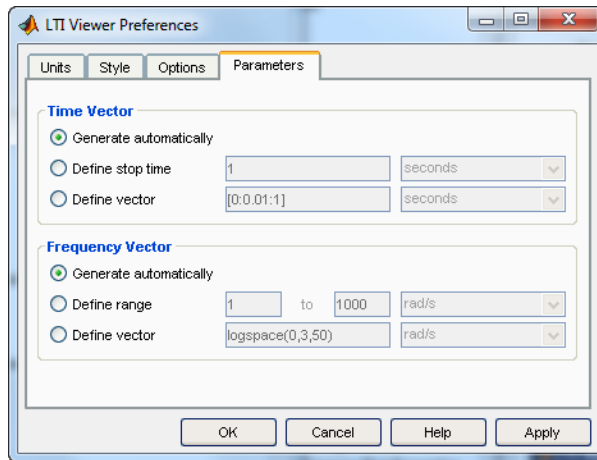

The defaults are to generate time and frequency vectors for your plots automatically. You can, however, override the defaults as follows:

- **Time Vector:**
 - Define stop time — Specify the final time value for your simulation
 - Define vector — Specify the time vector manually using equal-sized time steps
- **Frequency Vector:**
 - Define range — Specify the bandwidth of your response. Whether it's in rad/sec or Hz depends on the selection you made in the Units pane.
 - Define vector — Specify the vector for your frequency values. Any real, positive, strictly monotonically increasing vector is valid.

Graphical Tuning Window Preferences Editor

In this section...

“Opening the Graphical Tuning Window Preferences Editor” on page 13-9

“Units Pane” on page 13-10

“Time Delays Pane” on page 13-11

“Style Pane” on page 13-12

“Options Pane” on page 13-15

“Line Colors Pane” on page 13-16

Opening the Graphical Tuning Window Preferences Editor

To open the **SISO Tool Preferences** editor, select **SISO Tool Preferences** from the **Edit** menu of the Graphical Tuning window. This window opens.

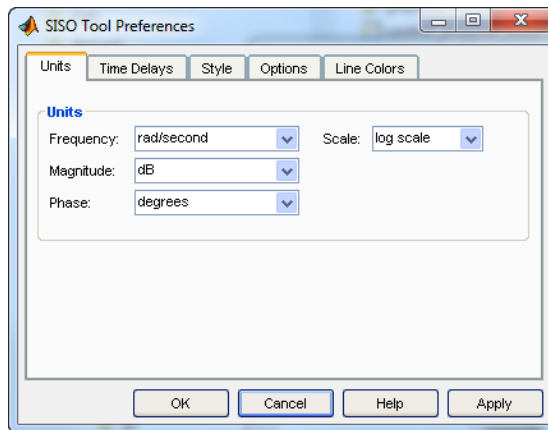

Units Pane

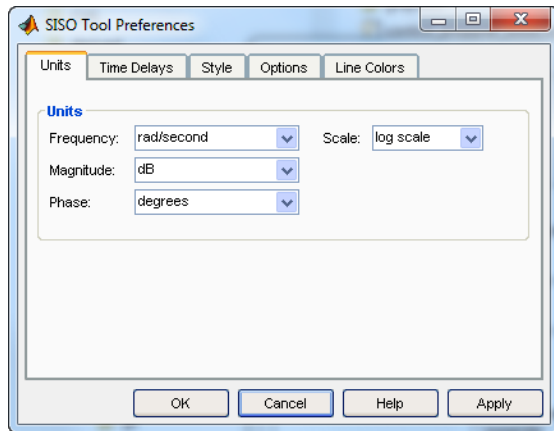

The **Units** pane has settings for the following units:

- **Frequency**

The default units are rad/second.

Other Frequency Units Options

- ' Hz '
- ' rad / s '
- ' rpm '
- ' kHz '
- ' MHz '
- ' GHz '
- ' rad/nanosecond '
- ' rad/microsecond '
- ' rad/millisecond '
- ' rad/minute '
- ' rad/hour '
- ' rad/day '

- 'rad/week'
 - 'rad/month'
 - 'rad/year'
 - 'cycles/nanosecond'
 - 'cycles/microsecond'
 - 'cycles/millisecond'
 - 'cycles/hour'
 - 'cycles/day'
 - 'cycles/week'
 - 'cycles/month'
 - 'cycles/year'
- **Magnitude** — Decibels (dB) or absolute value (abs)
 - **Phase** — Degrees or radians

For frequency and magnitude axes, you can select logarithmic or linear scales.

Time Delays Pane

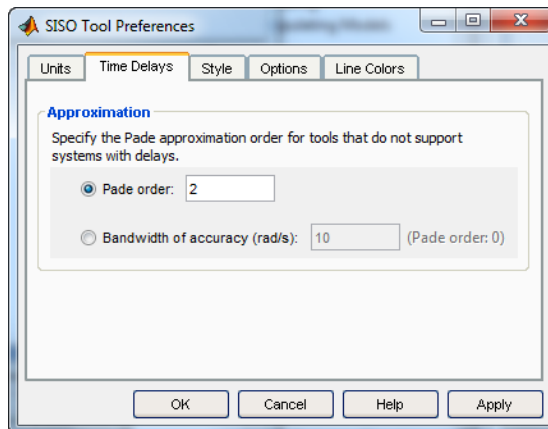

In the Time Delays pane, specify the order for Padé approximations of delays in your system as either:

- Actual Padé order
- Bandwidth of accuracy (rad/s) — The highest frequency at which the approximated response matches the actual system. The software computes and displays the corresponding Padé order.

The following compensator design tools do not support systems with exact time delays. If your system has exact continuous-time delays, these tools automatically compute a Padé approximation of the delays. In this case, you receive a notification.

- Root locus
- Pole-zero
- PID automated tuning
- IMC automated tuning
- LQG automated tuning
- Loop shaping automated tuning

Tip To determine if a certain Padé order gives a good approximation of your system, use the `pade` command to approximate your system. Then, compare a plot of the two systems using the `bode` command.

Style Pane

Use the Style pane to toggle grid visibility and set font preferences and axes foreground colors for all plots in the Graphical Tuning Window. This figure shows the Style pane.

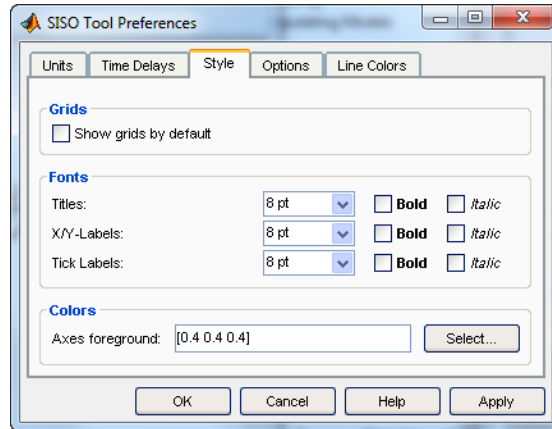

Grids Panel

Select the box to activate grids for all plots in the GRAPHICAL Tuning Window

Fonts Panel

Set the font size, weight (bold), and angle (italic) by using the menus and check boxes.

Colors Panel

Specify the color vector to use for the axes foreground, which includes the X-Y axes, grid lines, and tick labels. Use a three-element vector to represent red, green, and blue (RGB) values. Vector element values can range from 0 to 1.

Select colors. Click the **Select** button to open the Select Color window for the axes foreground.

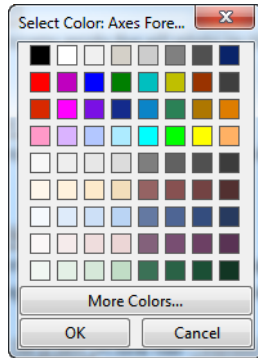

You can use this window to choose axes foreground colors without having to set RGB (red-green-blue) values numerically. To make your selections, click on the colored rectangles and press OK. If you want a broader range of colors, click the **More Colors** button. This opens the More Colors window, as shown in the following figure.

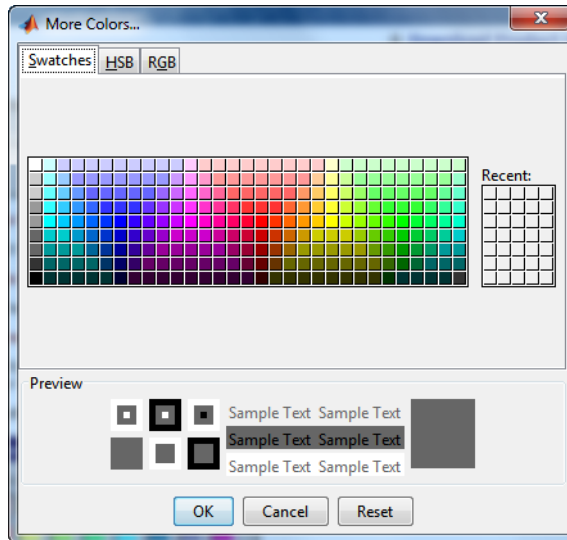

Click on the array of color swatches to select a color. Alternatively, click the HSB tab to use the Hue Saturation Brightness (HSB) color picker. Or, click the RGB tab to enter numeric RGB values.

When you select a color, the **Preview** section of the window changes to preview your selection. Click **OK** to accept the choice. Click **Reset** to reset the selection.

Options Pane

The Options pane, shown below, has selections for compensator format and Bode diagrams.

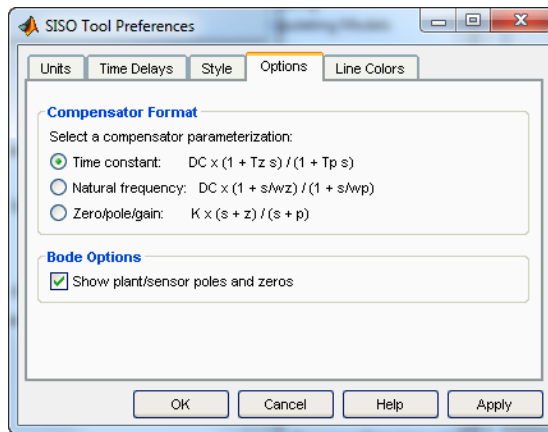

You can make the following selections:

- **Compensator Format** — Select the time constant, natural frequency, or zero/pole/gain format. The time constant format is a factorization of the compensator transfer function of the form

$$DC \times \frac{(1 + T_{z_1}s)}{(1 + T_{p_1}s)} \dots$$

where DC is compensator DC gain, T_{z_1}, T_{z_2}, \dots , are the zero time constants, and T_{p_1}, T_{p_2}, \dots , are the pole time constants.

The natural frequency format is

$$DC \times \frac{(1 + s/\omega_{z_1}) \dots}{(1 + s/\omega_{p_1}) \dots}$$

where DC is compensator DC gain, ω_{z_1} , and ω_{z_2}, \dots and $\omega_{p_1}, \omega_{p_2}, \dots$, are the natural frequencies of the zeros and poles, respectively.

The zero/pole/gain format is

$$K \times \frac{(s + z_1)}{(s + p_1)}$$

where K is the overall compensator gain, and z_1, z_2, \dots and p_1, p_2, \dots , are the zero and pole locations, respectively.

- **Bode Options** — By default, the GRAPHICAL Tuning Window shows the plant and sensor poles and zeros as blue x's and o's, respectively. Clear this check box to eliminate the plant's poles and zeros from the Bode plot. Note that the compensator poles and zeros (in red) will still appear.

Line Colors Pane

The Line Colors pane, shown below, has selections for specify the colors of the lines in the response plots of the Graphical Tuning Window.

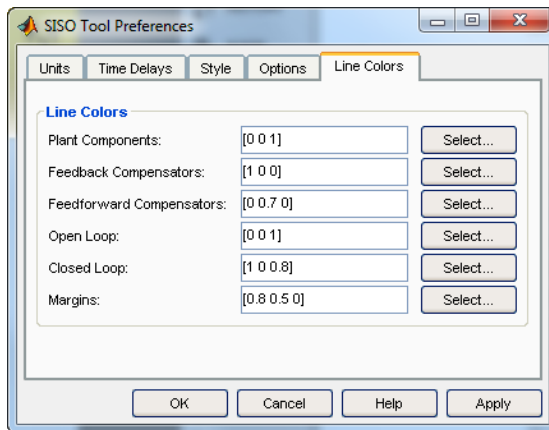

To change the colors of plot lines associated with parts of your model, specify a three-element vector to represent red, green, and blue (RGB) values. Vector element values can range from 0 to 1.

If you do not want to specify the RGB values numerically, click the **Select** button to open the Select Color window. See “Select colors” on page 13-13 for more information.

Customizing Response Plot Properties

- “Introduction” on page 14-2
- “Customizing Response Plots Using the Response Plots Property Editor” on page 14-3
- “Customizing Response Plots Using Plot Tools” on page 14-19
- “Customizing Response Plots from the Command Line” on page 14-23
- “Customizing Plots Inside the SISO Design Tool” on page 14-48

Introduction

The lowest level of the “Property and Preferences Hierarchy” on page 11-3 is setting response plot properties. This means that any property you set for a given plot will only affect that plot.

Customizing Response Plots Using the Response Plots Property Editor

In this section...

“Opening the Property Editor” on page 14-3

“Overview of Response Plots Property Editor” on page 14-4

“Labels Pane” on page 14-6

“Limits Pane” on page 14-6

“Units Pane” on page 14-7

“Style Pane” on page 14-16

“Options Pane” on page 14-17

“Editing Subplots Using the Property Editor” on page 14-18

Opening the Property Editor

After you create a response plot, there are two ways to open the Property Editor:

- Double-click in the plot region
- Select **Properties** from the right-click menu

Before looking at the Property Editor, open a step response plot using these commands.

```
load ltiexamples
step(sys_dc)
```

This creates a step plot. Select **Properties** from the right-click menu. Note that when you open the **Property Editor**, a set of black squares appear around the step response, as this figure shows:

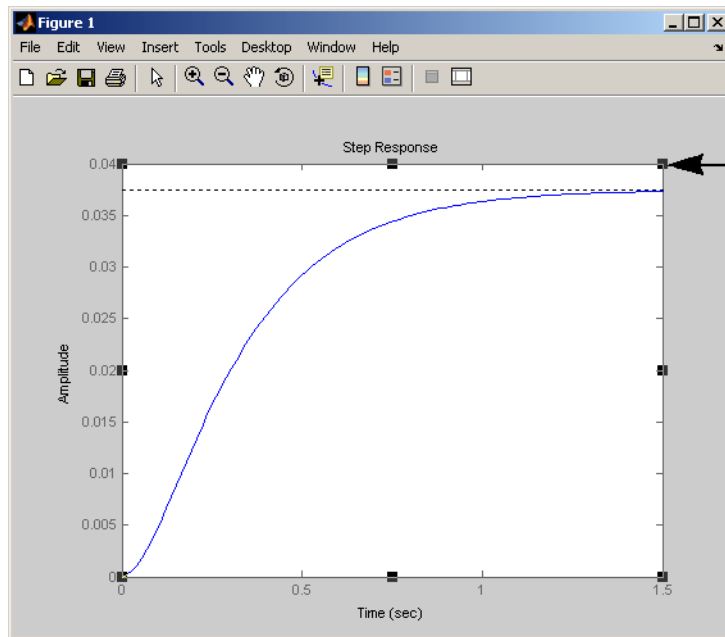

The black squares surrounding the plot indicate that the Property Editor is active for this plot.

SISO System Step Response

Overview of Response Plots Property Editor

This figure shows the Property Editor dialog box for a step response.

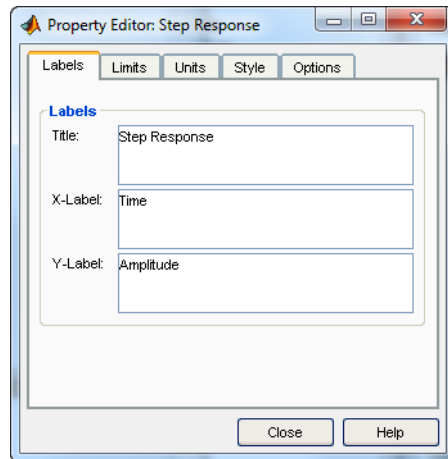

The Property Editor for Step Response

In general, you can change the following properties of response plots. Note that only the **Labels** and **Limits** panes are available when using the **Property Editor** with Simulink Design Optimization™ software.

- Titles and X- and Y-labels in the **Labels** pane.
- Numerical ranges of the X and Y axes in the **Limits** pane.
- Units where applicable (e.g., rad/s to Hertz) in the **Units** pane.

If you cannot customize units, as is the case with step responses, the Property Editor will display that no units are available for the selected plot.

- Styles in the **Styles** pane.

You can show a grid, adjust font properties, such as font size, bold and italics, and change the axes foreground color

- Change options where applicable in the **Options** pane.

These include peak response, settling time, phase and gain margins, etc. Plot options change with each plot response type. The Property Editor displays only the options that make sense for the selected response plot.

For example, phase and gain margins are not available for step responses.

As you make changes in the Property Editor, they display immediately in the response plot. Conversely, if you make changes in a plot using right-click

menus, the Property Editor for that plot automatically updates. The Property Editor and its associated plot are dynamically linked.

Labels Pane

To specify new text for plot titles and axis labels, type the new string in the field next to the label you want to change. Note that the label changes immediately as you type, so you can see how the new text looks as you are typing.

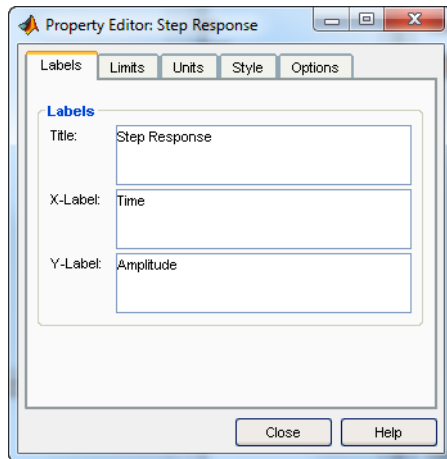

Limits Pane

Default values for the axes limits make sure that the maximum and minimum x and y values are displayed. If you want to override the default settings, change the values in the Limits fields. The **Auto-Scale** box automatically clears if you click a different field. The new limits appear immediately in the response plot.

To reestablish the default values, select the **Auto-Scale** box again.

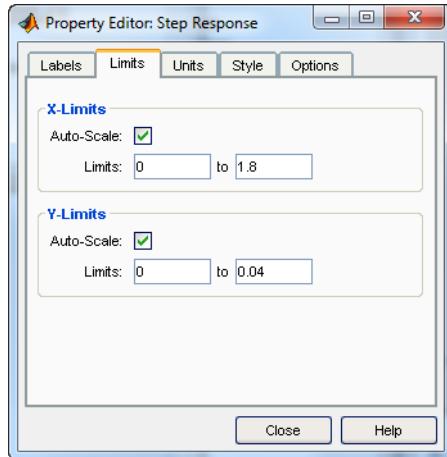

Units Pane

You can use the **Units** pane to change units in your response plot. The contents of this pane depend on the response plot associated with the editor.

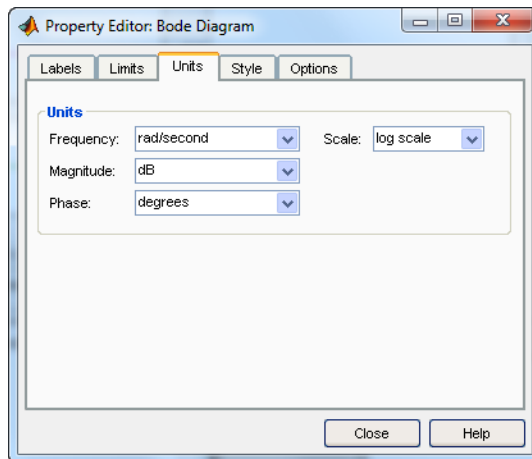

The following table lists the options available for the response objects. Use the menus to toggle between units.

Optional Unit Conversions for Response Plots

Response Plot	Unit Conversions
Bode and Bode Magnitude	<ul style="list-style-type: none"> • Frequency <p>By default, shows rad/TimeUnit where TimeUnit is the system time units specified in the TimeUnit property of the input system.</p> <p>Frequency Units Options</p> <ul style="list-style-type: none"> - 'Hz' - 'rad/s' - 'rpm' - 'kHz' - 'MHz' - 'GHz' - 'rad/nanosecond' - 'rad/microsecond' - 'rad/millisecond' - 'rad/minute' - 'rad/hour' - 'rad/day' - 'rad/week' - 'rad/month' - 'rad/year' - 'cycles/nanosecond' - 'cycles/microsecond' - 'cycles/millisecond' - 'cycles/hour' - 'cycles/day'

Optional Unit Conversions for Response Plots (Continued)

Response Plot	Unit Conversions
	<ul style="list-style-type: none"> - 'cycles/week' - 'cycles/month' - 'cycles/year' • Frequency scale is logarithmic or linear. • Magnitude in decibels (dB) or the absolute value • Phase in degrees or radians
Impulse	<ul style="list-style-type: none"> • Time. <p>By default, shows the system time units specified in the TimeUnit property of the input system.</p> <p>Time Units Options</p> <ul style="list-style-type: none"> - 'nanoseconds' - 'microseconds' - 'milliseconds' - 'seconds' - 'minutes' - 'hours' - 'days' - 'weeks' - 'months' - 'years'

Optional Unit Conversions for Response Plots (Continued)

Response Plot	Unit Conversions
Nichols Chart	<ul style="list-style-type: none"> • Frequency <p>By default, shows rad/TimeUnit where TimeUnit is the system time units specified in the TimeUnit property of the input system.</p> <p>Frequency Units Options</p> <ul style="list-style-type: none"> - 'Hz' - 'rad/s' - 'rpm' - 'kHz' - 'MHz' - 'GHz' - 'rad/nanosecond' - 'rad/microsecond' - 'rad/millisecond' - 'rad/minute' - 'rad/hour' - 'rad/day' - 'rad/week' - 'rad/month' - 'rad/year' - 'cycles/nanosecond' - 'cycles/microsecond' - 'cycles/millisecond' - 'cycles/hour' - 'cycles/day'

Optional Unit Conversions for Response Plots (Continued)

Response Plot	Unit Conversions
	<ul style="list-style-type: none"> - 'cycles/week' - 'cycles/month' - 'cycles/year' • Phase in degrees or radians
Nyquist Diagram	<ul style="list-style-type: none"> • Frequency <p>By default, shows rad/TimeUnit where TimeUnit is the system time units specified in the TimeUnit property of the input system.</p> <p>Frequency Units Options</p> <ul style="list-style-type: none"> - 'Hz' - 'rad/s' - 'rpm' - 'kHz' - 'MHz' - 'GHz' - 'rad/nanosecond' - 'rad/microsecond' - 'rad/millisecond' - 'rad/minute' - 'rad/hour' - 'rad/day' - 'rad/week' - 'rad/month' - 'rad/year'

Optional Unit Conversions for Response Plots (Continued)

Response Plot	Unit Conversions
	<ul style="list-style-type: none"> - 'cycles/nanosecond' - 'cycles/microsecond' - 'cycles/millisecond' - 'cycles/hour' - 'cycles/day' - 'cycles/week' - 'cycles/month' - 'cycles/year'
Pole/Zero Map	<ul style="list-style-type: none"> • Time. By default, shows the system time units specified in the TimeUnit property of the input system. <p>Time Units Options</p> <ul style="list-style-type: none"> - 'nanoseconds' - 'microseconds' - 'milliseconds' - 'seconds' - 'minutes' - 'hours' - 'days' - 'weeks' - 'months' - 'years' <ul style="list-style-type: none"> • Frequency

Optional Unit Conversions for Response Plots (Continued)

Response Plot	Unit Conversions
	<p>By default, shows rad/TimeUnit where TimeUnit is the system time units specified in the TimeUnit property of the input system.</p> <p>Frequency Units Options</p> <ul style="list-style-type: none"> - 'Hz' - 'rad/s' - 'rpm' - 'kHz' - 'MHz' - 'GHz' - 'rad/nanosecond' - 'rad/microsecond' - 'rad/millisecond' - 'rad/minute' - 'rad/hour' - 'rad/day' - 'rad/week' - 'rad/month' - 'rad/year' - 'cycles/nanosecond' - 'cycles/microsecond' - 'cycles/millisecond' - 'cycles/hour' - 'cycles/day'

Optional Unit Conversions for Response Plots (Continued)

Response Plot	Unit Conversions
	<ul style="list-style-type: none"> - 'cycles/week' - 'cycles/month' - 'cycles/year'
Singular Values	<ul style="list-style-type: none"> • Frequency <p>By default, shows rad/TimeUnit where TimeUnit is the system time units specified in the TimeUnit property of the input system.</p> <p>Frequency Units Options</p> <ul style="list-style-type: none"> - 'Hz' - 'rad/s' - 'rpm' - 'kHz' - 'MHz' - 'GHz' - 'rad/nanosecond' - 'rad/microsecond' - 'rad/millisecond' - 'rad/minute' - 'rad/hour' - 'rad/day' - 'rad/week' - 'rad/month' - 'rad/year' - 'cycles/nanosecond'

Optional Unit Conversions for Response Plots (Continued)

Response Plot	Unit Conversions
	<ul style="list-style-type: none"> - 'cycles/microsecond' - 'cycles/millisecond' - 'cycles/hour' - 'cycles/day' - 'cycles/week' - 'cycles/month' - 'cycles/year' • Frequency scale is logarithmic or linear. • Magnitude in decibels or the absolute value using logarithmic or linear scale
Step	<ul style="list-style-type: none"> • Time. <p>By default, shows the system time units specified in the TimeUnit property of the input system.</p> <p>Time Units Options</p> <ul style="list-style-type: none"> - 'nanoseconds' - 'microseconds' - 'milliseconds' - 'seconds' - 'minutes' - 'hours' - 'days' - 'weeks' - 'months' - 'years'

Style Pane

Use the Style pane to toggle grid visibility and set font preferences and axes foreground colors for response plots.

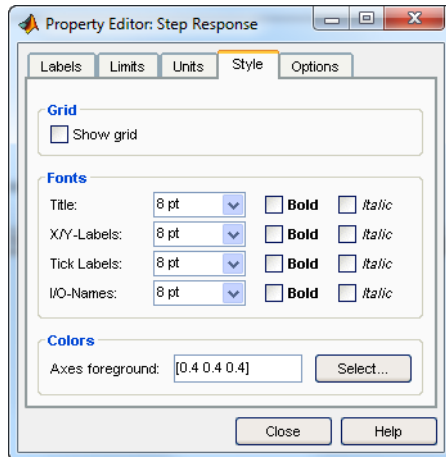

You have the following choices:

- **Grid** — Activate grids by default in new plots.
- **Fonts** — Set the font size, weight (bold), and angle (italic) for fonts used in response plot titles, X/Y-labels, tick labels, and I/O-names.
- **Colors** — Specify the color vector to use for the axes foreground, which includes the X-Y axes, grid lines, and tick labels. Use a three-element vector to represent red, green, and blue (RGB) values. Vector element values can range from 0 to 1.

If you do not want to specify RGB values numerically, click the **Select** button to open the **Select Color** dialog box. See “Select colors” on page 13-13 for more information.

Options Pane

The **Options** pane allows you to customize response characteristics for plots. Each response plot has its own set of characteristics and optional settings; the table below lists them. Use the check boxes to activate the feature and the fields to specify rise or settling time percentages.

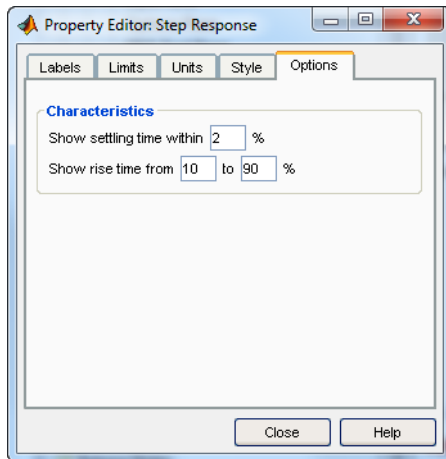

Response Characteristic Options for Response Plots

Plot	Customizable Feature
Bode Diagram and Bode Magnitude	Select lower magnitude limit Adjust phase offsets to keep phase close to a particular value, within a range of $\pm 180^\circ$, at a given frequency. Unwrap phase (default is unwrapped)
Impulse	Show settling time within $xx\%$ (specify the percentage)

Response Characteristic Options for Response Plots (Continued)

Plot	Customizable Feature
Nichols Chart	Select lower magnitude limit Adjust phase offsets to keep phase close to a particular value, within a range of $\pm 180^\circ$, at a given frequency. Unwrap phase (default is unwrapped)
Nyquist Diagram	None
Pole/Zero Map	None
Sigma	None
Step	Show settling time within <i>xx</i> % (specify the percentage) Show rise time from <i>xx</i> to <i>yy</i> % (specify the percentages)

Editing Subplots Using the Property Editor

If you create more than one plot in a single figure window, you can edit each plot individually. For example, the following code creates a figure with two plots, a step and an impulse response with two randomly selected systems:

```
subplot(2,1,1)
step(rss(2,1))
subplot(2,1,2)
impulse(rss(1,1))
```

After the figure window appears, double-click in the upper (step response) plot to activate the **Property Editor**. You will see a set of small black squares appear around the step response, indicating that it is the active plot for the editor. To switch to the lower (impulse response) plot, just click once in the impulse response plot region. The set of black squares switches to the impulse response, and the **Property Editor** updates as well.

Customizing Response Plots Using Plot Tools

In this section...

“Properties You Can Customize Using Plot Tools” on page 14-19

“Opening and Working with Plot Tools” on page 14-20

“Example of Changing Line Color Using Plot Tools” on page 14-20

Properties You Can Customize Using Plot Tools

The following table shows the plot properties you can customize using plot tools.

For...	You can customize the following properties:
Responses	<ul style="list-style-type: none"> • System name • Line color • Line style • Line width • Marker type <p>For SISO systems, these changes apply to a single plot line or an array of plot lines representing the system on one axis. For MIMO systems, these changes apply to all of the plotted lines representing the system on multiple axis.</p>
Plot axes	<ul style="list-style-type: none"> • Title • X-label • Y-label
Figures	<ul style="list-style-type: none"> • Figure name • Colormap • Figure color

Note To make other changes to response plots, see “Customizing Response Plots Using the Response Plots Property Editor” on page 14-3 and “Customizing Response Plots from the Command Line” on page 14-23.

Opening and Working with Plot Tools

See the following documentation for information about how to open and work with Plot Tools and the Plot Tools Property Editor:

- “Working in Plot Edit Mode” in the MATLAB documentation.
- “The Property Editor” in the MATLAB documentation.

Example of Changing Line Color Using Plot Tools

To change the line color of a MIMO system plot:

- 1** Create a step response plot of a MIMO system by typing

```
sys_mimo=rss(3,3,3);  
stepplot(sys_mimo)
```

- 2** In the figure window, select **View > Property Editor**.

This action opens the Plot Tools Property Editor.

- 3** Click the plot line in any of the nine axis.

This action selects the response for the `sys_mimo` system and updates the Plot Tools Property Editor to show the available editable properties for the response.

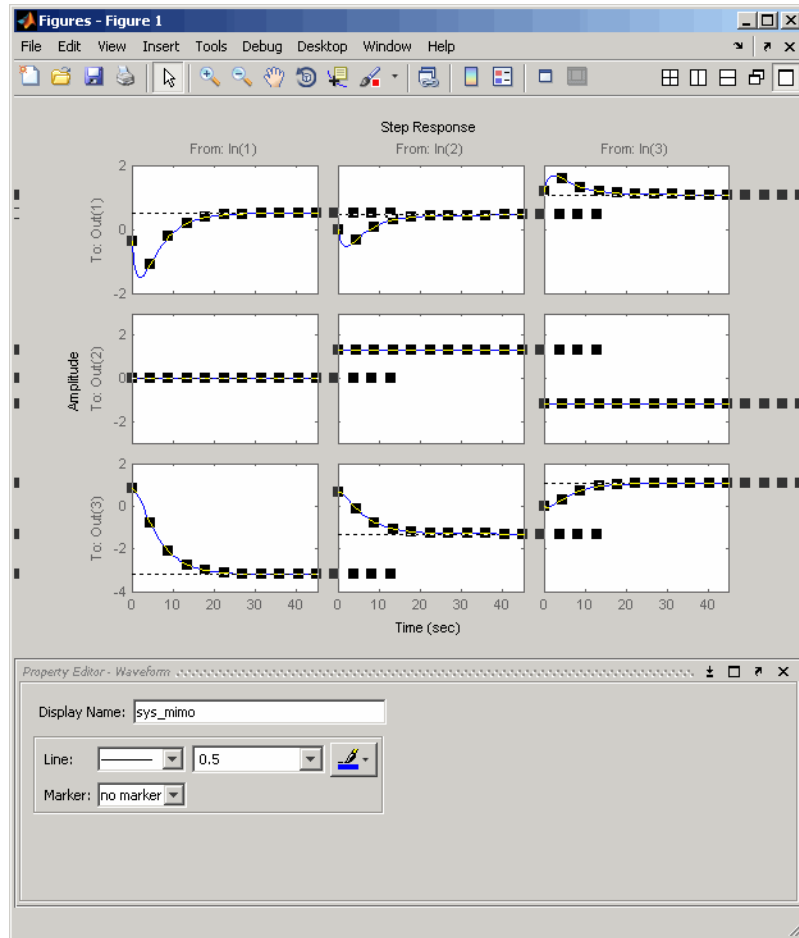

Note The Plot Tools Property Editor applies changes to the response of the MIMO system. Any change you make applies to all of the plotted lines in the figure.

Tip You can also change the properties of the response using the right-click menu while in plot edit mode.

4 In the **Property Editor – Waveform** pane, select the color red.

This action changes the color of the response that represents the MIMO system to red.

Customizing Response Plots from the Command Line

In this section...

- “Overview of Customizing Plots from the Command Line” on page 14-23
- “Obtaining Plot Handles” on page 14-26
- “Obtaining Plot Options Handles” on page 14-27
- “Examples of Customizing Plots from the Command Line” on page 14-30
- “Properties and Values Reference” on page 14-33
- “Property Organization Reference” on page 14-47

Overview of Customizing Plots from the Command Line

- “When to Customize Plots from the Command Line” on page 14-23
- “How to Customize Plots from the Command Line” on page 14-23
- “Example of Changing Bode Plot Units from the Command Line” on page 14-25

When to Customize Plots from the Command Line

You can customize any response plot from the command line. The command line is the most efficient way to customize a large number of plots. For example, if you have a batch job that produces many plots, you can change the x -axis units automatically for all the plot with just a few lines of code.

How to Customize Plots from the Command Line

You can use the Control System Toolbox application program interface (API) to customize plotting options for response plots from the command line.

Note This section assumes some very basic familiarity with Handle Graphics® and object-oriented concepts, namely, classes, objects, and Handle Graphics handles. See “Classes in the MATLAB Language” and “Graphics Objects” in the MATLAB online documentation for more information.

To customize plots from the command line:

- 1 Obtain the *plot handle*, which is an identifier for the plot, using the API’s plotting syntax.

For example,

```
h=stepplot(sys)
```

returns the plot handle *h* for the step plot.

For more information on obtaining plot handles, see “Obtaining Plot Handles” on page 14-26.

- 2 Obtain the *plot options handle*, which is an identifier for all settable plot options. To get a plot options handle for a given plot, type

```
p=getoptions(h);
```

p is the plot options handle for plot handle *h*.

For more information on obtaining plot options handles, see “Obtaining Plot Options Handles” on page 14-27.

- 3 Use `setoptions`, along with the plot handle and the plot options handle, to access and modify many plot options.

Note You can also use `setoptions` to customize plots using property/value pairs instead of the plot options handle. Using property/value pairs shortens the procedure to one line of code.

Example of Changing Bode Plot Units from the Command Line

You can change of the following plot from rad/s to Hz.

```
s = tf('s');
sys= 1/(s+1);
h= bodeplot(sys);
```

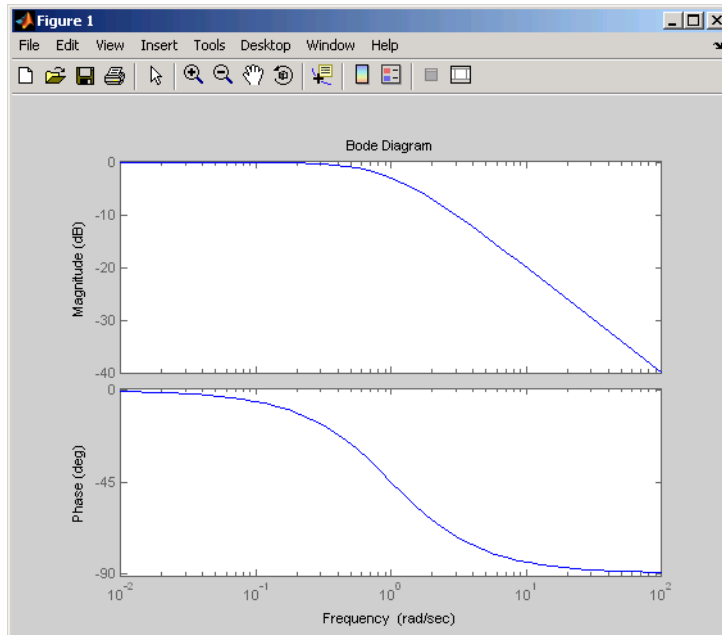

To change the units to Hz, type the following:

```
p = getoptions(h);
p.FreqUnits = 'Hz';
setoptions(h,p)
```

The units for the x -axis are now in Hz.

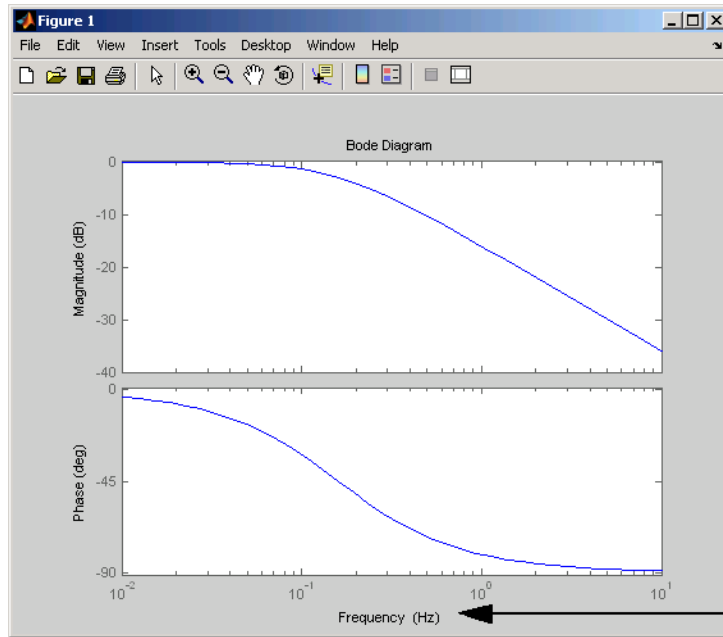

Frequency units are now in Hz.

Note You can also change the plot units to Hz using property/value pairs by typing

```
setoptions(h, 'FreqUnits', 'Hz');
```

For more examples of customizing plots from the command line, see “Examples of Customizing Plots from the Command Line” on page 14-30.

Obtaining Plot Handles

To programmatically interact with response plot, you need the *plot handle*. This handle is an identifier to the response plot object. Because the Control System Toolbox plotting commands, `bode`, `rlocus`, etc., all use the plot handle internally, this API provides a set of commands that explicitly return the handle to your response plot. These functions all end with "plot," which makes them easy to identify. This table lists the functions.

Functions That Return the Plot Handle

Function	Plot
bodeplot	Bode magnitude and phase
hsvplot	Hankel singular values
impzplot	Impulse response
initialplot	Initial condition
iozplot	Pole/zero maps for input/output pairs
lsimplot	Time response to arbitrary inputs
nicholsplot	Nichols chart
nyquistplot	Nyquist
pzplot	Pole/zero
rlocusplot	Root locus
sigmaplot	Singular values of the frequency response
stepplot	Step response

To get a plot handle for any response plot, use the functions from the table. For example,

```
h = bodeplot(sys)
```

returns plot handle `h` (it also renders the Bode plot). Once you have this handle, you can modify the plot properties using the `setoptions` and `getoptions` methods of the plot object, in this case, a Bode plot handle.

Obtaining Plot Options Handles

- “Overview of Plot Options Handles” on page 14-28
- “Retrieving a Handle” on page 14-28
- “Creating a Handle” on page 14-28
- “Which Properties Can You Modify?” on page 14-29

Overview of Plot Options Handles

Once you have the plot handle, you need the *plot options handle*, which is an identifier for all the settable plot properties for a given response plot. There are two ways to create a plot options handle:

- Retrieving a Handle — Use `getoptions` to get the handle.
- Creating a Handle — Use `<responseplot>options` to instantiate a handle. See Functions for Creating Plot Options Handles on page 14-29 for a complete list.

Retrieving a Handle

The `getoptions` function retrieves a plot options handle from a plot handle.

```
p=getoptions(h) % Returns plot options handle p for plot handle h.
```

If you specify a property name as an input argument, `getoptions` returns the property value associated with the property name.

```
property_value=getoptions(h,PropertyName) % Returns a property  
                                           % value.
```

Creating a Handle

You can create a default plot options handle by using functions in the form of

```
<responseplot>options
```

For example,

```
p=bodeoptions;
```

instantiates a handle for Bode plots. See “Properties and Values Reference” on page 14-33 for a list of default values.

If you want to set the default values to the Control System Toolbox default values, pass `cstprefs` to the function. For example,

```
p = bodeoptions('cstprefs');
```

set the Bode plot property/value pairs to the Control System Toolbox default values.

This table lists the functions that create a plot options handle.

Functions for Creating Plot Options Handles

Function	Type of Plot Options Handle Created
bodeoptions	Bode phase and magnitude
hsvoptions	Hankel singular values
nicholsoptions	Nichols plot
nyquistoptions	Nyquist plot
pzoptions	Pole/zero plot
sigmaoptions	Sigma (singular values) plot
timeoptions	Time response (impulse, step, etc.)

Which Properties Can You Modify?

Use

```
help <responseplot>options
```

to see a list of available property value pairs that you can modify. For example,

```
help bodeoptions
```

You can modify any of these parameters using `setoptions`. The next topic provides examples of modifying various response plots.

See “Properties and Values Reference” on page 14-33 for a complete list of property/value pairs for response plots.

Examples of Customizing Plots from the Command Line

- “Manipulating Plot Options Handles” on page 14-30
- “Changing Plot Units” on page 14-30
- “Create Plots Using Existing Plot Options Handle” on page 14-31
- “Creating a Default Plot Options Handle” on page 14-32
- “Using Dot Notation Like a Structure” on page 14-32
- “Setting Property Pairs in setoptions” on page 14-33

Manipulating Plot Options Handles

There are two fundamental ways to manipulate plot option handles:

- Dot notation — Treat the handle like a MATLAB structure.
- Property value pairs — Specify property/value pairs explicitly as input arguments to `setoptions`.

For some examples, both dot notation and property/value pairs approaches are shown. For all examples, use

```
sys=tf(1,[1 1])
```

for the system.

Changing Plot Units

Change the frequency units of a Bode plot from rad/s to Hz.

```
h = bodeplot(sys);  
p = getoptions(h);  
p.FreqUnits = 'Hz'  
setoptions(h,p)
```

or, for the last three lines, substitute

```
setoptions(h,'FreqUnits','Hz')
```

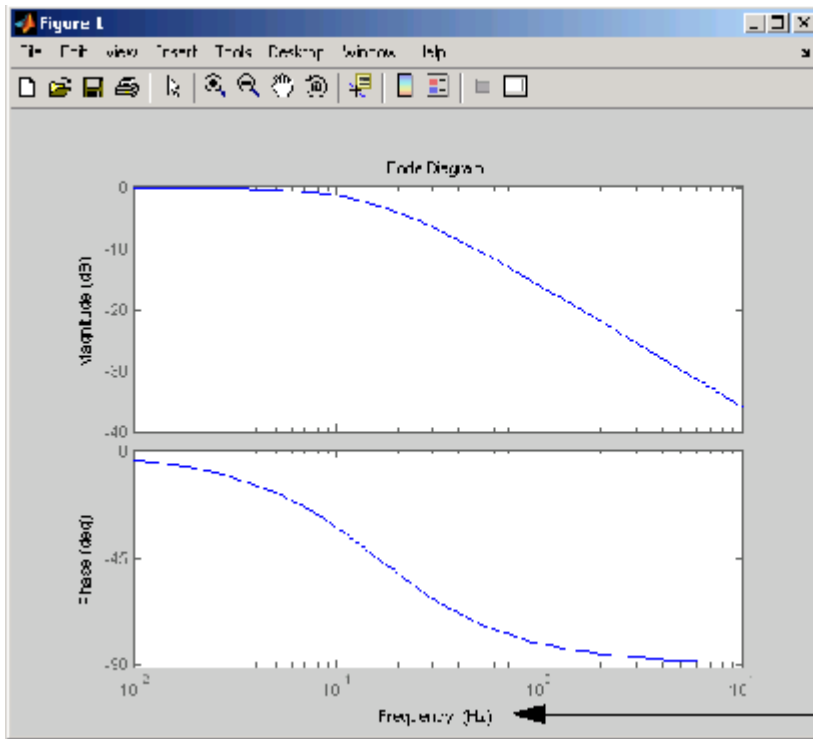
Frequency units are
now in Hz.

Create Plots Using Existing Plot Options Handle

You can use an existing plot options handle to customize a second plot:

```
h1 = bodeplot(sys);
p1 = getoptions(h1);
h2 = bodeplot(sys,p1);
```

or

```
h1 = bodeplot(sys);
h2 = bodeplot(sys2);
setoptions(h2,getoptions(h1))
```

Creating a Default Plot Options Handle

Instantiate a plot options handle with this code.

```
p = bodeoptions;
```

Change the frequency units and apply the changes to sys.

```
p.FreqUnits = 'Hz';  
h = bodeplot(sys,p);
```

Using Dot Notation Like a Structure

You can always use dot notation to assign values to properties.

```
h1 = bodeplot(sys)  
p1 = getoptions(h1)  
p1.FreqUnits = 'Hz'  
p1.Title.String = 'My Title';  
setoptions(h1,p1)
```

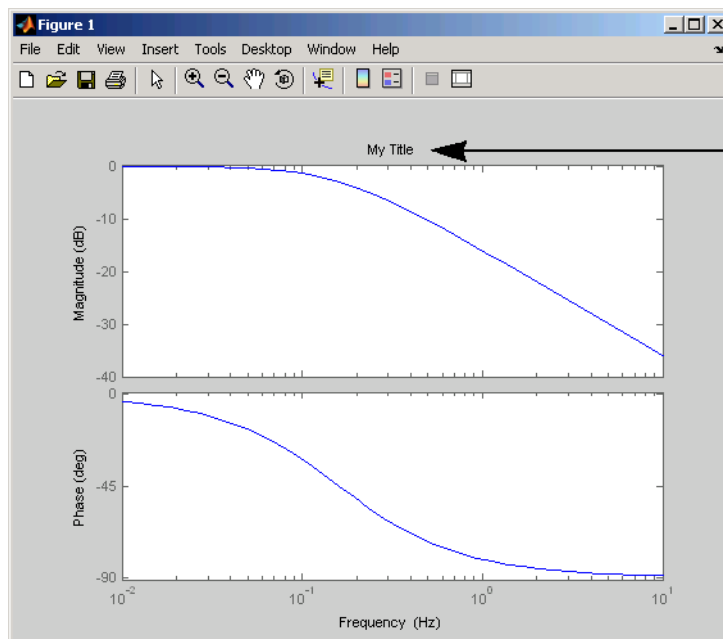

Setting Property Pairs in setoptions

Instead of using dot notation, specify frequency units as property/value pairs in setoptions.

```
h1 = bodeplot(sys)
setoptions(h1,'FreqUnits','Hz')
```

Verify that the units have changed from rad/s to Hz.

```
getoptions(h1,'FreqUnits') % Returns frequency units for h1.
```

```
ans =
```

```
Hz
```

Properties and Values Reference

- “Property/Value Pairs Common to All Response Plots” on page 14-33
- “Bode Plots” on page 14-38
- “Hankel Singular Values” on page 14-40
- “Nichols Plots” on page 14-40
- “Nyquist Charts” on page 14-42
- “Pole/Zero Maps” on page 14-43
- “Sigma Plots” on page 14-45
- “Time Response Plots” on page 14-46

Property/Value Pairs Common to All Response Plots

The following tables discuss property/value pairs common to all response plots.

Title

Property	Default Value	Description
Title.String	none	String
Title.FontSize	8	Double

Title (Continued)

Property	Default Value	Description
Title.FontWeight	normal	[light normal demi]
Title.FontAngle	normal	[normal italic oblique]
Title.Color	[0 0 0]	1-by-3 RGB vector

X Label

Property	Default Value	Description
XLabel.String	none	String
XLabel.FontSize	8	Double
XLabel.FontWeight	normal	[light normal demi]
XLabel.FontAngle	normal	[normal italic oblique]
XLabel.Color	[0 0 0]	1-by-3 RGB vector

Y Label

Property	Default Value	Description
YLabel.String	none	String
YLabel.FontSize	8	Double
YLabel.FontWeight	normal	[light normal demi]
YLabel.FontAngle	normal	[normal italic oblique]
YLabel.Color	[0 0 0]	1-by-3 RGB vector

Tick Label

Property	Default Value	Description
TickLabel.FontSize	8	Double
TickLabel.FontWeight	normal	[light normal demi]
TickLabel.FontAngle	normal	[normal italic oblique]
Ticklabel.Color	[0 0 0]	1-by-3 RGB vector

Grid and Axis Limits

Property	Default Value	Description
grid	off	[on off]
Xlim	{[]}	A cell array of 1-by-2 doubles that specifies the <i>x</i> -axis limits when XLimMode is set to manual. When XLim is scalar, scalar expansion is applied; otherwise the length of the cell array must equal the number of columns (i.e., number of system inputs) for the plot. The 1-by-2 doubles must be a strictly increasing pair [xmin, xmax].
XLimMode	{auto}	A cell array of strings [auto manual] that specifies the <i>x</i> -axis limits mode. When XLimMode is set to manual the limits are set to the values specified in XLim. When XLimMode is scalar, scalar expansion is applied; otherwise the length of the cell array must equal the number of columns (i.e., number of system inputs) for the plot.

Grid and Axis Limits (Continued)

Property	Default Value	Description
YLim	{[]}	A cell array of 1-by-2 doubles specifies the <i>y</i> -axis limits when YLimMode is set to manual. When YLim is scalar, scalar expansion is applied; otherwise the length of the cell array must equal the number of rows (i.e., number of system outputs) for the plot. The 1-by-2 doubles must be a strictly increasing pair [ymin, ymax].
YLimMode	{auto}	A cell array of strings [auto manual] that specifies the <i>y</i> -axis limits mode. When YLimMode is set to manual the limits are set to the values specified in YLim. When YLimMode is scalar, scalar expansion is applied; otherwise the length of the cell array must equal the number of rows (i.e., number of system outputs) for the plot.

I/O Grouping

Property	Default Value	Description
IOMgrouping	none	[none inputs outputs all] Specifies input/output groupings for responses.

Input Labels

Property	Default Value	Description
InputLabels.FontSize	8	Double
InputLabels.FontWeight	normal	[light normal demi]
InputLabels.FontAngle	normal	[normal italic oblique]
InputLabels.Color	[0 0 0]	1-by-3 RGB vector

Output Labels

Property	Default Value	Description
OutputLabel.FontSize	8	Double
OutputLabels.FontWeight	normal	[light normal demi]
OutputLabels.FontAngle	normal	[normal italic oblique]
OutputLabels.Color	[0 0 0]	1-by-3 RGB vector

Input/Output Visible

Property	Default Value	Description
InputVisible	{on}	[on off] A cell array that specifies the visibility of each input channel. If the value is a scalar, scalar expansion is applied.
OutputVisible	{on}	[on off] A cell array that specifies the visibility of each output channel. If the value is a scalar, scalar expansion is applied.

Bode Plots

Property	Default Value	Description
FreqUnits	rad/s	<p>Available Options</p> <ul style="list-style-type: none"> • 'Hz' • 'rad/s' • 'rpm' • 'kHz' • 'MHz' • 'GHz' • 'rad/nanosecond' • 'rad/microsecond' • 'rad/millisecond' • 'rad/minute' • 'rad/hour'

Property	Default Value	Description
		<ul style="list-style-type: none"> • 'rad/day' • 'rad/week' • 'rad/month' • 'rad/year' • 'cycles/nanosecond' • 'cycles/microsecond' • 'cycles/millisecond' • 'cycles/hour' • 'cycles/day' • 'cycles/week' • 'cycles/month' • 'cycles/year'
FreqScale	log	[linear log]
MagUnits	dB	[db abs]
MagScale	linear	[linear log]
PhaseUnits	deg	[rad deg]
PhaseWrapping	off	[on off]
MagVisible	on	[on off]
PhaseVisible	on	[on off]
MagLowerLimMode	auto	[auto manual] Enables a manual lower magnitude limit specification by MagLowerLim.
MagLowerLim	0	Double Specifies the lower magnitude limit when MagLowerLimMode is set to manual.

Property	Default Value	Description
PhaseMatching	off	[on off] Enables adjusting phase effects for phase response.
PhaseMatchingFreq	0	Double
PhaseMatchingValue	0	Double

Hankel Singular Values

Property	Default Value	Description
Yscale	linear	[linear log]
AbsTol	0	Double See hsvd and stabsep for details.
RelTol	1*e-08	Double See hsvd and stabsep for details.
Offset	1*e-08	Double See hsvd and stabsep for details.

Nichols Plots

Property	Default Value	Description
FreqUnits	rad/s	<p>Available Options</p> <ul style="list-style-type: none"> 'Hz' 'rad/s' 'rpm' 'kHz' 'MHz' 'GHz' 'rad/nanosecond'

Property	Default Value	Description
		<ul style="list-style-type: none"> • 'rad/microsecond' • 'rad/millisecond' • 'rad/minute' • 'rad/hour' • 'rad/day' • 'rad/week' • 'rad/month' • 'rad/year' • 'cycles/nanosecond' • 'cycles/microsecond' • 'cycles/millisecond' • 'cycles/hour' • 'cycles/day' • 'cycles/week' • 'cycles/month' • 'cycles/year'
MagUnits	dB	[dB abs]
PhaseUnits	deg	[rad deg]
MagLowerLimMode	auto	[auto manual]
MagLowerLim	0	double
PhaseMatching	off	[on off]
PhaseMatchingFreq	0	Double
PhaseMatchingValue	0	Double

Nyquist Charts

Property	Default Value	Description
FreqUnits	rad/s	<p>Available Options</p> <ul style="list-style-type: none"> • 'Hz' • 'rad/s' • 'rpm' • 'kHz' • 'MHz' • 'GHz' • 'rad/nanosecond' • 'rad/microsecond' • 'rad/millisecond' • 'rad/minute' • 'rad/hour' • 'rad/day' • 'rad/week' • 'rad/month' • 'rad/year' • 'cycles/nanosecond' • 'cycles/microsecond' • 'cycles/millisecond' • 'cycles/hour' • 'cycles/day' • 'cycles/week' • 'cycles/month'

Property	Default Value	Description
		<ul style="list-style-type: none"> 'cycles/year'
MagUnits	dB	[dB abs]
PhaseUnits	deg	[rad deg]
ShowFullContour	on	[on off]

Pole/Zero Maps

Property	Default Value	Description
FreqUnits	rad/s	<p>Available Options</p> <ul style="list-style-type: none"> 'Hz' 'rad/s' 'rpm' 'kHz' 'MHz' 'GHz' 'rad/nanosecond' 'rad/microsecond' 'rad/millisecond' 'rad/minute' 'rad/hour' 'rad/day' 'rad/week' 'rad/month' 'rad/year'

Property	Default Value	Description
		<ul style="list-style-type: none"> • 'cycles/nanosecond' • 'cycles/microsecond' • 'cycles/millisecond' • 'cycles/hour' • 'cycles/day' • 'cycles/week' • 'cycles/month' • 'cycles/year'
TimeUnits	seconds	<p>Available Options</p> <ul style="list-style-type: none"> • 'nanoseconds' • 'microseconds' • 'milliseconds' • 'seconds' • 'minutes' • 'hours' • 'days' • 'weeks' • 'months' • 'years'

Sigma Plots

Property	Default Value	Description
FreqUnits	rad/s	<p>Available Options</p> <ul style="list-style-type: none"> • 'Hz' • 'rad/s' • 'rpm' • 'kHz' • 'MHz' • 'GHz' • 'rad/nanosecond' • 'rad/microsecond' • 'rad/millisecond' • 'rad/minute' • 'rad/hour' • 'rad/day' • 'rad/week' • 'rad/month' • 'rad/year' • 'cycles/nanosecond' • 'cycles/microsecond' • 'cycles/millisecond' • 'cycles/hour' • 'cycles/day' • 'cycles/week' • 'cycles/month'

Property	Default Value	Description
		<ul style="list-style-type: none"> 'cycles/year'
FreqScale	log	[linear log]
MagUnits	dB	[dB abs]
MagScale	linear	[linear log]

Time Response Plots

Property	Default Value	Description
Normalize	off	[on off] Normalize the y-scale of all responses in the plot.
SettleTimeThreshold	0.02	Double Specifies the settling time threshold. 0.02 = 2%.
RiseTimeLimits	[0.1, 0.9]	1-by-2 double Specifies the limits used to define the rise time. [0.1, 0.9] is 10% to 90%.
TimeUnits	seconds	<p>Available Options</p> <ul style="list-style-type: none"> 'nanoseconds' 'microseconds' 'milliseconds' 'seconds' 'minutes' 'hours' 'days' 'weeks'

Property	Default Value	Description
		<ul style="list-style-type: none"> 'months' 'years'

Property Organization Reference

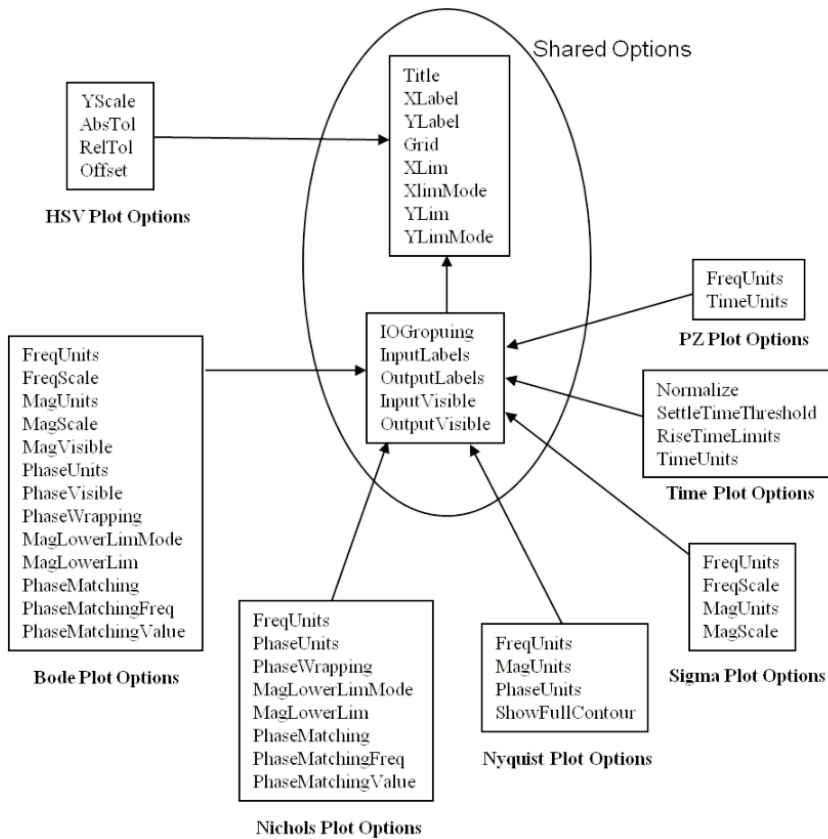

Customizing Plots Inside the SISO Design Tool

In this section...
“Overview of Customizing SISO Design Tool Plots” on page 14-48
“Root Locus Property Editor” on page 14-48
“Open-Loop Bode Property Editor” on page 14-52
“Open-Loop Nichols Property Editor” on page 14-55
“Prefilter Bode Property Editor” on page 14-57

Overview of Customizing SISO Design Tool Plots

Customizing plots inside the SISO Design Tool is similar to how you customize any response plot. The following property editors are specific to the SISO Design Tool:

- Root Locus Property Editor
- Open-Loop Bode Property Editor
- Open-Loop Nichols Property Editor
- Prefilter Bode Property Editor

You can use each of these property editors to create the customized plots within the SISO Design tool.

Root Locus Property Editor

There are three ways to open the Property Editor for root locus plots:

- Double-click in the root locus away from the curve
- Select **Properties** from the right-click menu
- Select **Root Locus** and then **Properties** from Edit in the menu bar

This figure shows the **Property Editor: Root Locus** window.

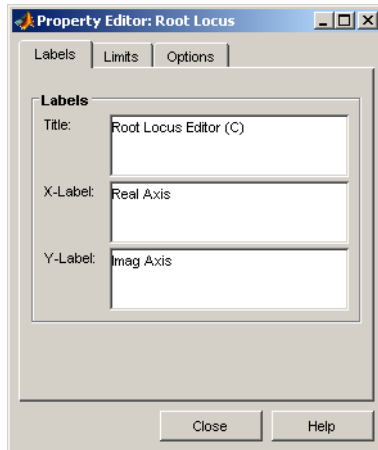

- “Labels Pane” on page 14-49
- “Limits Pane” on page 14-50
- “Options Pane” on page 14-51

Labels Pane

You can use the **Label** pane to specify plot titles and axis labels. To specify a new label, type the string in the appropriate field. The root locus plot automatically updates.

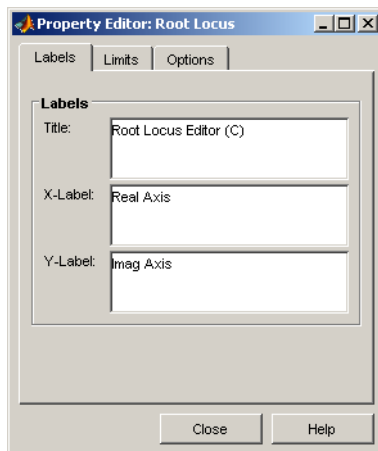

Limits Pane

The SISO Design Tool specifies default values for the real and imaginary axes ranges to make sure that all the poles and zeros in your model appear in the root locus plot. Use the Limits pane, shown below, to override the default settings.

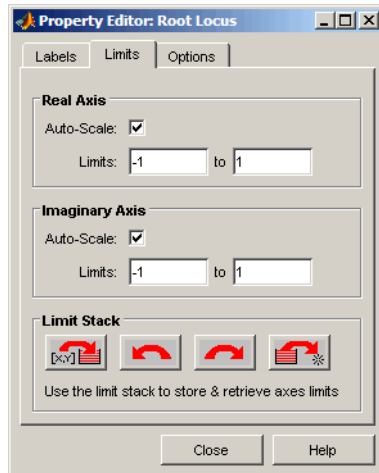

To change the limits, specify the new limits in the real and imaginary axes **Limits** fields. The **Auto-Scale** check box automatically clears once you click in a different field. Your root locus diagram updates immediately. If you want to reapply the default limits, select the **Auto-Scale** check boxes again.

The Limit Stack pane provides support for storing and retrieving custom limit specifications. There are four buttons available:



— Add the current limits to the stack



— Retrieve the previous stack entry



— Retrieve the next stack entry



— Remove the current limits from the stack

Using these buttons, you can store and retrieve any number of saved custom axes limits.

Options Pane

The Options pane contains settings for adding a grid and changing the plot's aspect ratio.

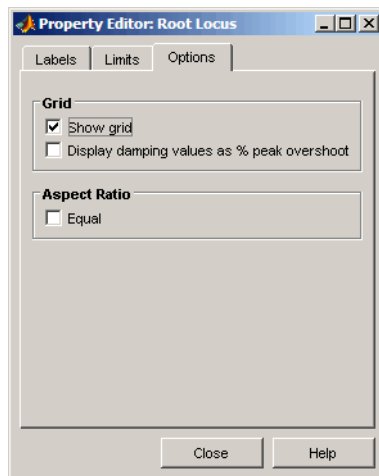

Select **Show grid** to display a grid on the root locus. If you have damping ratio constraints on your root locus, selecting **Display damping ratios as % peak overshoot** displays the damping ratio values along the grid lines. This figure shows both options activated for an imported model, Gservo. If you want to verify these settings, type

```
load ltiexamples
```

at the MATLAB prompt and import Gservo from the workspace into your SISO Design Tool.

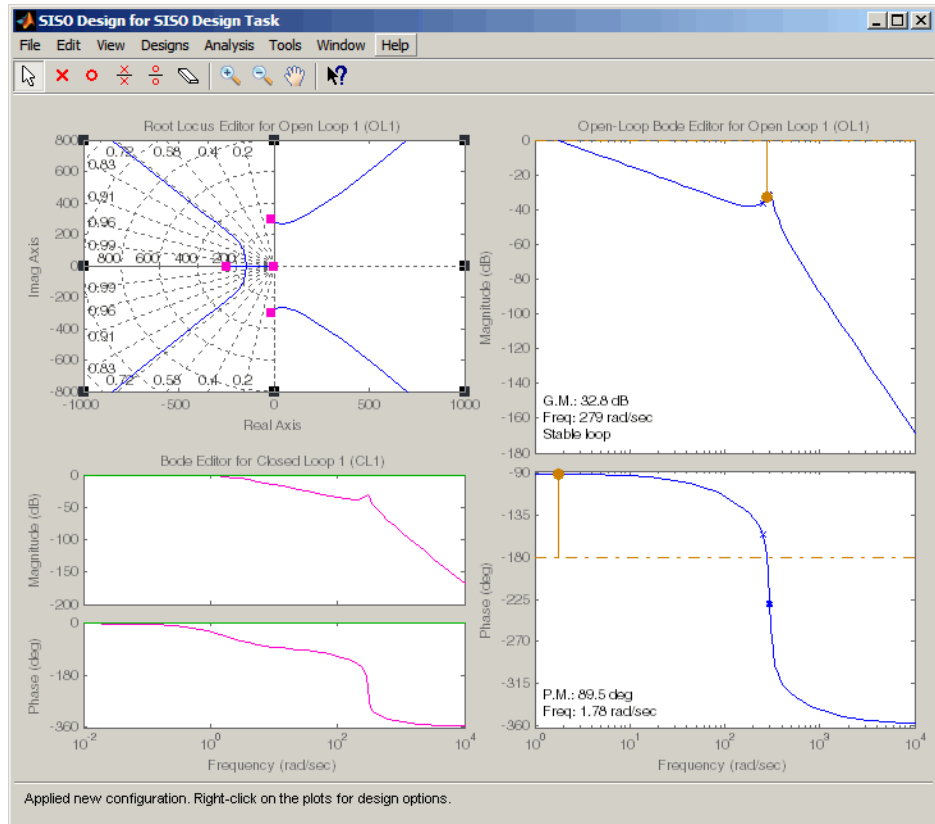

The numbers displayed on the root locus gridlines are the damping ratios as a percentage of the overshoot values.

If you select the **Equal** check box in the **Aspect Ratio** pane, the x and y -axes are set to equal limit values.

Open-Loop Bode Property Editor

As is the case with the root locus Property Editor, there are three ways to open the Bode diagram property editor:

- Double-click in the Bode magnitude or phase plot away from the curve.

- Select **Properties** from the right-click menu.
- Select **Open-Loop Bode** and then **Properties** from **Edit** in the menu bar.

This figure shows the **Property Editor: Open-Loop Bode** editor.

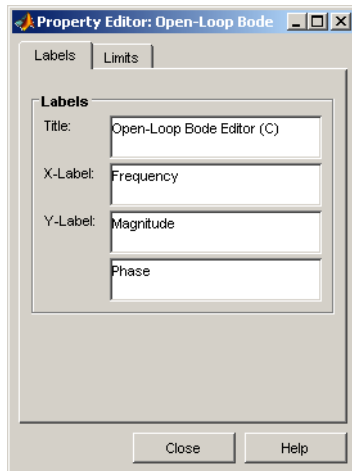

- “Labels Pane” on page 14-53
- “Limits Pane” on page 14-54

Labels Pane

You can use the **Label** pane to specify plot titles and axis labels. To specify a new label, type the string in the appropriate field. The Bode diagram automatically updates.

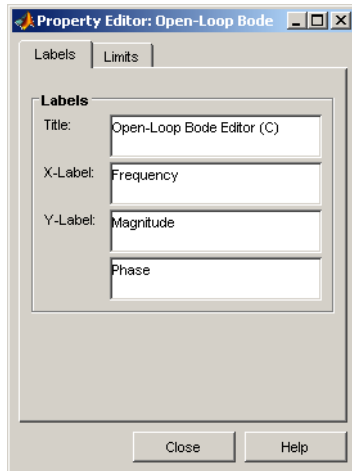

Limits Pane

You can use the Limits pane to override the default limits for the frequency, magnitude, and phase scales for your plots.

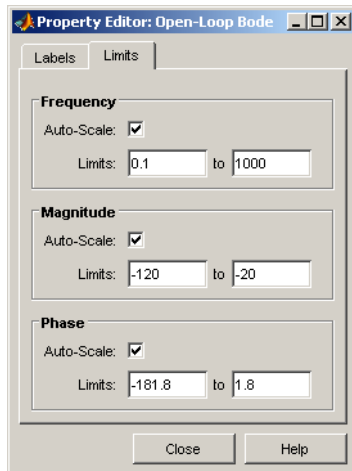

To change the limits, specify the new values in the **Limits** fields for frequency, magnitude, and phase. The **Auto-Scale** check box automatically deactivates once you click in a different field. The Bode diagram updates immediately.

To restore the default settings, select the **Auto-Scale** boxes again.

Open-Loop Nichols Property Editor

As is the case with the root locus Property Editor, there are three ways to open the Nichols plot property editor:

- Double-click in the Nichols plot away from the curve.
- Select **Properties** from the right-click menu.
- Select **Open-Loop Nichols** and then **Properties** from **Edit** in the menu bar.

This figure shows the **Property Editor: Open-Loop Nichols** editor.

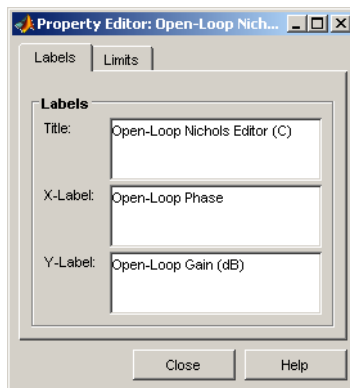

- “Labels Pane” on page 14-55
- “Limits Pane” on page 14-56

Labels Pane

You can use the Label pane to specify plot titles and axis labels. To specify a new label, type the string in the appropriate field. The Nichols plot automatically updates.

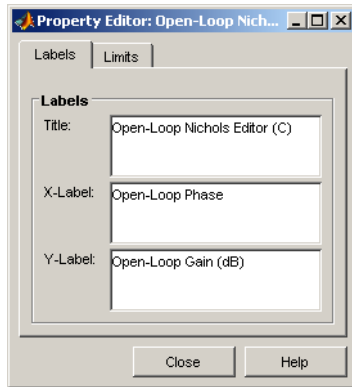

Limits Pane

You can use the Limits pane to override the default limits for the frequency, magnitude, and phase scales for your plots.

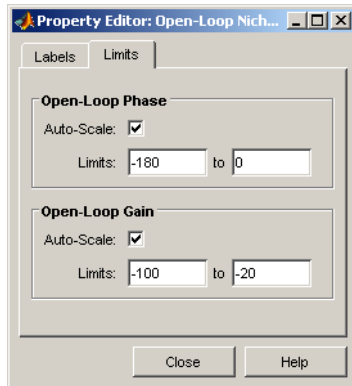

To change the limits, specify the new values in the **Limits** fields for open-loop phase and/or gain. The **Auto-Scale** check box automatically deactivates once you click in a different field. The Nichols plot updates immediately.

To restore the default settings, select the **Auto-Scale** boxes again.

Prefilter Bode Property Editor

The **Prefilter Bode Property** editor is identical to the Open-Loop Bode diagram property editor. There are three ways to open the prefilter editor:

- Double-click in the prefilter Bode magnitude or phase plot away from the curve.
- Select **Properties** from the right-click menu.
- Select **Prefilter Bode** and then **Properties** from **Edit** in the menu bar.

See “Open-Loop Bode Property Editor” on page 14-52 for a description of the features of this editor.

Design Case Studies

- “Design Yaw Damper for Jet Transport” on page 15-2
- “Hard-Disk Read/Write Head Controller” on page 15-19
- “LQG Regulation: Rolling Mill Case Study” on page 15-30
- “Kalman Filtering” on page 15-49

Design Yaw Damper for Jet Transport

In this section...

“Overview of this Case Study” on page 15-2
 “Creating the Jet Model” on page 15-2
 “Computing Open-Loop Eigenvalues” on page 15-4
 “Open-Loop Analysis” on page 15-5
 “Root Locus Design” on page 15-8
 “Washout Filter Design” on page 15-13

Overview of this Case Study

This case study demonstrates the tools for classical control design by stepping through the design of a yaw damper for a 747[®] jet transport aircraft.

Creating the Jet Model

The jet model during cruise flight at MACH = 0.8 and H = 40,000 ft. is

```
A=[ -.0558  -.9968  .0802  .0415;
     .598   -.115   -.0318  0;
    -3.05   .388   -.4650  0;
     0   0.0805  1  0];
```

```
B=[ .00729  0;
    -0.475  0.00775;
     0.153  0.143;
     0      0];
```

```
C=[0 1 0 0;
    0 0 0 1];
```

```
D=[0 0;
    0 0];
```

```
sys = ss(A,B,C,D);
```

The following commands specify this state-space model as an LTI object and attach names to the states, inputs, and outputs.

```
states = {'beta' 'yaw' 'roll' 'phi'};
inputs = {'rudder' 'aileron'};
outputs = {'yaw' 'bank angle'};

sys = ss(A,B,C,D,'statename',states,...
         'inputname',inputs,...
         'outputname',outputs);
```

You can display the LTI model `sys` by typing `sys`. This command produces the following result.

```
a =
      beta    yaw    roll    phi
beta -0.0558 -0.9968  0.0802  0.0415
yaw   0.598  -0.115 -0.0318    0
roll -3.05   0.388 -0.465    0
phi   0      0.0805    1      0
```

```
b =
      rudder  aileron
beta  0.00729    0
yaw   -0.475   0.00775
roll  0.153    0.143
phi   0        0
```

```
c =
      beta  yaw  roll  phi
yaw        0   1   0   0
bank angle  0   0   0   1
```

```
d =
      rudder  aileron
yaw          0      0
bank angle   0      0
```

Continuous-time model.

The model has two inputs and two outputs. The units are radians for β (sideslip angle) and ϕ (bank angle) and radians/sec for yaw (yaw rate) and roll (roll rate). The rudder and aileron deflections are in radians as well.

Computing Open-Loop Eigenvalues

Compute the open-loop eigenvalues and plot them in the s -plane.

```
damp(sys)
```

Eigenvalue	Damping	Freq. (rad/s)
-7.28e-003	1.00e+000	7.28e-003
-5.63e-001	1.00e+000	5.63e-001
-3.29e-002 + 9.47e-001i	3.48e-002	9.47e-001
-3.29e-002 - 9.47e-001i	3.48e-002	9.47e-001

```
pzmap(sys)
```

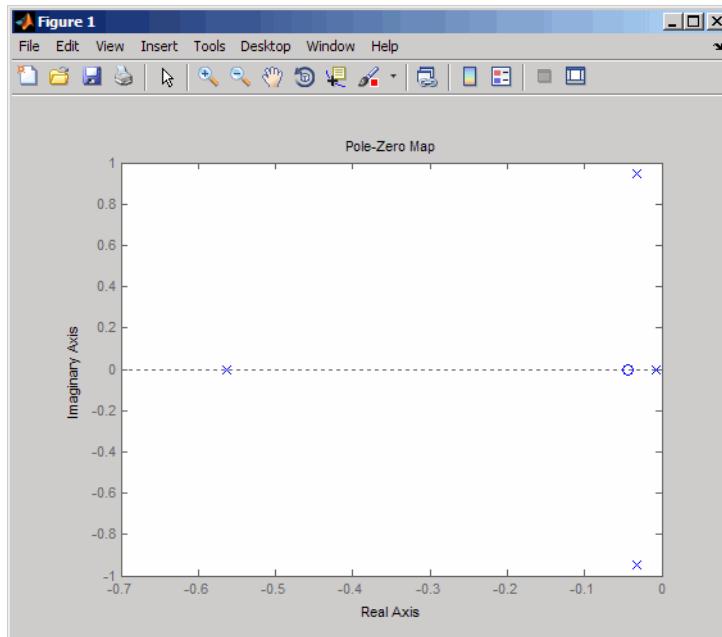

This model has one pair of lightly damped poles. They correspond to what is called the "Dutch roll mode."

Suppose you want to design a compensator that increases the damping of these poles, so that the resulting complex poles have a damping ratio $\zeta > 0.35$ with natural frequency $\omega_n < 1$ rad/sec. You can do this using the Control System Toolbox analysis tools.

Open-Loop Analysis

First, perform some open-loop analysis to determine possible control strategies. Start with the time response (you could use `step` or `impulse` here).

```
impulse(sys)
```

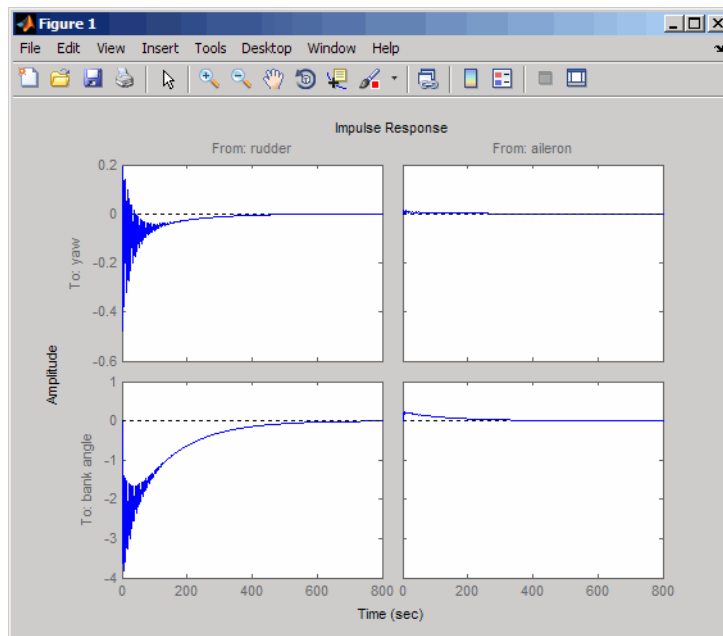

The impulse response confirms that the system is lightly damped. But the time frame is much too long because the passengers and the pilot are more concerned about the behavior during the first few seconds rather than the

first few minutes. Next look at the response over a smaller time frame of 20 seconds.

```
impulse(sys,20)
```

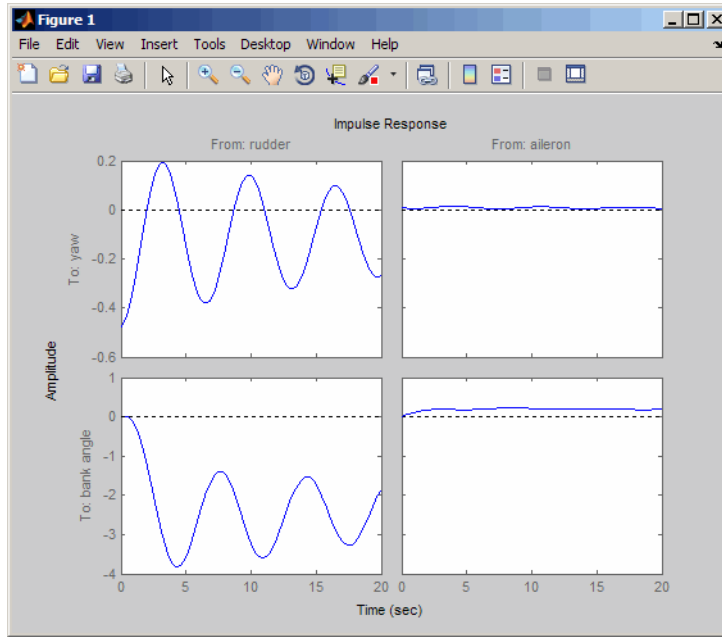

Look at the plot from aileron (input 2) to bank angle (output 2). To show only this plot, right-click and choose **I/O Selector**, then click on the (2,2) entry. The I/O Selector should look like this.

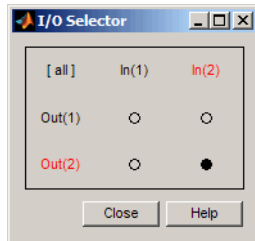

The new figure is shown below.

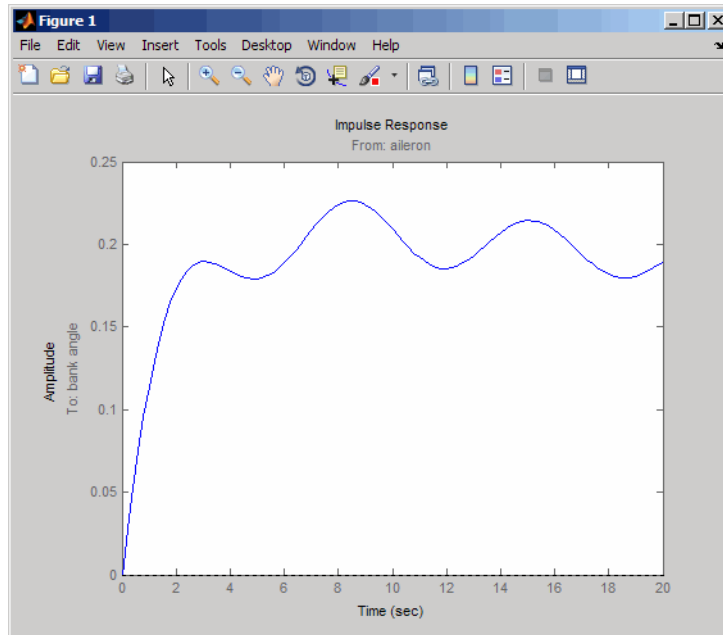

The aircraft is oscillating around a nonzero bank angle. Thus, the aircraft is turning in response to an aileron impulse. This behavior will prove important later in this case study.

Typically, yaw dampers are designed using the yaw rate as sensed output and the rudder as control input. Look at the corresponding frequency response.

```
sys11=sys('yaw','rudder') % Select I/O pair.  
bode(sys11)
```

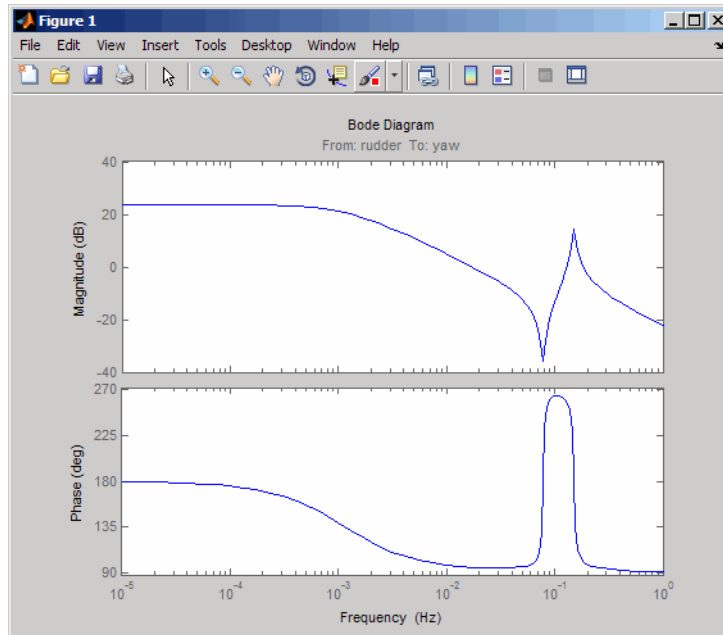

From this Bode diagram, you can see that the rudder has significant effect around the lightly damped Dutch roll mode (that is, near $\omega = 1$ rad/sec).

Root Locus Design

A reasonable design objective is to provide a damping ratio $\zeta > 0.35$ with a natural frequency $\omega_n < 1.0$ rad/sec. Since the simplest compensator is a static gain, first try to determine appropriate gain values using the root locus technique.

```
% Plot the root locus for the rudder to yaw channel  
rlocus(sys11)
```

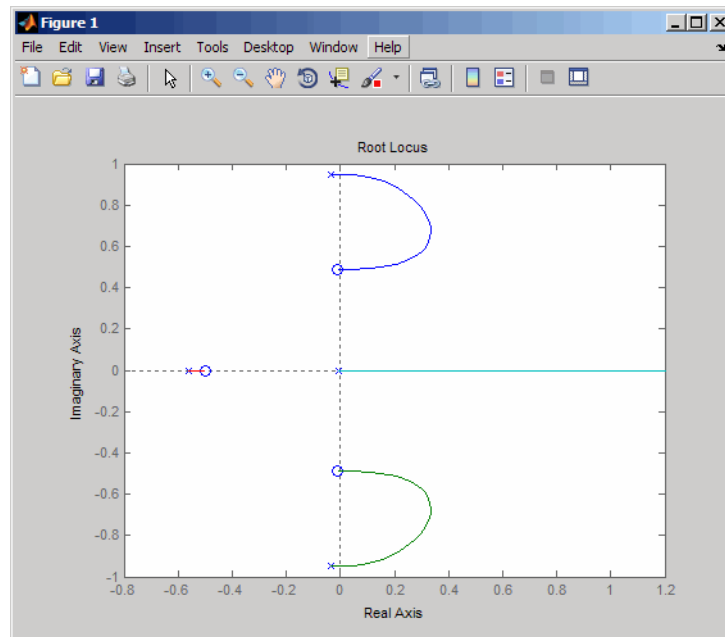

This is the root locus for negative feedback and shows that the system goes unstable almost immediately. If, instead, you use positive feedback, you may be able to keep the system stable.

```
rlocus(-sys11)  
sgrid
```

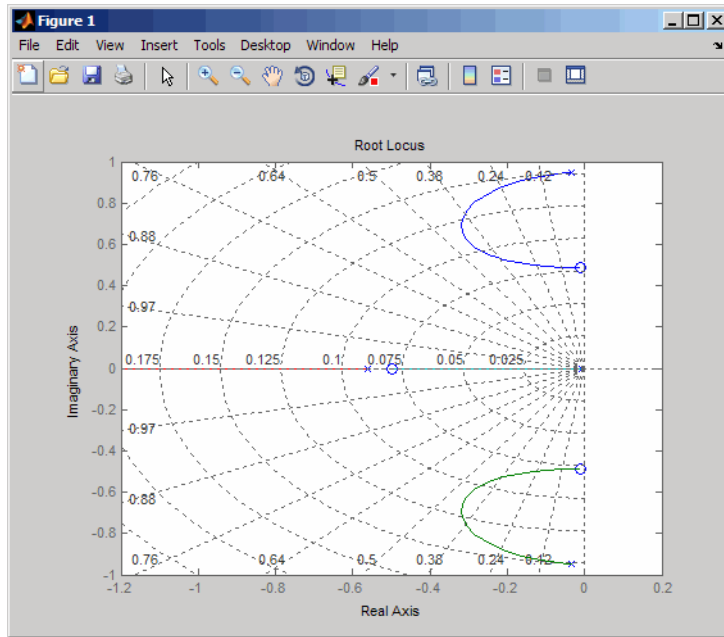

This looks better. By using simple feedback, you can achieve a damping ratio of $\zeta > 0.45$. Click on the blue curve and move the data marker to track the gain and damping values. To achieve a 0.45 damping ratio, the gain should be about 2.85. This figure shows the data marker with similar values.

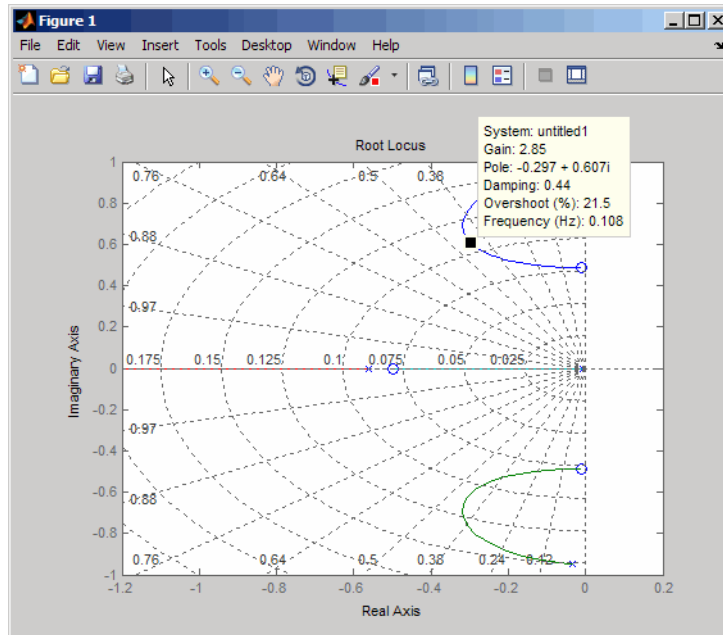

Next, close the SISO feedback loop.

```
K = 2.85;
c111 = feedback(sys11, -K); % Note: feedback assumes negative
                             % feedback by default
```

Plot the closed-loop impulse response for a duration of 20 seconds, and compare it to the open-loop impulse response.

```
impulse(sys11, 'b--', c111, 'r', 20)
```

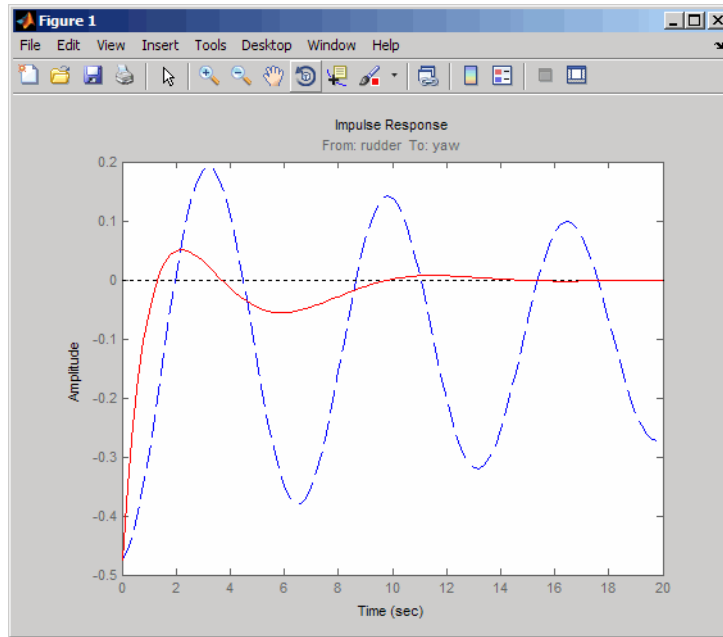

The closed-loop response settles quickly and does not oscillate much, particularly when compared to the open-loop response.

Now close the loop on the full MIMO model and see how the response from the aileron looks. The feedback loop involves input 1 and output 1 of the plant (use feedback with index vectors selecting this input/output pair). At the MATLAB prompt, type

```
cloop = feedback(sys, -K, 1, 1);
damp(cloop) % closed-loop poles
```

Eigenvalue	Damping	Freq. (rad/s)
-3.42e-001	1.00e+000	3.42e-001
-2.97e-001 + 6.06e-001i	4.40e-001	6.75e-001
-2.97e-001 - 6.06e-001i	4.40e-001	6.75e-001
-1.05e+000	1.00e+000	1.05e+000

Plot the MIMO impulse response.

```
impz(sys, 'b- -', cloop, 'r', 20)
```

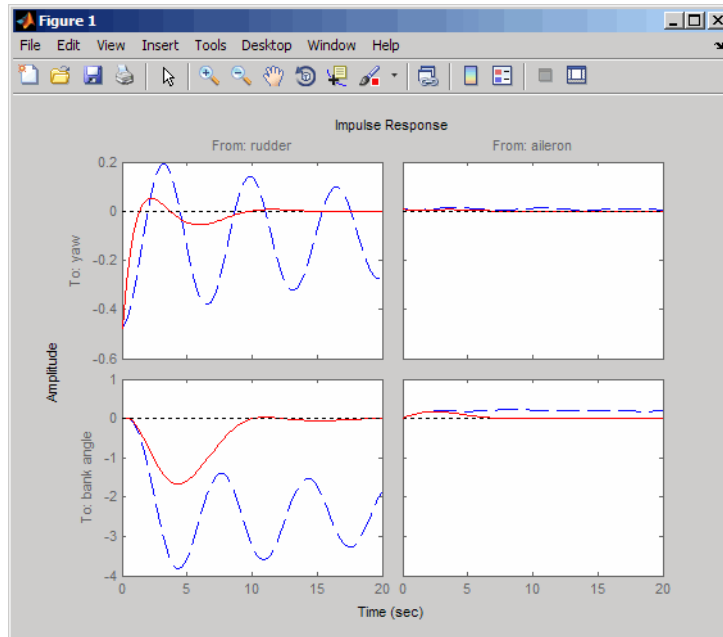

The yaw rate response is now well damped, but look at the plot from aileron (input 2) to bank angle (output 2). When you move the aileron, the system no longer continues to bank like a normal aircraft. You have over-stabilized the spiral mode. The spiral mode is typically a very slow mode and allows the aircraft to bank and turn without constant aileron input. Pilots are used to this behavior and will not like your design if it does not allow them to fly normally. This design has moved the spiral mode so that it has a faster frequency.

Washout Filter Design

What you need to do is make sure the spiral mode does not move further into the left-half plane when you close the loop. One way flight control designers have addressed this problem is to use a washout filter $kH(s)$ where

$$H(s) = \frac{s}{s + \alpha}$$

The washout filter places a zero at the origin, which constrains the spiral mode pole to remain near the origin. We choose $\alpha = 0.2$ for a time constant of five seconds and use the root locus technique to select the filter gain H . First specify the fixed part $s/(s + \alpha)$ of the washout by

```
H = zpk(0, -0.2, 1);
```

Connect the washout in series with the design model `sys11` (relation between input 1 and output 1) to obtain the open-loop model

```
olloop = H * sys11;
```

and draw another root locus for this open-loop model.

```
rlocus(-olloop)
sgrid
```

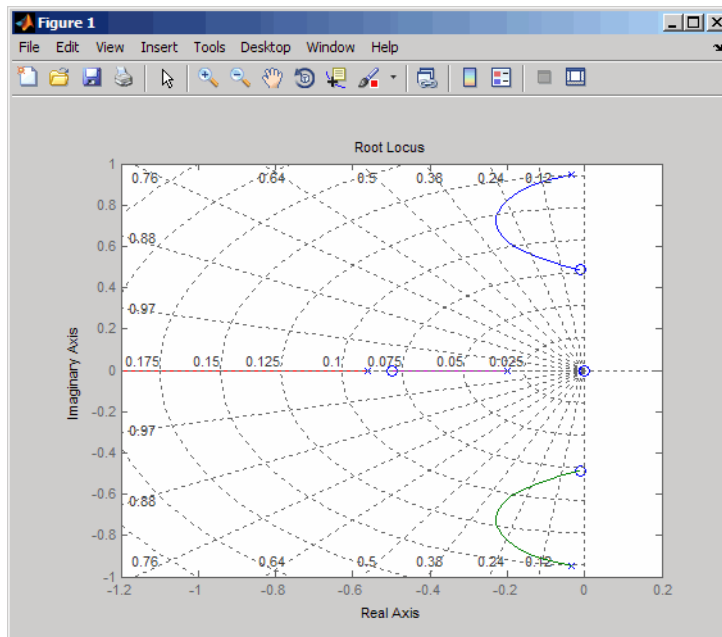

Create and drag a data marker around the upper curve to locate the maximum damping, which is about $\zeta = 0.3$.

This figure shows a data marker at the maximum damping ratio; the gain is approximately 2.07.

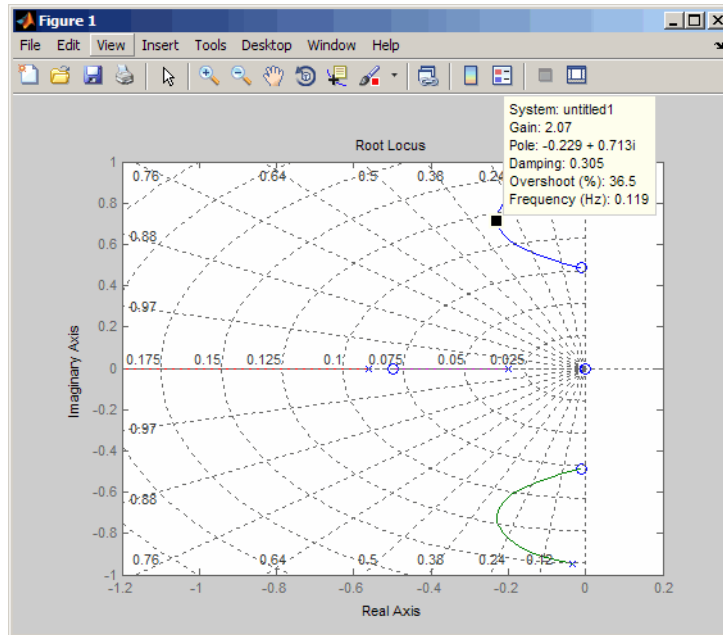

Look at the closed-loop response from rudder to yaw rate.

```
K = 2.07;  
c111 = feedback(olloop, -K);  
impulse(c111, 20)
```

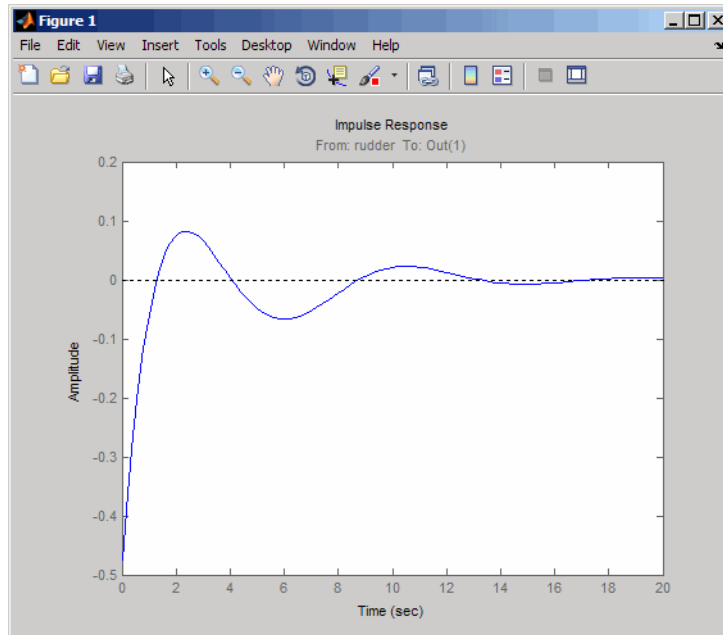

The response settles nicely but has less damping than your previous design. Finally, you can verify that the washout filter has fixed the spiral mode problem. First form the complete washout filter $kH(s)$ (washout + gain).

$$\text{WOF} = -K * H;$$

Then close the loop around the first I/O pair of the MIMO model `sys` and simulate the impulse response.

```
cloop = feedback(sys,WOF,1,1);
```

```
% Final closed-loop impulse response
impulse(sys,'b--',cloop,'r',20)
```

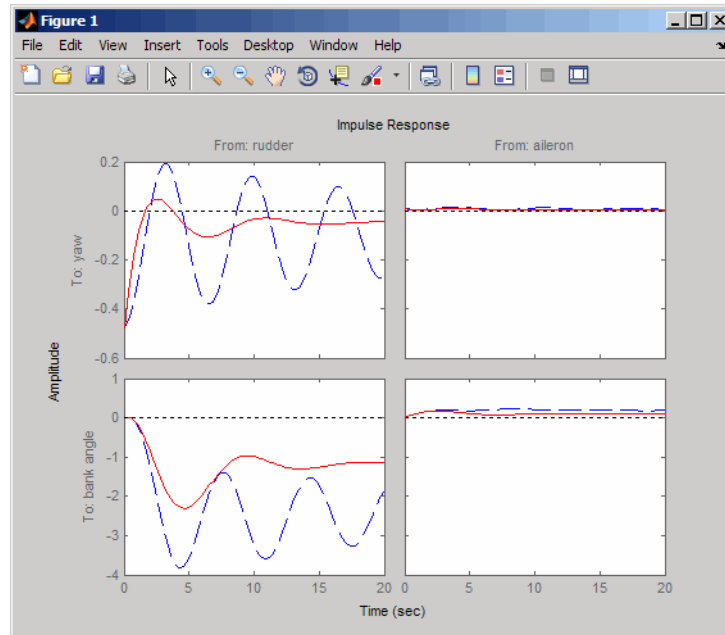

The bank angle response (output 2) due to an aileron impulse (input 2) now has the desired nearly constant behavior over this short time frame. To inspect the response more closely, use the I/O Selector in the right-click menu to select the (2,2) I/O pair.

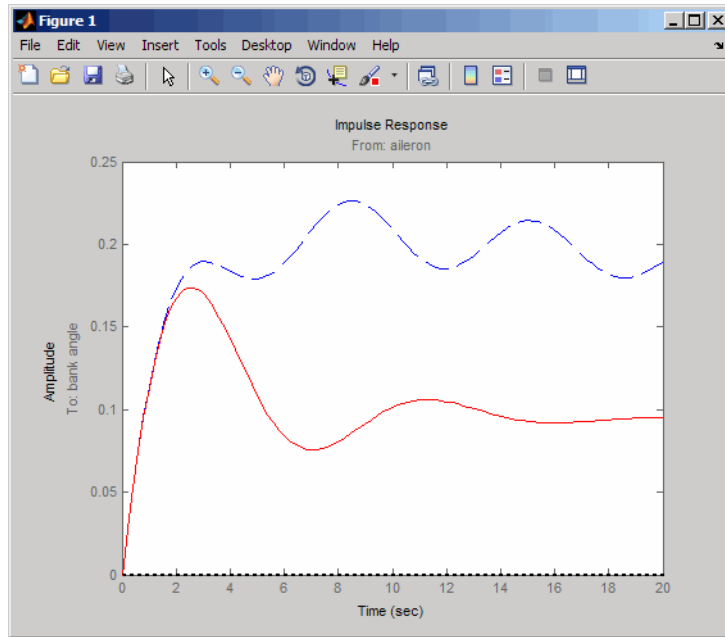

Although you did not quite meet the damping specification, your design has increased the damping of the system substantially and now allows the pilot to fly the aircraft normally.

Hard-Disk Read/Write Head Controller

In this section...

“Overview of this Case Study” on page 15-19

“Creating the Read/Write Head Model” on page 15-19

“Model Discretization” on page 15-20

“Adding a Compensator Gain” on page 15-22

“Adding a Lead Network” on page 15-23

“Design Analysis” on page 15-26

Overview of this Case Study

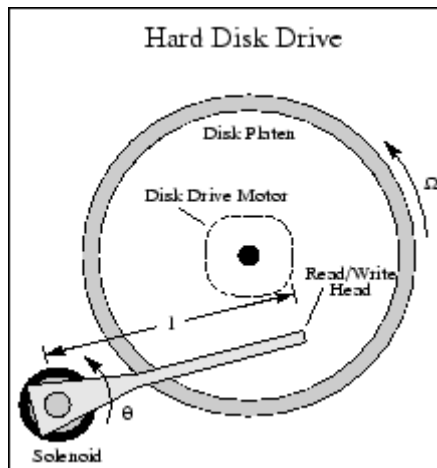

This case study demonstrates the ability to perform classical digital control design by going through the design of a computer hard-disk read/write head position controller.

Creating the Read/Write Head Model

Using Newton's law, a simple model for the read/write head is the differential equation

$$J \frac{d^2\theta}{dt^2} + C \frac{d\theta}{dt} + K\theta = K_i i$$

where J is the inertia of the head assembly, C is the viscous damping coefficient of the bearings, K is the return spring constant, K_i is the motor torque constant, θ is the angular position of the head, and i is the input current.

Taking the Laplace transform, the transfer function from i to θ is

$$H(s) = \frac{K_i}{Js^2 + Cs + K}$$

Using the values $J = 0.01 \text{ kg } m^2$, $C = 0.004 \text{ Nm/(rad/sec)}$, $K = 10 \text{ Nm/rad}$, and $K_i = 0.05 \text{ Nm/rad}$, form the transfer function description of this system. At the MATLAB prompt, type

```
J = .01; C = 0.004; K = 10; Ki = .05;
num = Ki;
den = [J C K];
H = tf(num,den)
```

These commands produce the following result.

```
Transfer function:
          0.05
-----
0.01 s^2 + 0.004 s + 10
```

Model Discretization

The task here is to design a digital controller that provides accurate positioning of the read/write head. The design is performed in the digital domain. First, discretize the continuous plant. Because our plant will be equipped with a digital-to-analog converter (with a zero-order hold) connected to its input, use `c2d` with the 'zoh' discretization method. Type

```
Ts = 0.005;      % sampling period = 0.005 second
Hd = c2d(H,Ts,'zoh')
Transfer function:
```

$$\frac{6.233e-05 z + 6.229e-05}{z^2 - 1.973 z + 0.998}$$

Sampling time: 0.005

You can compare the Bode plots of the continuous and discretized models with

`bodeplot(H, '-', Hd, '--')`

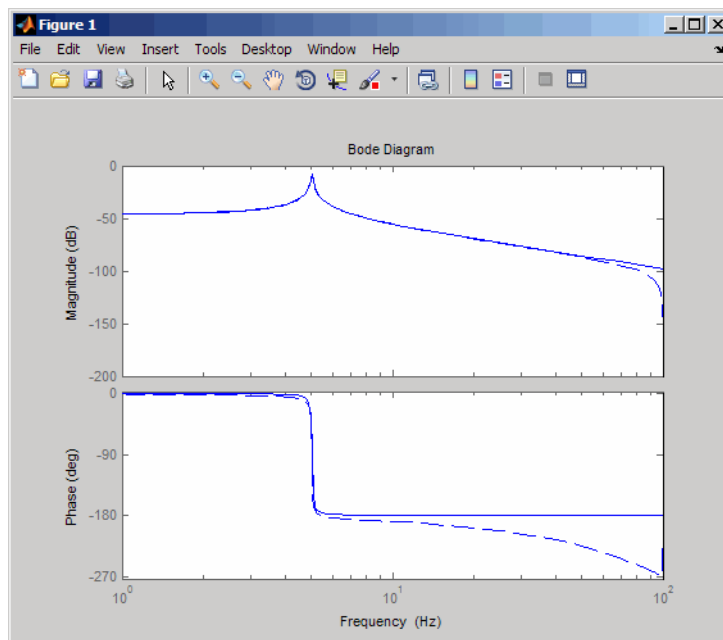

To analyze the discrete system, plot its step response, type

`step(Hd)`

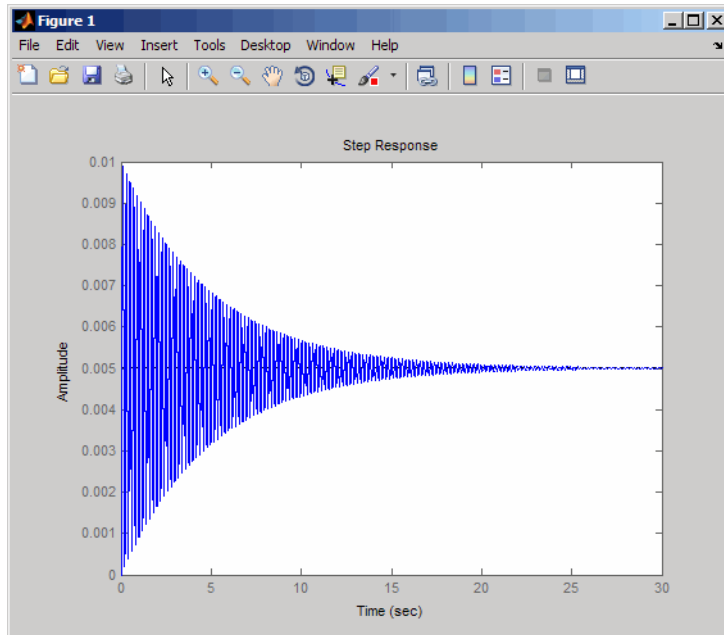

The system oscillates quite a bit. This is probably due to very light damping. You can check this by computing the open-loop poles. Type

```
% Open-loop poles of discrete model
damp(Hd)
```

Eigenvalue	Magnitude	Equiv. Damping	Equiv. Freq.
9.87e-01 + 1.57e-01i	9.99e-01	6.32e-03	3.16e+01
9.87e-01 - 1.57e-01i	9.99e-01	6.32e-03	3.16e+01

The poles have very light equivalent damping and are near the unit circle. You need to design a compensator that increases the damping of these poles.

Adding a Compensator Gain

The simplest compensator is just a gain, so try the root locus technique to select an appropriate feedback gain.

```
rlocus(Hd)
```

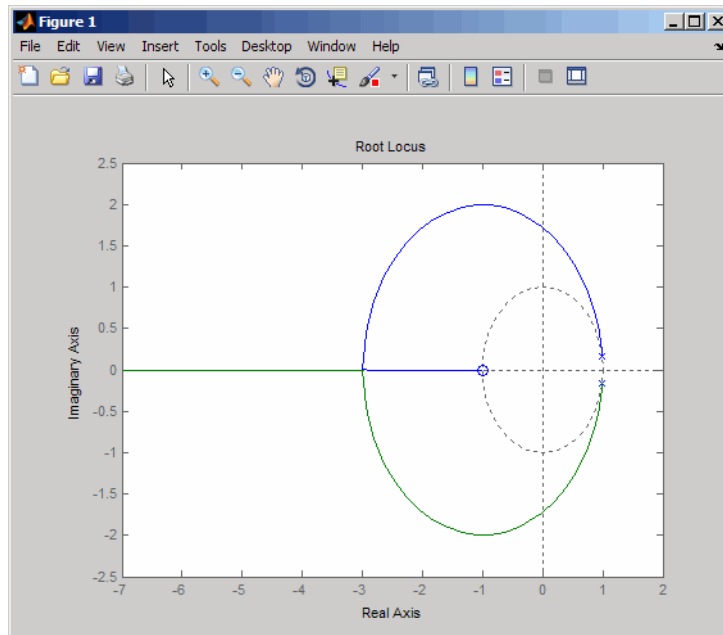

As shown in the root locus, the poles quickly leave the unit circle and go unstable. You need to introduce some lead or a compensator with some zeros.

Adding a Lead Network

Try the compensator

$$D(z) = \frac{z + \alpha}{z + b}$$

with $\alpha = -0.85$ and $b = 0$.

The corresponding open-loop model

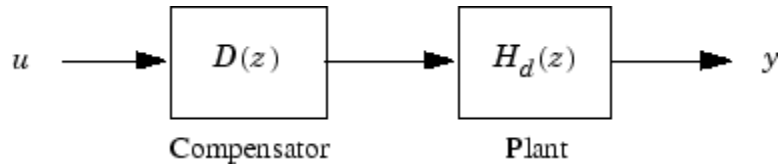

is obtained by the series connection

```

D = zpk(0.85,0,1,Ts)
olloop = Hd * D
  
```

Now see how this compensator modifies the open-loop frequency response.

```

bodeplot(Hd, '-',olloop, '-')
  
```

The plant response is the dashed line and the open-loop response with the compensator is the solid line.

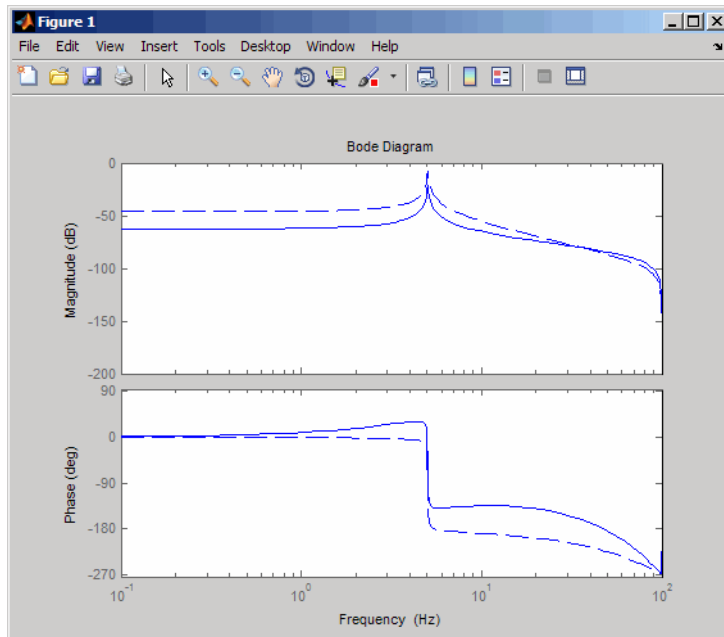

The plot above shows that the compensator has shifted up the phase plot (added lead) in the frequency range $\omega > 10$ rad/sec.

Now try the root locus again with the plant and compensator as open loop.

```
rlocus(olloop)
zgrid
```

Open the **Property Editor** by right-clicking in the plot away from the curve. On the **Limits** page, set the x - and y -axis limits from -1 to 1.01. This figure shows the result.

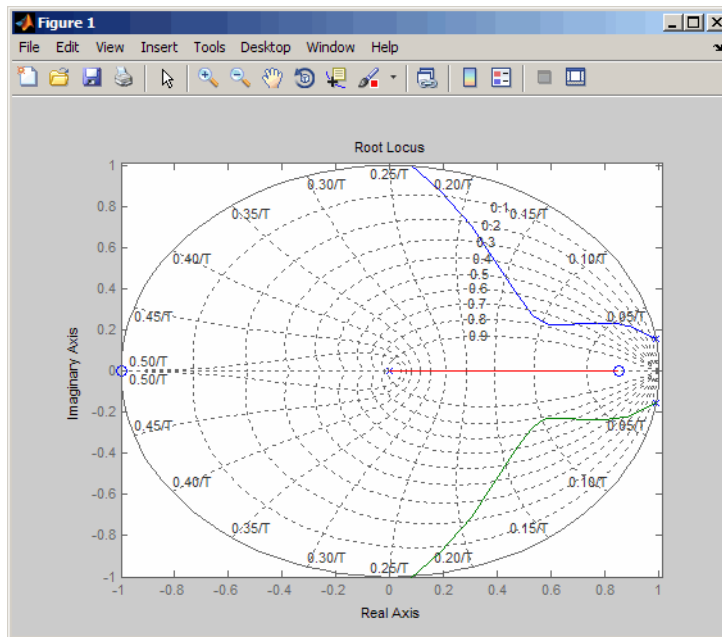

This time, the poles stay within the unit circle for some time (the lines drawn by `zgrid` show the damping ratios from $\zeta = 0$ to 1 in steps of 0.1). Use a data marker to find the point on the curve where the gain equals $4.111e+03$. This figure shows the data marker at the correct location.

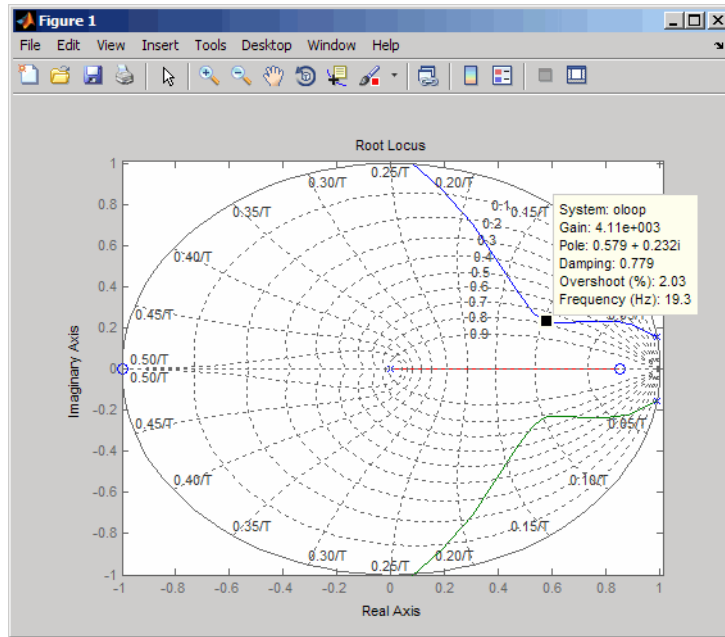

Design Analysis

To analyze this design, form the closed-loop system and plot the closed-loop step response.

```
K = 4.11e+03;
cloop = feedback(olloop,K);
step(cloop)
```

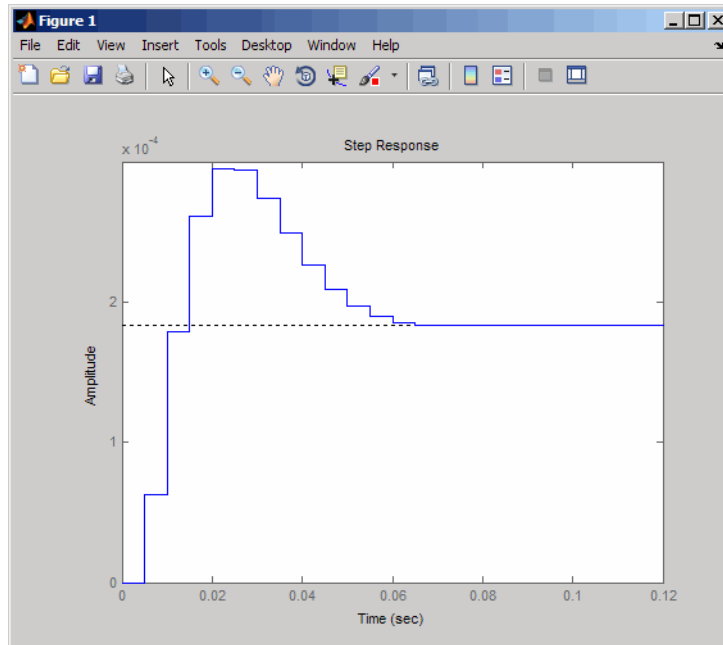

This response depends on your closed loop set point. The one shown here is relatively fast and settles in about 0.07 seconds. Therefore, this closed loop disk drive system has a seek time of about 0.07 seconds. This is slow by today's standards, but you also started with a very lightly damped system.

Now look at the robustness of your design. The most common classical robustness criteria are the gain and phase margins. Use the function `margin` to determine these margins. With output arguments, `margin` returns the gain and phase margins as well as the corresponding crossover frequencies. Without output argument, `margin` plots the Bode response and displays the margins graphically.

To compute the margins, first form the unity-feedback open loop by connecting the compensator $D(z)$, plant model, and feedback gain k in series.

```
olk = K * oloop;
```

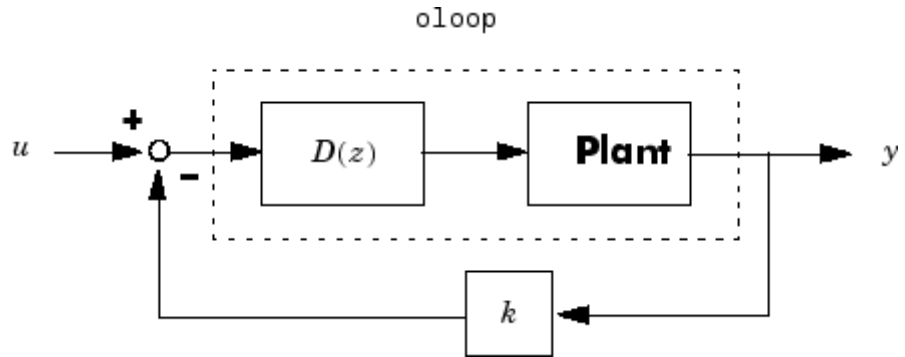

Next apply margin to this open-loop model. Type

```
[Gm,Pm,Wcg,Wcp] = margin(olk);
Margins = [Gm Wcg Pm Wcp]
Margins =
```

```
3.7987 296.7978 43.2031 106.2462
```

To obtain the gain margin in dB, type

```
20*log10(Gm)
ans =
11.5926
```

You can also display the margins graphically by typing

```
margin(olk)
```

The command produces the plot shown below.

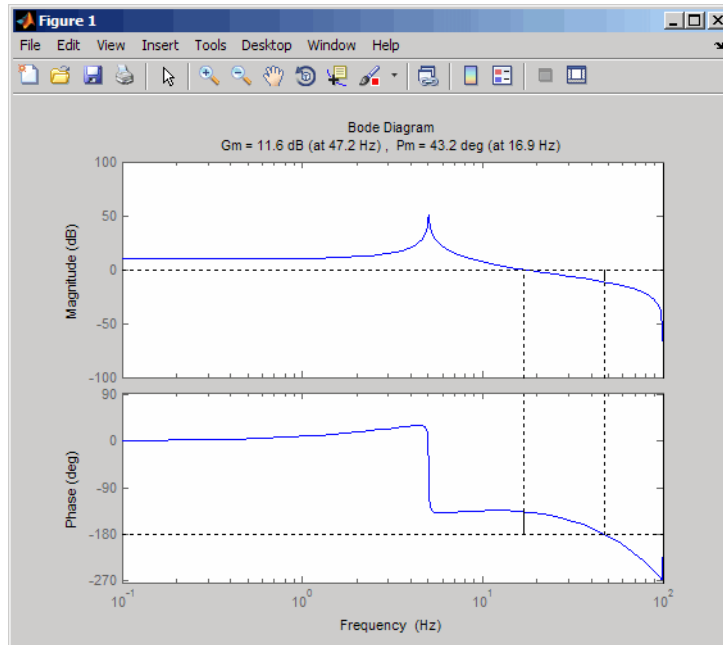

This design is robust and can tolerate a 11 dB gain increase or a 40 degree phase lag in the open-loop system without going unstable. By continuing this design process, you may be able to find a compensator that stabilizes the open-loop system and allows you to reduce the seek time.

LQG Regulation: Rolling Mill Case Study

In this section...
“Overview of this Case Study” on page 15-30
“Process and Disturbance Models” on page 15-30
“LQG Design for the x-Axis” on page 15-33
“LQG Design for the y-Axis” on page 15-40
“Cross-Coupling Between Axes” on page 15-42
“MIMO LQG Design” on page 15-45

Overview of this Case Study

This case study demonstrates the use of the LQG design tools in a process control application. The goal is to regulate the horizontal and vertical thickness of the beam produced by a hot steel rolling mill. This example is adapted from [1]. The full plant model is MIMO and the example shows the advantage of direct MIMO LQG design over separate SISO designs for each axis. Type

`milldemo`

at the command line to run this demonstration interactively.

Process and Disturbance Models

The rolling mill is used to shape rectangular beams of hot metal. The desired outgoing shape is sketched below.

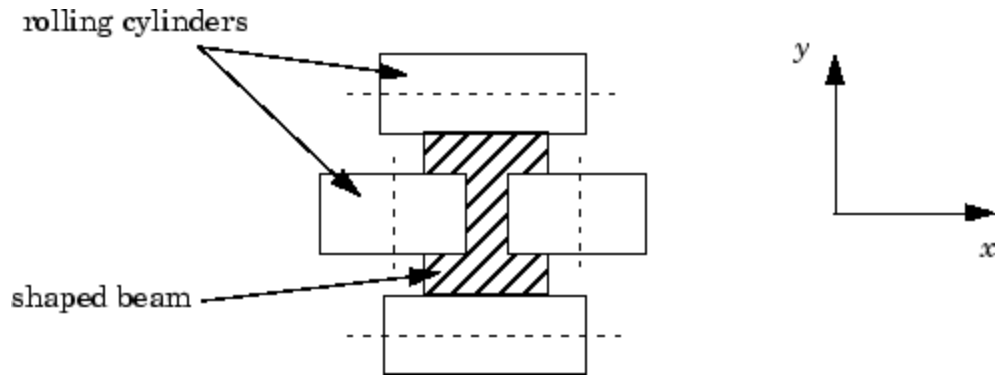

This shape is impressed by two pairs of rolling cylinders (one per axis) positioned by hydraulic actuators. The gap between the two cylinders is called the *roll gap*.

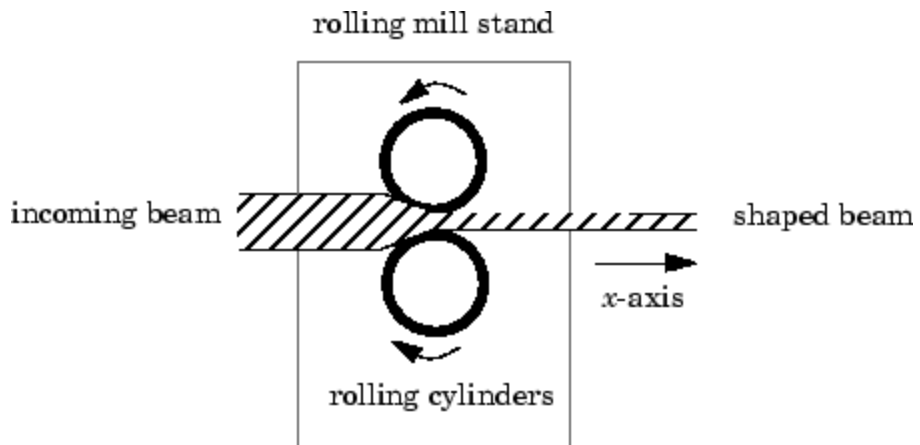

The objective is to maintain the beam thickness along the x - and y -axes within the quality assurance tolerances. Variations in output thickness can arise from the following:

- Variations in the thickness/hardness of the incoming beam
- Eccentricity in the rolling cylinders

Feedback control is necessary to reduce the effect of these disturbances. Because the roll gap cannot be measured close to the mill stand, the rolling force is used instead for feedback.

The input thickness disturbance is modeled as a low pass filter driven by white noise. The eccentricity disturbance is approximately periodic and its frequency is a function of the rolling speed. A reasonable model for this disturbance is a second-order bandpass filter driven by white noise.

This leads to the following generic model for each axis of the rolling process.

Open-loop Model for x- or y-axis

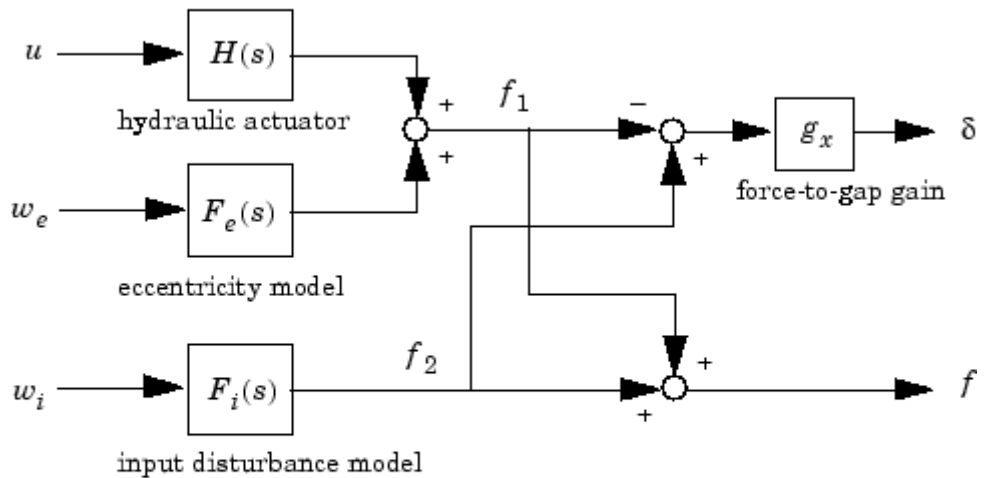

- u **command**
- δ **thickness gap (in mm)**
- f **incremental rolling force**
- w_i, w_e **driving white noise for disturbance models**

The measured rolling force variation f is a combination of the incremental force delivered by the hydraulic actuator and of the disturbance forces due to eccentricity and input thickness variation. Note that:

- The outputs of $H(s)$, $F_e(s)$, and $F_i(s)$ are the incremental forces delivered by each component.
- An increase in hydraulic or eccentricity force *reduces* the output thickness gap δ .
- An increase in input thickness *increases* this gap.

The model data for each axis is summarized below.

Model Data for the x-Axis

$$H_x(s) = \frac{2.4 \times 10^8}{s^2 + 72s + 90^2}$$

$$F_{ix}(s) = \frac{10^4}{s + 0.05}$$

$$F_{ex}(s) = \frac{3 \times 10^4 s}{s^2 + 0.125s + 6^2}$$

$$g_x = 10^{-6}$$

Model Data for the y-Axis

$$H_y(s) = \frac{7.8 \times 10^8}{s^2 + 71s + 88^2}$$

$$F_{iy}(s) = \frac{2 \times 10^4}{s + 0.05}$$

$$F_{ey}(s) = \frac{10^5 s}{s^2 + 0.19s + 9.4^2}$$

$$g_y = 0.5 \times 10^{-6}$$

LQG Design for the x-Axis

As a first approximation, ignore the cross-coupling between the x- and y-axes and treat each axis independently. That is, design one SISO LQG regulator

for each axis. The design objective is to reduce the thickness variations δ_x and δ_y due to eccentricity and input thickness disturbances.

Start with the x -axis. First specify the model components as transfer function objects.

```
% Hydraulic actuator (with input "u-x")
Hx = tf(2.4e8,[1 72 90^2],'inputname','u-x')

% Input thickness/hardness disturbance model
Fix = tf(1e4,[1 0.05],'inputn','w-ix')

% Rolling eccentricity model
Fex = tf([3e4 0],[1 0.125 6^2],'inputn','w-ex')

% Gain from force to thickness gap
gx = 1e-6;
```

Next build the open-loop model shown in “Process and Disturbance Models” on page 15-30. You could use the function `connect` for this purpose, but it is easier to build this model by elementary `append` and `series` connections.

```
% I/O map from inputs to forces f1 and f2
Px = append([ss(Hx) Fex],Fix)

% Add static gain from f1,f2 to outputs "x-gap" and "x-force"
Px = [-gx gx;1 1] * Px

% Give names to the outputs:
set(Px,'outputn',{'x-gap' 'x-force'})
```

Note To obtain minimal state-space realizations, always convert transfer function models to state space *before* connecting them. Combining transfer functions and then converting to state space may produce nonminimal state-space models.

The variable `Px` now contains an open-loop state-space model complete with input and output names.

```
Px.inputname
```

```
ans =
    'u-x'
    'w-ex'
    'w-ix'
```

```
Px.outputname
```

```
ans =
    'x-gap'
    'x-force'
```

The second output 'x-force' is the rolling force measurement. The LQG regulator will use this measurement to drive the hydraulic actuator and reduce disturbance-induced thickness variations δ_x .

The LQG design involves two steps:

- 1 Design a full-state-feedback gain that minimizes an LQ performance measure of the form

$$J(u_x) = \int_0^{\infty} \{q\delta_x^2 + ru_x^2\} dt$$

- 2 Design a Kalman filter that estimates the state vector given the force measurements 'x-force'.

The performance criterion $J(u_x)$ penalizes low and high frequencies equally. Because low-frequency variations are of primary concern, eliminate the high-frequency content of δ_x with the low-pass filter $30/(s + 30)$ and use the filtered value in the LQ performance criterion.

```
lpf = tf(30,[1 30])
```

```
% Connect low-pass filter to first output of Px
Pxdes = append(lpf,1) * Px
set(Pxdes,'outputn',{'x-gap*' 'x-force'})
```

```
% Design the state-feedback gain using LQRY and q=1, r=1e-4
```

```
kx = lqry(Pxdes(1,1),1,1e-4)
```

Note `lqry` expects all inputs to be commands and all outputs to be measurements. Here the command 'u-x' and the measurement 'x-gap*' (filtered gap) are the first input and first output of `Pxdes`. Hence, use the syntax `Pxdes(1,1)` to specify just the I/O relation between 'u-x' and 'x-gap*'.

Next, design the Kalman estimator with the function `kalman`. The process noise

$$w_x = \begin{bmatrix} w_{ex} \\ w_{ix} \end{bmatrix}$$

has unit covariance by construction. Set the measurement noise covariance to 1000 to limit the high frequency gain, and keep only the measured output 'x-force' for estimator design.

```
estx = kalman(Pxdes(2,:),eye(2),1000)
```

Finally, connect the state-feedback gain `kx` and state estimator `estx` to form the LQG regulator.

```
Regx = lqgreg(estx,kx)
```

This completes the LQG design for the x -axis.

Let's look at the regulator Bode response between 0.1 and 1000 rad/sec.

```
h = bodeplot(Regx,{0.1 1000})  
setoptions(h,'PhaseMatching','on')
```

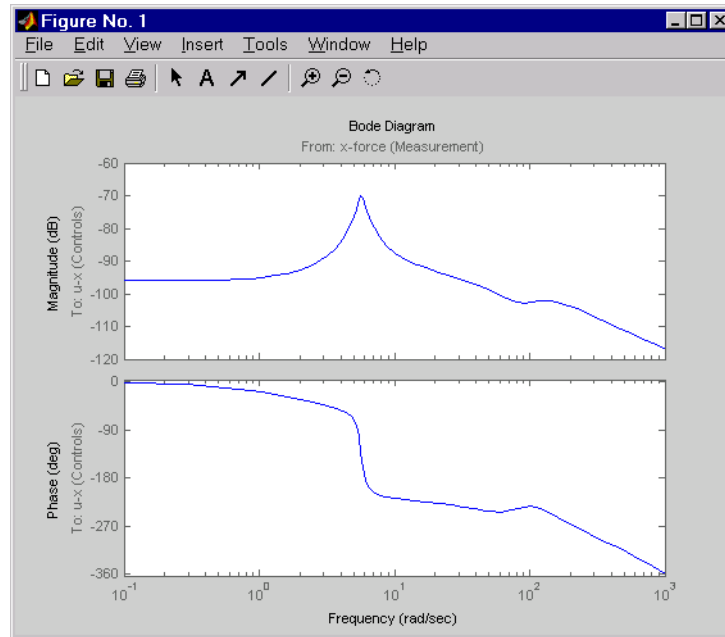
The phase response has an interesting physical interpretation. First, consider an increase in input thickness. This low-frequency disturbance boosts both output thickness and rolling force. Because the regulator phase is approximately 0° at low frequencies, the feedback loop then adequately reacts by increasing the hydraulic force to offset the thickness increase. Now consider the effect of eccentricity. Eccentricity causes fluctuations in the roll gap (gap between the rolling cylinders). When the roll gap is minimal, the rolling force increases and the beam thickness diminishes. The hydraulic force must then be reduced (negative force feedback) to restore the desired thickness. This is exactly what the LQG regulator does as its phase drops to -180° near the natural frequency of the eccentricity disturbance (6 rad/sec).

Next, compare the open- and closed-loop responses from disturbance to thickness gap. Use `feedback` to close the loop. To help specify the feedback connection, look at the I/O names of the plant `Px` and regulator `Regx`.

```
Px.inputname
ans =
    'u-x'
```

```
'w-ex'  
'w-ix'
```

```
Regx.outputname  
ans =  
'u-x'
```

```
Px.outputname  
ans =  
'x-gap'  
'x-force'
```

```
Regx.inputname  
ans =  
'x-force'
```

This indicates that you must connect the first input and second output of Px to the regulator.

```
clx = feedback(Px,Regx,1,2,+1) % Note: +1 for positive feedback
```

You are now ready to compare the open- and closed-loop Bode responses from disturbance to thickness gap.

```
h = bodeplot(Px(1,2:3),'--',clx(1,2:3),'-',{0.1 100})  
setoptions(h,'PhaseMatching','on')
```

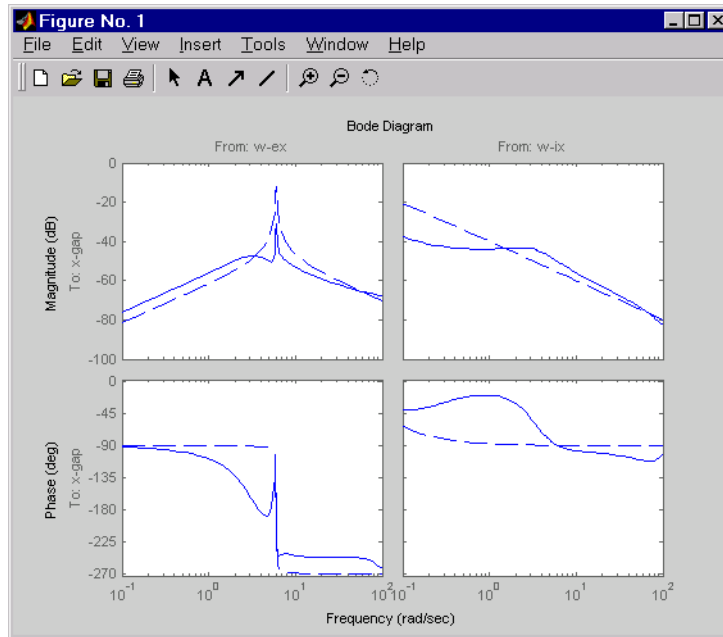

The dashed lines show the open-loop response. Note that the peak gain of the eccentricity-to-gap response and the low-frequency gain of the input-thickness-to-gap response have been reduced by about 20 dB.

Finally, use `lsim` to simulate the open- and closed-loop time responses to the white noise inputs w_{ex} and w_{ix} . Choose $dt=0.01$ as sampling period for the simulation, and derive equivalent discrete white noise inputs for this sampling rate.

```
dt = 0.01
t = 0:dt:50    % time samples

% Generate unit-covariance driving noise wx = [w-ex;w-ix].
% Equivalent discrete covariance is 1/dt
wx = sqrt(1/dt) * randn(2,length(t))

lsim(Px(1,2:3), ':', clx(1,2:3), '-', wx, t)
```

Right-click on the plot that appears and select **Show Input** to turn off the display of the input.

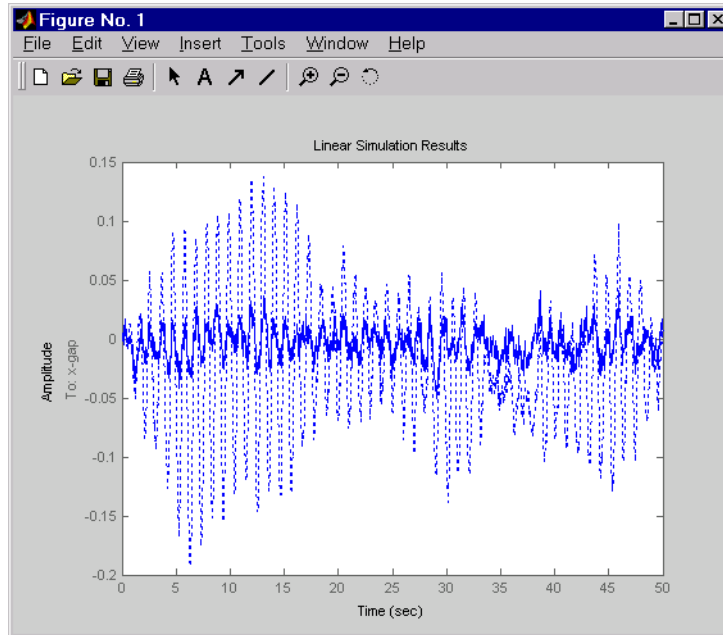

The dotted lines correspond to the open-loop response. In this simulation, the LQG regulation reduces the peak thickness variation by a factor 4.

LQG Design for the y-Axis

The LQG design for the y-axis (regulation of the y thickness) follows the exact same steps as for the x-axis.

```
% Specify model components
Hy = tf(7.8e8,[1 71 88^2],'inputn','u-y')
Fiy = tf(2e4,[1 0.05],'inputn','w-iy')
Fey = tf([1e5 0],[1 0.19 9.4^2],'inputn','w-ey')
gy = 0.5e-6 % force-to-gap gain
```

```
% Build open-loop model
Py = append([ss(Hy) Fey],Fiy)
```

```
Py = [-gy gy;1 1] * Py
set(Py,'outputn',{'y-gap' 'y-force'})

% State-feedback gain design
Pydes = append(lpf,1) * Py % Add low-freq. weighing
set(Pydes,'outputn',{'y-gap*' 'y-force'})
ky = lqry(Pydes(1,1),1,1e-4)

% Kalman estimator design
esty = kalman(Pydes(2,:),eye(2),1e3)

% Form SISO LQG regulator for y-axis and close the loop
Regy = lqgreg(esty,ky)
cly = feedback(Py,Regy,1,2,+1)
```

Compare the open- and closed-loop response to the white noise input disturbances.

```
dt = 0.01
t = 0:dt:50
wy = sqrt(1/dt) * randn(2,length(t))

lsim(Py(1,2:3),':',cly(1,2:3),'-',wy,t)
```

Right-click on the plot that appears and select **Show Input** to turn off the display of the input.

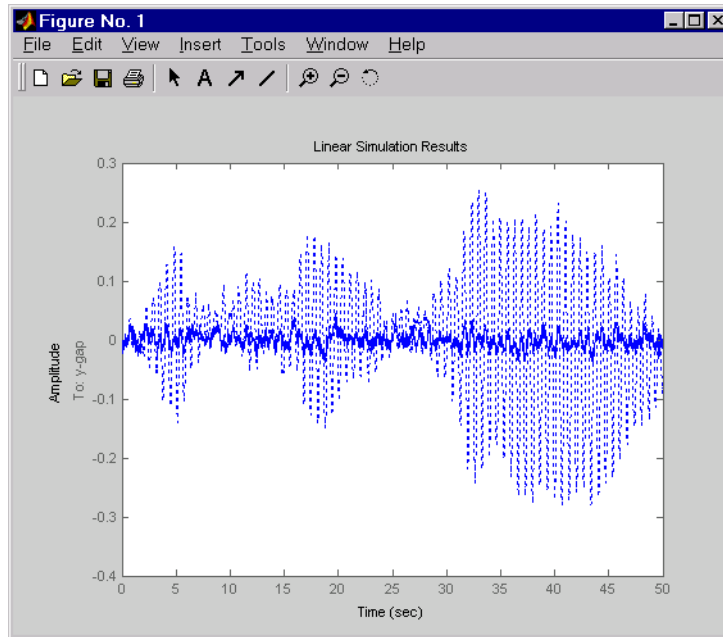

The dotted lines correspond to the open-loop response. The simulation results are comparable to those for the x -axis.

Cross-Coupling Between Axes

The x/y thickness regulation, is a MIMO problem. So far you have treated each axis separately and closed one SISO loop at a time. This design is valid as long as the two axes are fairly decoupled. Unfortunately, this rolling mill process exhibits some degree of cross-coupling between axes. Physically, an increase in hydraulic force along the x -axis compresses the material, which in turn boosts the repelling force on the y -axis cylinders. The result is an increase in y -thickness and an equivalent (relative) decrease in hydraulic force along the y -axis.

The figure below shows the coupling.

Coupling Between the x- and y-axes

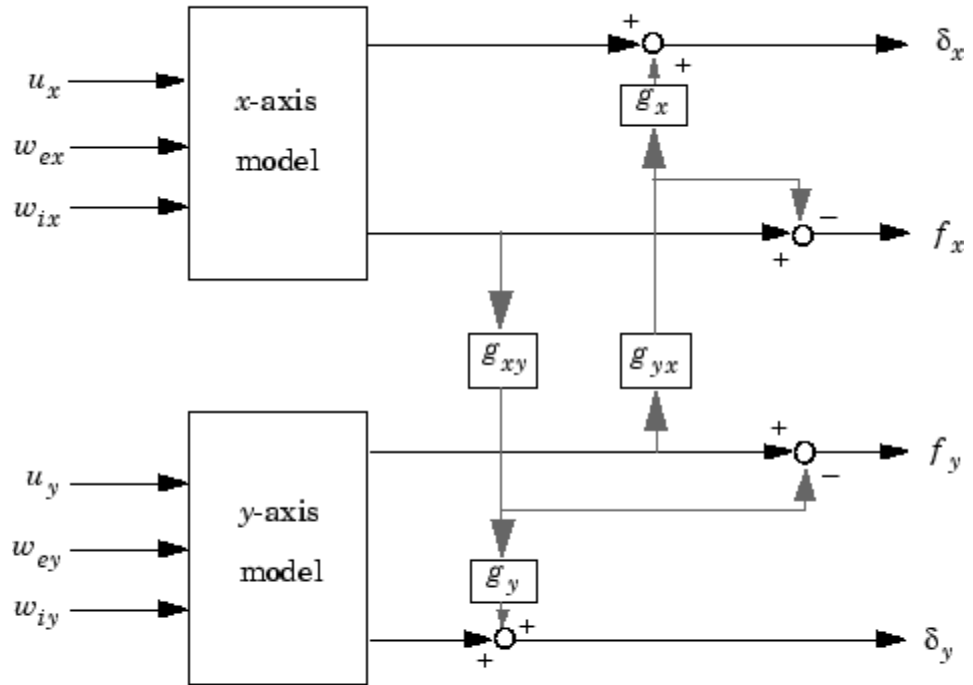

$$g_{xy} = 0.1$$

$$g_{yx} = 0.4$$

Accordingly, the thickness gaps and rolling forces are related to the outputs $\bar{\delta}_x, \bar{f}_x, \dots$ of the x- and y-axis models by

$$\begin{bmatrix} \delta_x \\ \delta_y \\ f_x \\ f_x \end{bmatrix} = \underbrace{\begin{bmatrix} 1 & 0 & 0 & g_{yx}g_x \\ 0 & 1 & g_{xy}g_y & 0 \\ 0 & 0 & 1 & -g_{yx} \\ 0 & 0 & -g_{xy} & 1 \end{bmatrix}}_{\text{cross-coupling matrix}} \begin{bmatrix} \bar{\delta}_x \\ \bar{\delta}_y \\ \bar{f}_x \\ \bar{f}_y \end{bmatrix}$$

Let's see how the previous "decoupled" LQG design fares when cross-coupling is taken into account. To build the two-axes model, shown above, append the models Px and Py for the x- and y-axes.

```
P = append(Px,Py)
```

For convenience, reorder the inputs and outputs so that the commands and thickness gaps appear first.

```
P = P([1 3 2 4],[1 4 2 3 5 6])
P.outputname
```

```
ans =
    'x-gap'
    'y-gap'
    'x-force'
    'y-force'
```

Finally, place the cross-coupling matrix in series with the outputs.

```
gxy = 0.1; gyx = 0.4;
CCmat = [eye(2) [0 gyx*gx;gxy*gy 0] ; zeros(2) [1 -gyx;-gxy 1]]
Pc = CCmat * P
Pc.outputname = P.outputname
```

To simulate the closed-loop response, also form the closed-loop model by

```
feedin = 1:2 % first two inputs of Pc are the commands
feedout = 3:4 % last two outputs of Pc are the measurements
cl = feedback(Pc,append(Regx,Regy),feedin,feedout,+1)
```

You are now ready to simulate the open- and closed-loop responses to the driving white noises wx (for the x-axis) and wy (for the y-axis).

```
wxy = [wx ; wy]
lsim(Pc(1:2,3:6), ':-', cl(1:2,3:6), ':-', wxy, t)
```

Right-click on the plot that appears and select **Show Input** to turn off the display of the input.

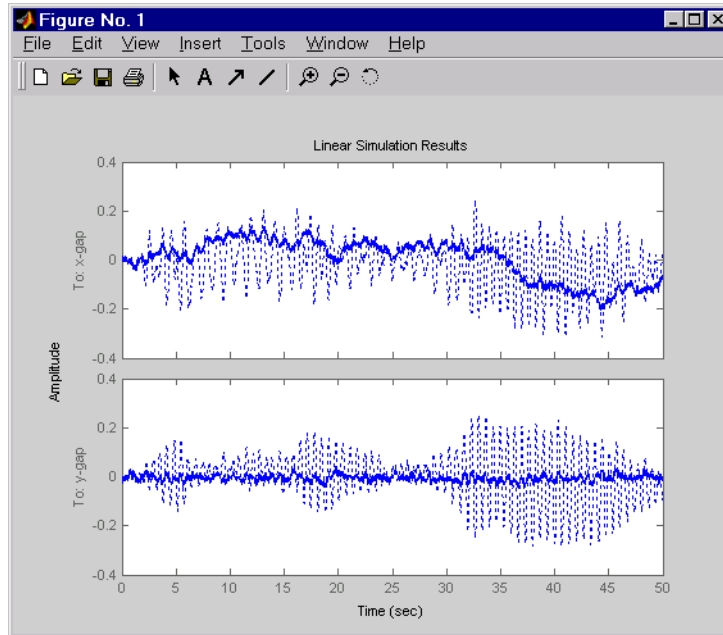

The response reveals a severe deterioration in regulation performance along the x -axis (the peak thickness variation is about four times larger than in the simulation without cross-coupling). Hence, designing for one loop at a time is inadequate for this level of cross-coupling, and you must perform a joint-axis MIMO design to correctly handle coupling effects.

MIMO LQG Design

Start with the complete two-axis state-panespace model P_c derived in “Cross-Coupling Between Axes” on page 15-42. The model inputs and outputs are

```
Pc.inputname
```

```
ans =  
    'u-x'  
    'u-y'  
    'w-ex'  
    'w-ix'  
    'w_ey'  
    'w_iy'
```

```
P.outputname
```

```
ans =  
    'x-gap'  
    'y-gap'  
    'x-force'  
    'y-force'
```

As earlier, add low-pass filters in series with the 'x-gap' and 'y-gap' outputs to penalize only low-frequency thickness variations.

```
Pdes = append(lpf,lpf,eye(2)) * Pc  
Pdes.outputn = Pc.outputn
```

Next, design the LQ gain and state estimator as before (there are now two commands and two measurements).

```
k = lqry(Pdes(1:2,1:2),eye(2),1e-4*eye(2))    % LQ gain  
est = kalman(Pdes(3:4,:),eye(4),1e3*eye(2))  % Kalman estimator
```

```
RegMIMO = lqgreg(est,k)    % form MIMO LQG regulator
```

The resulting LQG regulator RegMIMO has two inputs and two outputs.

```
RegMIMO.inputname
```

```
ans =  
    'x-force'  
    'y-force'
```

```
RegMIMO.outputname
```

```
ans =
    'u-x'
    'u-y'
```

Plot its singular value response (principal gains).

```
sigma(RegMIMO)
```

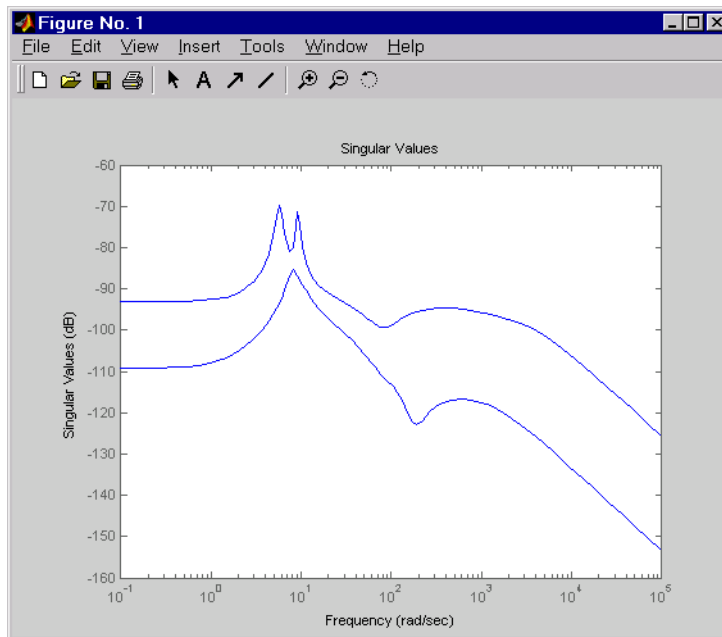

Next, plot the open- and closed-loop time responses to the white noise inputs (using the MIMO LQG regulator for feedback).

```
% Form the closed-loop model
cl = feedback(Pc,RegMIMO,1:2,3:4,+1);

% Simulate with lsim using same noise inputs
lsim(Pc(1:2,3:6),':',cl(1:2,3:6),'-',wxy,t)
```

Right-click on the plot that appears and select **Show Input** to turn off the display of the input.

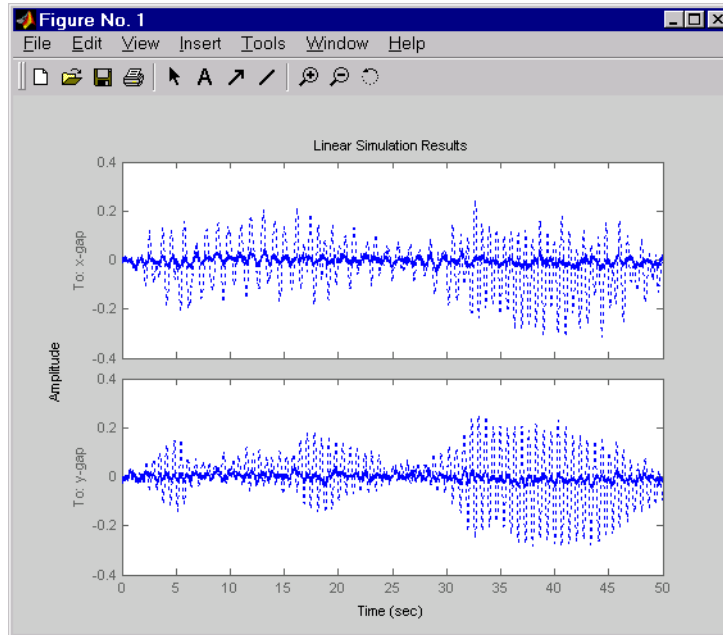

The MIMO design is a clear improvement over the separate SISO designs for each axis. In particular, the level of x/y thickness variation is now comparable to that obtained in the decoupled case. This example illustrates the benefits of direct MIMO design for multivariable systems.

Kalman Filtering

In this section...

“Overview of this Case Study” on page 15-49

“Discrete Kalman Filter” on page 15-50

“Steady-State Design” on page 15-51

“Time-Varying Kalman Filter” on page 15-57

“Time-Varying Design” on page 15-58

“References” on page 15-62

Overview of this Case Study

This final case study illustrates Kalman filter design and simulation. Both steady-state and time-varying Kalman filters are considered.

Consider the discrete plant

$$\begin{aligned}x[n+1] &= Ax[n] + B(u[n] + w[n]) \\ y[n] &= Cx[n]\end{aligned}$$

with additive Gaussian noise $w[n]$ on the input $u[n]$ and data

$$A = \begin{bmatrix} 1.1269 & -0.4940 & 0.1129 \\ 1.0000 & 0 & 0 \\ 0 & 1.0000 & 0 \end{bmatrix};$$

$$B = \begin{bmatrix} -0.3832 \\ 0.5919 \\ 0.5191 \end{bmatrix};$$

$$C = [1 \ 0 \ 0];$$

Our goal is to design a Kalman filter that estimates the output $y[n]$ given the inputs $u[n]$ and the noisy output measurements

$$y_v[n] = Cx[n] + v[n]$$

where $v[n]$ is some Gaussian white noise.

Discrete Kalman Filter

The equations of the steady-state Kalman filter for this problem are given as follows.

Measurement update

$$\hat{x}[n|n] = \hat{x}[n|n-1] + M(y_v[n] - C\hat{x}[n|n-1])$$

Time update

$$\hat{x}[n+1|n] = A\hat{x}[n|n] + Bu[n]$$

In these equations:

- $\hat{x}[n|n-1]$ is the estimate of $x[n]$ given past measurements up to $y_v[n-1]$
- $\hat{x}[n|n]$ is the updated estimate based on the last measurement $y_v[n]$

Given the current estimate $\hat{x}[n|n]$, the time update predicts the state value at the next sample $n+1$ (one-step-ahead predictor). The measurement update then adjusts this prediction based on the new measurement $y_v[n+1]$. The correction term is a function of the *innovation*, that is, the discrepancy.

$$y_v[n+1] - C\hat{x}[n+1|n]$$

between the measured and predicted values of $y[n+1]$. The innovation gain M is chosen to minimize the steady-state covariance of the estimation error given the noise covariances

$$E(w[n]w[n]^T) = Q \quad E(v[n]v[n]^T) = R \quad N = E(w[n]v[n]^T) = 0$$

You can combine the time and measurement update equations into one state-space model (the Kalman filter).

$$\hat{x}[n+1|n] = A(I - MC)\hat{x}[n|n-1] + [B \quad AM] \begin{bmatrix} u[n] \\ y_v[n] \end{bmatrix}$$

$$\hat{y}[n|n] = C(I - MC)\hat{x}[n|n-1] + CM y_v[n]$$

This filter generates an optimal estimate $\hat{y}[n|n]$ of $y[n]$. Note that the filter state is $\hat{x}[n|n-1]$.

Steady-State Design

You can design the steady-state Kalman filter described above with the function `kalman`. First specify the plant model with the process noise.

$$x[n+1] = Ax[n] + Bu[n] + Bw[n] \quad (\text{state equation})$$

$$y[n] = Cx[n] \quad (\text{measurement equation})$$

This is done by

```
% Note: set sample time to -1 to mark model as discrete
Plant = ss(A,[B B],C,0,-1,'inputname',{ 'u' 'w'},...
           'outputname','y');
```

Assuming that $Q = R = 1$, you can now design the discrete Kalman filter by

```
Q = 1; R = 1;
[kalmf,L,P,M] = kalman(Plant,Q,R);
```

This returns a state-space model `kalmf` of the filter as well as the innovation gain

M

M =

0.3798

0.0817
-0.2570

The inputs of `kalmf` are u and y_v , and its outputs are the plant output and state estimates $y_e = \hat{y}[n|n]$ and $\hat{x}[n|n]$.

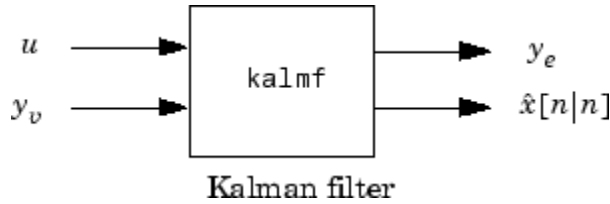

Because you are interested in the output estimate y_e , keep only the first output of `kalmf`. Type

```

kalmf = kalmf(1,:);
kalmf
a =
           x1_e    x2_e    x3_e
x1_e    0.7683   -0.494    0.1129
x2_e    0.6202         0         0
x3_e   -0.08173         1         0

b =
           u        y
x1_e   -0.3832    0.3586
x2_e    0.5919    0.3798
x3_e    0.5191    0.08173

c =
           x1_e    x2_e    x3_e
y_e    0.6202         0         0

d =
           u        y
y_e     0    0.3798
  
```

Input groups:
Name Channels

```

KnownInput      1
Measurement     2

```

```

Output groups:
  Name          Channels
OutputEstimate    1

```

```

Sampling time: unspecified
Discrete-time model.

```

To see how the filter works, generate some input data and random noise and compare the filtered response y_e with the true response y . You can either generate each response separately, or generate both together. To simulate each response separately, use `lsim` with the plant alone first, and then with the plant and filter hooked up together. The joint simulation alternative is detailed next.

The block diagram below shows how to generate both true and filtered outputs.

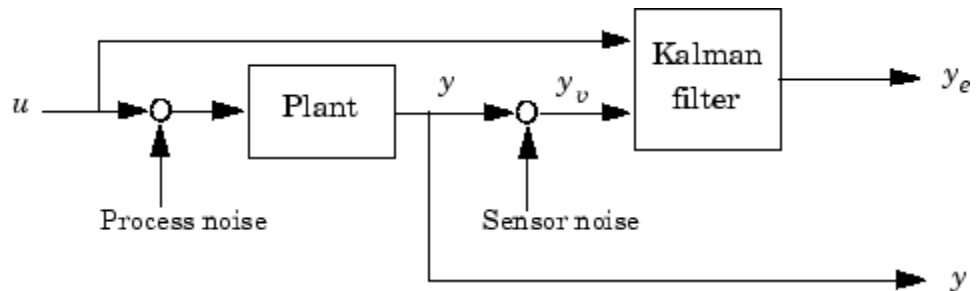

You can construct a state-space model of this block diagram with the functions `parallel` and `feedback`. First build a complete plant model with u , w , v as inputs y and y_v (measurements) as outputs.

```

a = A;
b = [B B 0*B];
c = [C;C];
d = [0 0 0;0 0 1];
P = ss(a,b,c,d,-1,'inputname',{'u' 'w' 'v'},...
'outputname',{'y' 'yv'});

```

Then use `parallel` to form the following parallel connection.

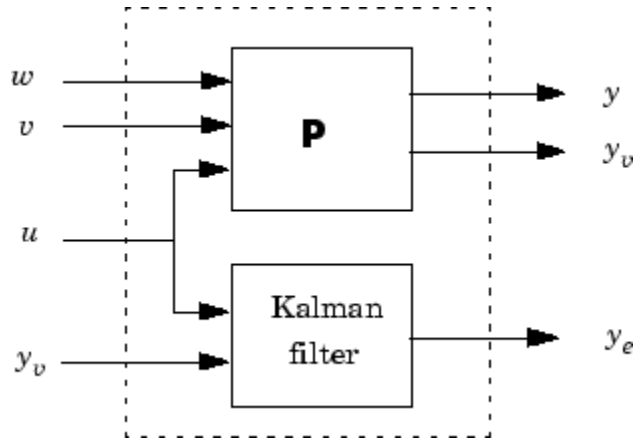

```
sys = parallel(P,kalmf,1,1,[],[])
```

Finally, close the sensor loop by connecting the plant output y_v to the filter input y_v with positive feedback.

```
% Close loop around input #4 and output #2
SimModel = feedback(sys,1,4,2,1)
% Delete yv from I/O list
SimModel = SimModel([1 3],[1 2 3])
```

The resulting simulation model has w , v , u as inputs and y , y_e as outputs.

```
SimModel.inputname
```

```
ans =
    'w'
    'v'
    'u'
```

```
SimModel.outputname
```

```
ans =
    'y'
    'y_e'
```

You are now ready to simulate the filter behavior. Generate a sinusoidal input u and process and measurement noise vectors w and v .

```
t = [0:100]';  
u = sin(t/5);  
  
n = length(t)  
randn('seed',0)  
w = sqrt(Q)*randn(n,1);  
v = sqrt(R)*randn(n,1);
```

Now simulate with `lsim`.

```
[out,x] = lsim(SimModel,[w,v,u]);  
  
y = out(:,1); % true response  
ye = out(:,2); % filtered response  
yv = y + v; % measured response
```

and compare the true and filtered responses graphically.

```
subplot(211), plot(t,y,'--',t,ye,'-'),  
xlabel('No. of samples'), ylabel('Output')  
title('Kalman filter response')  
subplot(212), plot(t,y-yv,'-.',t,y-ye,'-'),  
xlabel('No. of samples'), ylabel('Error')
```

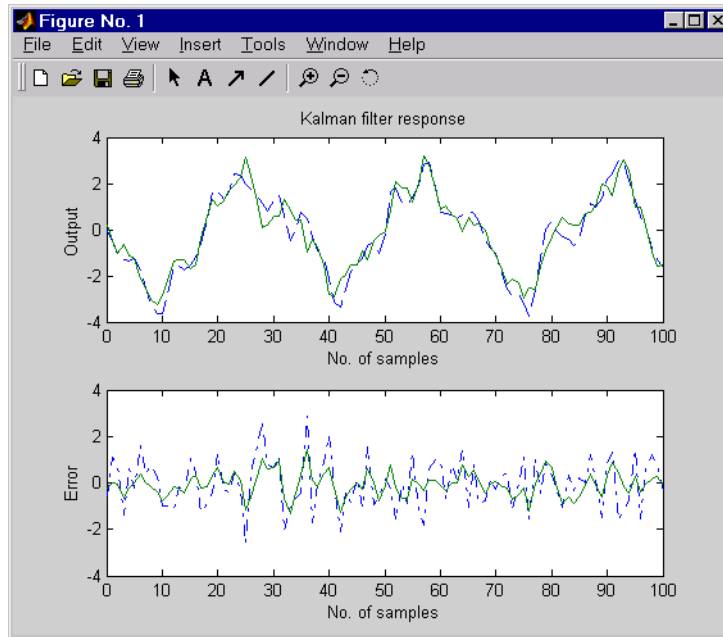

The first plot shows the true response y (dashed line) and the filtered output y_e (solid line). The second plot compares the measurement error (dash-dot) with the estimation error (solid). This plot shows that the noise level has been significantly reduced. This is confirmed by the following error covariance computations.

```
MeasErr = y-yv;
MeasErrCov = sum(MeasErr.*MeasErr)/length(MeasErr);
EstErr = y-ye;
EstErrCov = sum(EstErr.*EstErr)/length(EstErr);
```

The error covariance before filtering (measurement error) is

```
MeasErrCov
```

```
MeasErrCov =
    1.1138
```

while the error covariance after filtering (estimation error) is only

EstErrCov

EstErrCov =
0.2722

Time-Varying Kalman Filter

The time-varying Kalman filter is a generalization of the steady-state filter for time-varying systems or LTI systems with nonstationary noise covariance. Given the plant state and measurement equations

$$\begin{aligned}x[n+1] &= Ax[n] + Bu[n] + Gw[n] \\y_v[n] &= Cx[n] + v[n]\end{aligned}$$

the time-varying Kalman filter is given by the recursions

Measurement update

$$\begin{aligned}\hat{x}[n|n] &= \hat{x}[n|n-1] + M[n](y_v[n] - C\hat{x}[n|n-1]) \\M[n] &= P[n|n-1]C^T(R[n] + CP[n|n-1]C^T)^{-1} \\P[n|n] &= (I - M[n]C)P[n|n-1]\end{aligned}$$

Time update

$$\begin{aligned}\hat{x}[n+1|n] &= A\hat{x}[n|n] + Bu[n] \\P[n+1|n] &= AP[n|n]A^T + GQ[n]G^T\end{aligned}$$

with $\hat{x}[n|n-1]$ and $\hat{x}[n|n]$ as defined in “Discrete Kalman Filter” on page 15-50, and in the following.

$$Q[n] = E(w[n]w[n]^T)$$

$$R[n] = E(v[n]v[n]^T)$$

$$P[n|n] = E(\{x[n] - x[n|n]\}\{x[n] - x[n|n]\}^T)$$

$$P[n|n-1] = E(\{x[n] - x[n|n-1]\}\{x[n] - x[n|n-1]\}^T)$$

For simplicity, we have dropped the subscripts indicating the time dependence of the state-space matrices.

Given initial conditions $x[1|0]$ and $P[1|0]$, you can iterate these equations to perform the filtering. Note that you must update both the state estimates

$x[n|.]$ and error covariance matrices $P[n|.]$ at each time sample.

Time-Varying Design

Although the Control System Toolbox software does not offer specific commands to perform time-varying Kalman filtering, it is easy to implement the filter recursions in the MATLAB environment. This section shows how to do this for the stationary plant considered above.

First generate noisy output measurements

```
% Use process noise w and measurement noise v generated above
sys = ss(A,B,C,0,-1);
y = lsim(sys,u+w);      % w = process noise
yv = y + v;            % v = measurement noise
```

Given the initial conditions

$$x[1|0] = 0, \quad P[1|0] = BQB^T$$

you can implement the time-varying filter with the following for loop.

```
P = B*Q*B';          % Initial error covariance
x = zeros(3,1);      % Initial condition on the state
ye = zeros(length(t),1);
ycov = zeros(length(t),1);
```

```

for i=1:length(t)
    % Measurement update
    Mn = P*C' / (C*P*C'+R);
    x = x + Mn*(yv(i)-C*x);    % x[n|n]
    P = (eye(3)-Mn*C)*P;      % P[n|n]

    ye(i) = C*x;
    errcov(i) = C*P*C';

    % Time update
    x = A*x + B*u(i);         % x[n+1|n]
    P = A*P*A' + B*Q*B';      % P[n+1|n]
end

```

You can now compare the true and estimated output graphically.

```

subplot(211), plot(t,y,'--',t,ye,'-')
title('Time-varying Kalman filter response')
xlabel('No. of samples'), ylabel('Output')
subplot(212), plot(t,y-yv,'-.',t,y-ye,'-')
xlabel('No. of samples'), ylabel('Output')

```

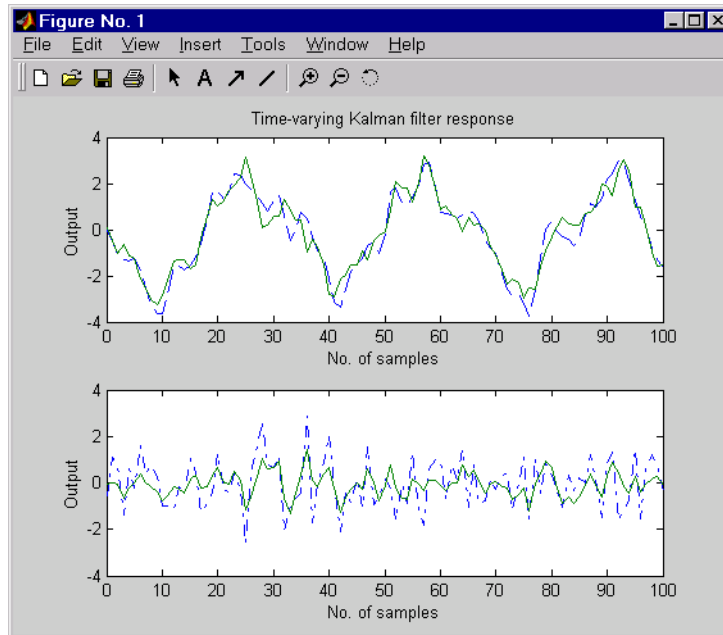

The first plot shows the true response y (dashed line) and the filtered response y_e (solid line). The second plot compares the measurement error (dash-dot) with the estimation error (solid).

The time-varying filter also estimates the covariance `errcov` of the estimation error $y - y_e$ at each sample. Plot it to see if your filter reached steady state (as you expect with stationary input noise).

```
subplot(211)
plot(t,errcov), ylabel('Error covar')
```

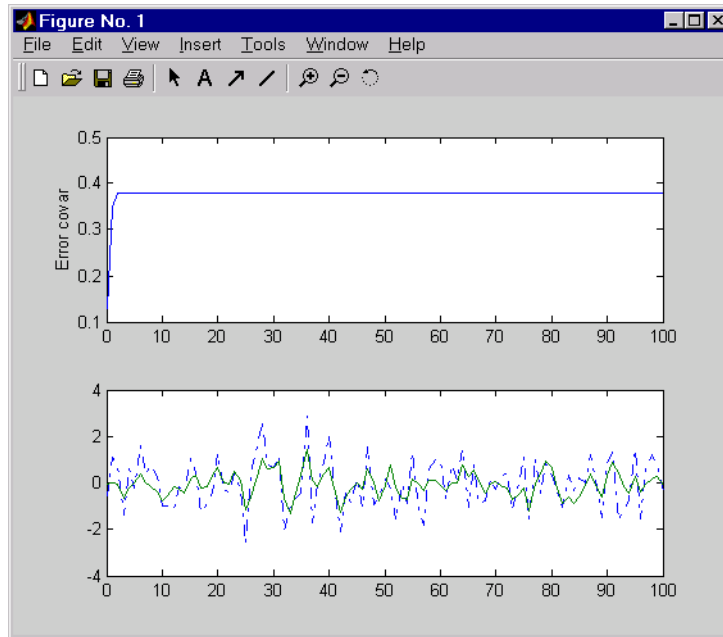
From this covariance plot, you can see that the output covariance did indeed reach a steady state in about five samples. From then on, your time-varying filter has the same performance as the steady-state version.

Compare with the estimation error covariance derived from the experimental data. Type

```
EstErr = y-ye;
EstErrCov = sum(EstErr.*EstErr)/length(EstErr)
EstErrCov =
    0.2718
```

This value is smaller than the theoretical value `errcov` and close to the value obtained for the steady-state design.

Finally, note that the final value $M[n]$ and the steady-state value M of the innovation gain matrix coincide.

M_n , M

Mn =
0.3798
0.0817
-0.2570

M =
0.3798
0.0817
-0.2570

References

[1] [Grimble, M.J., *Robust Industrial Control: Optimal Design Approach for Polynomial Systems*, Prentice Hall, 1994, p. 261 and pp. 443-456.

Reliable Computations

Scaling State-Space Models

In this section...
“Why Scaling Is Important” on page 16-2
“When to Scale Your Model” on page 16-2
“Manually Scaling Your Model” on page 16-3

Why Scaling Is Important

When working with state-space models, proper scaling is important for accurate computations. A state-space model is well scaled when the following conditions exist:

- The entries of the A , B , and C matrices are homogenous in magnitude.
- The model characteristics are insensitive to small perturbations in A , B , and C (in comparison to their norms).

Working with poorly scaled models can cause your model a severe loss of accuracy and puzzling results. An example of a poorly scaled model is a dynamic system with two states in the state vector that have units of light years and millimeters. Such disparate units may introduce both very large and very small entries into the A matrix. Over the course of computations, this mix of small and large entries in the matrix could destroy important characteristics of the model and lead to incorrect results.

For more information on the harmful affects of a poorly scaled model, see [Scaling Models to Maximize Accuracy](#).

When to Scale Your Model

You can avoid scaling issues altogether by carefully selecting units to reduce the spread between small and large coefficients.

In general, you do not have to perform your own scaling when using the Control System Toolbox software. The algorithms automatically scale your model to prevent loss of accuracy. The automated scaling chooses a frequency range to maximize accuracy based on the dominant dynamics of the model.

In most cases, automated scaling provides high accuracy without your intervention. For some models with dynamics spanning a wide frequency range, however, it is impossible to achieve good accuracy at *all* frequencies and some tradeoff of accuracy in different frequency bands is necessary. In such cases, a warning alerts you of potential inaccuracies. If you receive this warning, evaluate the tradeoffs and consider manually adjusting the frequency interval where you most need high accuracy. For information on how to manually scale your model, see “Manually Scaling Your Model” on page 16-3.

Note For models with satisfactory scaling, you can bypass automated scaling in the Control System Toolbox software. To do so, set the `Scaled` property of your state-space model to 1 (true). For information on how to set this property, see the `set` reference page.

Manually Scaling Your Model

If automatic scaling produces a warning, you can use the `prescale` command to manually scale your model and adjust the frequency interval where you most need high accuracy.

The `prescale` command includes a Scaling Tool GUI, which you can use to visualize accuracy tradeoffs and to adjust the frequency interval where this accuracy is maximized.

To scale your model using the Scaling Tool GUI, you perform the following steps:

- “Opening the Scaling Tool GUI” on page 16-4
- “Specifying the Frequency Axis Limits in the Scaling Tool GUI” on page 16-5
- “Specifying the Frequency Band for Maximum Accuracy in the Scaling Tool GUI” on page 16-6
- “Saving the Scaling in the Scaling Tool GUI” on page 16-6

For an example of using the Scaling Tool GUI on a real model, see [Scaling Models to Maximize Accuracy](#).

For more information about scaling models from the command line, see the `prescale` reference page.

Opening the Scaling Tool GUI

To open the Scaling Tool GUI for a state-space model named `sys`, type `prescale(sys)`

The Scaling Tool GUI resembles one shown in the following figure.

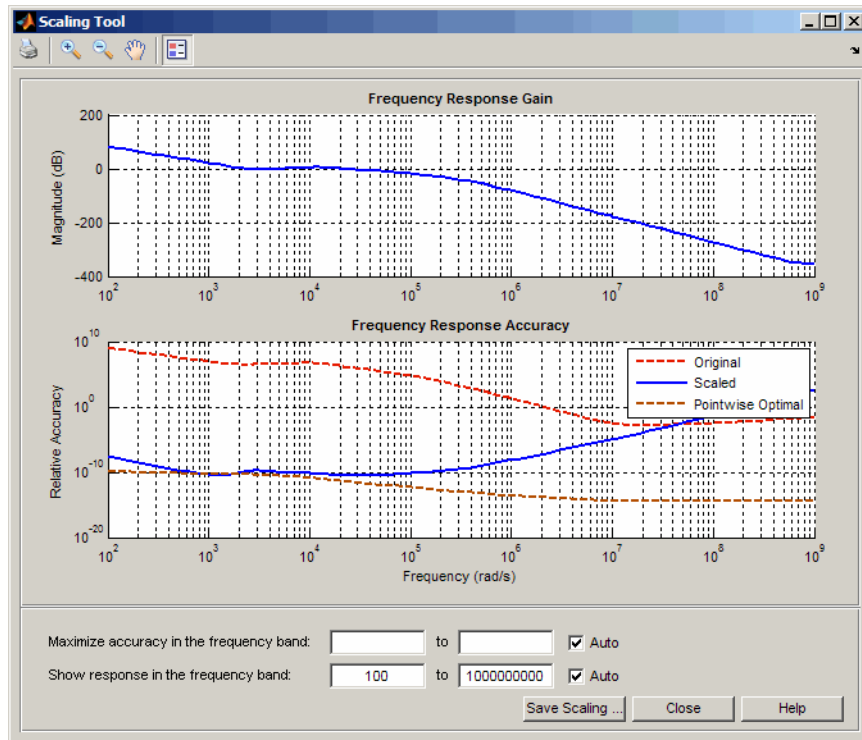

The Scaling Tool GUI contains the following plots:

- The **Frequency Response Gain** plot helps you determine the frequency band over which you want to maximize scaling.

For SISO systems, this plot shows the gain of your model. For MIMO systems, the plot shows the principle gain (largest singular value) of your model.

- The **Frequency Response Accuracy** plot allows you to view the accuracy tradeoffs for your model when maximizing accuracy in a particular frequency bands.

This plot shows the following information:

- Relative accuracy of the response of the original unscaled model in red
- Relative accuracy of the response of the scaled model in blue
- Best achievable accuracy when using independent scaling at each frequency in brown

When you compute some model characteristics, such as the frequency response or the system zeros, the software produces the exact answer for some perturbation of the model you specified. The *relative accuracy* is a measure of the worst-case relative gap between the frequency response of the original and perturbed models. The perturbation accounts for rounding errors during calculation. Any relative accuracy value greater than 1 implies poor accuracy.

Tip If the blue Scaled curve is close to the brown Pointwise Optimal curve in a particular frequency band, you already have the best possible accuracy in that frequency band.

Specifying the Frequency Axis Limits in the Scaling Tool GUI

You can change the limits of the plot axis to view a particular frequency band of interest in the Scaling Tool GUI. To view a particular frequency band, specify the band in the **Show response in the frequency band** fields.

This action updates the frequency axis of the Scaling tool to show the specified frequency band.

Tip To return to the default display, select the **Auto** check box.

Specifying the Frequency Band for Maximum Accuracy in the Scaling Tool GUI

To adjust the frequency band where you want maximum accuracy, set a new frequency band in the **Maximize accuracy in the frequency band** fields. You can visualize accuracy tradeoffs by trying out different frequency bands and viewing the resulting relative accuracy across the frequency band of interest.

Note You can use the **Frequency Response Gain** plot, which plots the gain of your model, to view the dynamics in your model to help determine the frequency band to maximize accuracy.

Each time you specify a new frequency band, the **Frequency Response Accuracy** plot updates with the result of the new scaling. Compare the Scaled curve (blue) to the Pointwise Optimal curve (brown) to determine where the new scaling is nearly optimal and where you need more accuracy.

Tip To return to the default scaling, select the **Auto** check box.

Saving the Scaling in the Scaling Tool GUI

When you find a good scaling for your model, save the scaled model as follows:

- 1 Click **Save Scaling**.

This action opens the **Save to Workspace** dialog box.

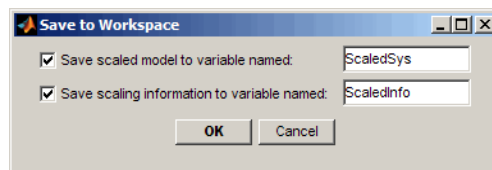

- 2 In the **Save to Workspace** dialog box, verify that any of the following items you want to save are selected, and specify variable names for these items.

- Scaled model
- Scaling information, including:
 - Scaling factors
 - Frequencies used to test accuracy
 - Relative accuracy at each test frequencyFor details about the scaling information, see the `prescale` reference page.

3 Click **OK**.

This action sets the State-Space (@ss) object `Scaled` property of your model to true. When you set this property to True, the Control System Toolbox algorithms skip the automated scaling of the model.

Using the SISO Design Tool and the LTI Viewer

- Chapter 17, “SISO Design Tool”
- Chapter 18, “LTI Viewer”

SISO Design Tool

- “SISO Design Tool Overview” on page 17-2
- “Opening the SISO Design Tool” on page 17-4
- “Using the SISO Design Task Node” on page 17-5
- “Using the SISO Design Task in the Controls & Estimation Tools Manager” on page 17-12
- “SISO Design Task Graphical Tuning Window” on page 17-43
- “Using the Graphical Tuning Window Menu Bar” on page 17-45
- “Using the Graphical Tuning Window Toolbar” on page 17-57
- “Using the Right-Click Menus in the Graphical Tuning Window” on page 17-58
- “LTI Viewer for SISO Design Task Design Requirements” on page 17-80

SISO Design Tool Overview

The SISO Design Tool is a graphical-user interface (GUI) to design compensators.

The SISO Design Tool has the following components:

- The SISO Design Task Node in the Control and Estimation Tools Manager, a user interface (UI) that facilitates the design of compensators for single-input, single-output feedback loops through a series of interactive panes.
- The Graphical Tuning Window, a graphical user interface (GUI) for displaying and manipulating the Bode, root locus, and Nichols plots for the controller currently being designed. This window is titled SISO Design for *Design Name*. The Graphical Tuning Window by default displays the root locus and Bode diagrams for your imported systems. The two are dynamically linked; for example, if you change the gain in the root locus, it immediately affects the Bode diagrams as well.
- The SISO Design Task-associated LTI Viewer.
- A tool that automatically generates compensators using PID, internal model control (IMC), or linear-quadratic-Gaussian (LQG) methods.
- Optimization-based tuning methods that automatically tune the system to satisfy design requirements (available if you have Simulink Design Optimization software installed).

For more information about SISO Design Tool menus and options, see:

- “Opening the SISO Design Tool” on page 17-4
- “Using the SISO Design Task Node” on page 17-5
- “Using the SISO Design Task in the Controls & Estimation Tools Manager” on page 17-12
- “SISO Design Task Graphical Tuning Window” on page 17-43
- “Using the Graphical Tuning Window Menu Bar” on page 17-45
- “Using the Graphical Tuning Window Toolbar” on page 17-57

- “Using the Right-Click Menus in the Graphical Tuning Window” on page 17-58
- “LTI Viewer for SISO Design Task Design Requirements” on page 17-80

Opening the SISO Design Tool

To open the SISO Design Task node in the Control and Estimation Tools Manager and the Graphical Tuning Window, type

```
sisotool
```

Load the Gservo model that you want to control in the MATLAB workspace by typing

```
load ltiexamples
```

In the **Architecture** tab of the Control and Estimation Tools Manager GUI, click **System Data** to import the model into the SISO Design Tool.

Tip You can import LTI models and arrays of LTI models for the plant **G** and sensor **H** into the SISO Design Tool. For more information, see “Importing Models into the SISO Design Tool” in the *Getting Started Guide*.

Alternatively, to open the SISO Design Tool with the Gservo system, type

```
sisotool(Gservo)
```

Using the SISO Design Task Node

In this section...

“The SISO Design Task Node” on page 17-5

“SISO Design Task Node Menu Bar” on page 17-5

The SISO Design Task Node

The following figure shows the SISO Design Task node in the Control and Estimation Tools Manager.

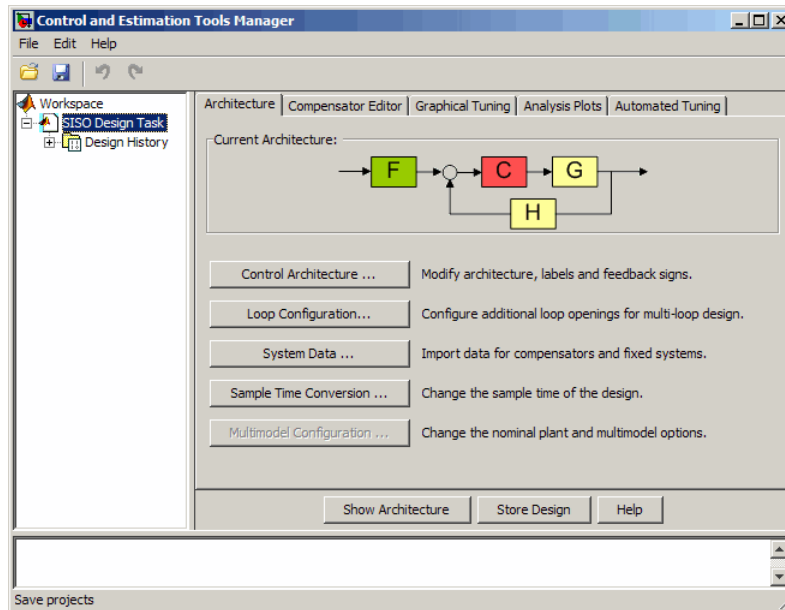

SISO Design Task Node on the Control and Estimation Tools Manager

SISO Design Task Node Menu Bar

The SISO Design Task node menu bar contains the following menus:

File Edit Help

File Menu Options

Load
Save
Export
Close

- **Load**

To load a saved SISO Design Tool project, select **Load** from the **File** menu. This opens the Load Projects window.

Projects are saved as MAT-files. Select the project you want to load from the list, or click ... to browse for projects you can select from, and click **OK**.

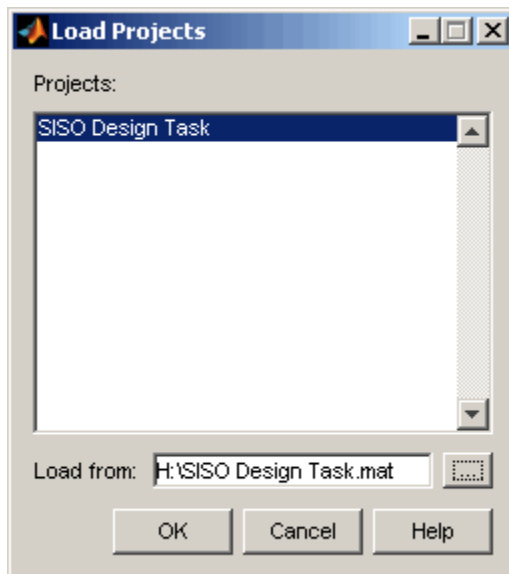

- **Save**

You can exit the MATLAB technical computing environment and later restore the SISO Design Tool to the state you left it in by saving the project. Select **Save** from the **File** menu. This opens the **Save Projects** window.

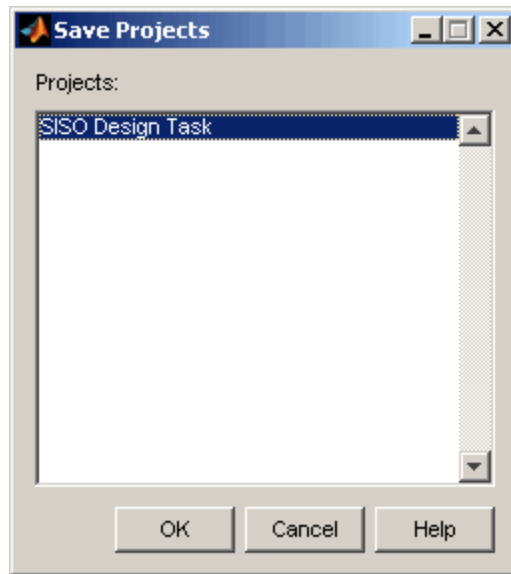

To save a project, specify a file name and click **OK**. The current state and configuration of your SISO Design Tool are saved as a MAT-file. To load a saved project, select **Load** from the **File** menu (see previous bullet).

- **Export**

Selecting **Export** from the **File** menu opens the SISO Tool Export window.

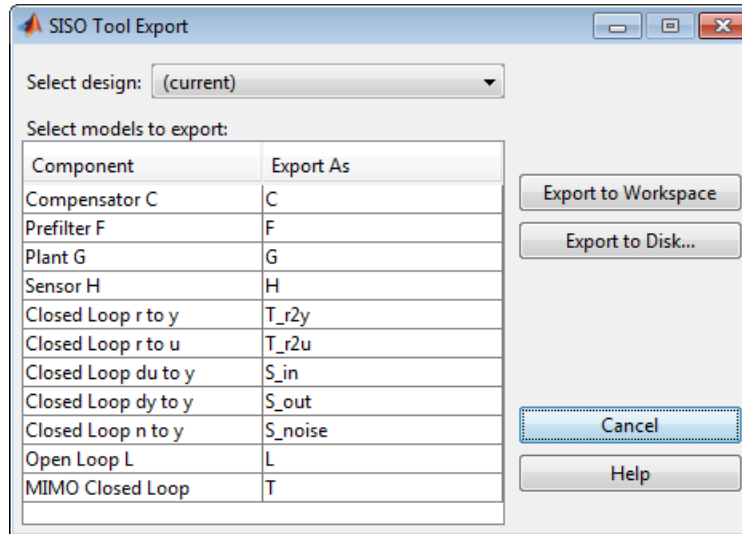

You can perform the following tasks in this window:

- Export models to the MATLAB workspace or to a disk. The exported models are:
 - LTI objects if the plant and sensor are LTI models
 - Arrays of LTI objects if the plant or sensor are arrays of LTI models
- Rename models when exporting
- Save variations on models, including open and closed loop models, sensitivity transfer functions, and state-space representations

To export models to the MATLAB workspace, follow these steps:

- 1** Select the model you want to export from the Component list by left-clicking the model name. To select more than one model, hold down the **Shift** key if they are adjacent on the list. If you want to save nonadjacent models, hold down the **Ctrl** key while selecting the models.
- 2** For each model you want to save, specify a name in the model's cell in the Export As list. A default name exists if you do not want to assign a new name.
- 3** Click **Export to Workspace**.

If you want to save your models as a MAT-file, follow steps 1 and 2 and click **Export to Disk**, which opens this window.

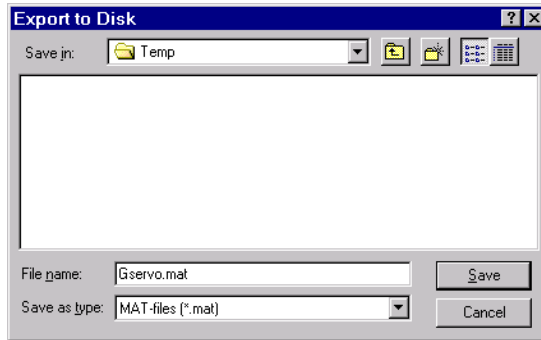

Choose where you want to save the file in the **Save in** field and specify the name of the MAT-file in the **File name** field. Click **Save** to save the file.

- **Close**

Use **Close** to close the SISO Design Tool. This closes all components of the SISO Design Tool.

Edit Menu Options

Undo
Redo
SISO Tool Preferences

- **Undo**

Use **Undo** to go back in design steps. Note that the **Undo** menu changes when the task you have just performed changes. For example, if you change the compensator gain, the **Undo** menu item now reads **Undo Edit Gain**.

- **Redo**

Use **Redo** to go forward in the design steps. You can only use **Redo** if you have previously used **Undo**. Like the **Undo** menu, the **Redo** menu changes when the task you have just performed changes. For example, if you change the compensator gain, and then select **Undo Edit Gain**, the Redo menu item becomes **Redo Edit Gain**.

- **SISO Tool Preferences**

Select **SISO Tool Preferences** from the **Edit** menu to open the **SISO Tool Preferences** dialog box.

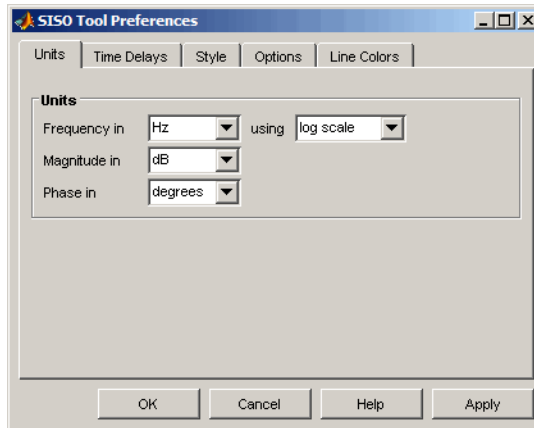

You can use this window to do the following:

- Change units
- Add plot grids, change font styles for titles, labels, etc., and change axes foreground colors
- Change the compensator format
- Show or hide system poles and zeros in Bode diagrams

For a discussion of this window's features, see "Setting Toolbox Preferences" online in the Control System Toolbox documentation.

Help

Selecting **About the Control and Estimation Tools Manager** in the **Help** menu opens a window with the version number and a copyright notice for this product.

Buttons Available from Any Pane

- "Showing the Control Architecture" on page 17-11

- “Store Design” on page 17-11

Showing the Control Architecture. Click **Show Architecture** to open a window that displays the block diagram for your model. For example,

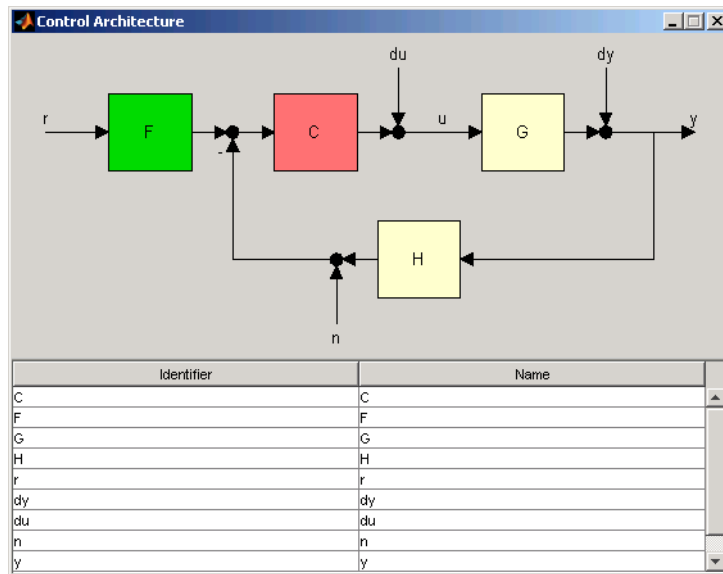

Below the block diagram is a table that shows the default names for each part of the block diagram and the assigned name, if you have one.

Store Design. Click **Store Design** to save your design to your SISO Design Task node. Click on **Design** under the node to see a snapshot summary of your design. Click on the **Design History** node to show a list of all stored designs.

Using the SISO Design Task in the Controls & Estimation Tools Manager

In this section...
“Architecture” on page 17-12
“Compensator Editor” on page 17-19
“Graphical Tuning” on page 17-20
“Analysis Plots” on page 17-24
“Automated Tuning” on page 17-25

Architecture

Use the **Architecture** tab for:

- “Block Diagram Structure Modifications” on page 17-13
- “Loop Configuration” on page 17-15
- “Model Import” on page 17-15
- “Sample Times for Continuous/Discrete Conversions” on page 17-17
- “Multimodel Configuration” on page 17-18

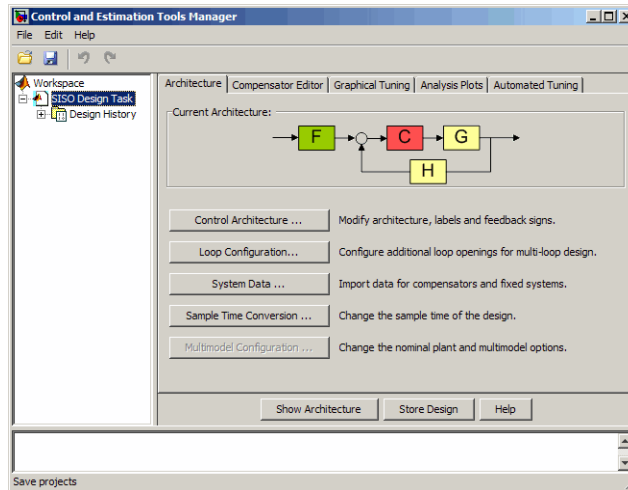

Architecture Pane on the SISO Design Task Node

Block Diagram Structure Modifications

Click **Control Architecture** to change the feedback structure and label signals and blocks. The following pane appears:

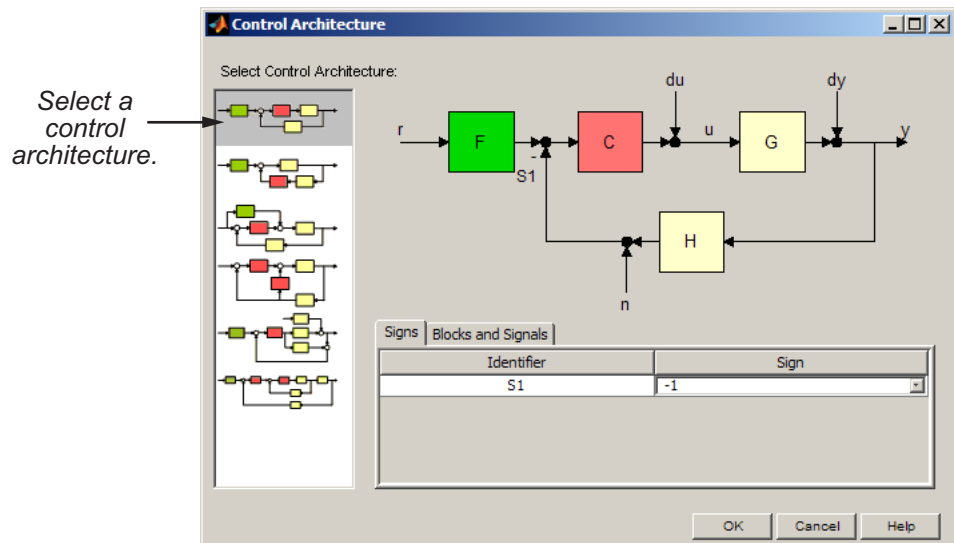

Select an architecture from the list of block configurations. These include compensator in the forward path, compensator in the feedback path, feedforward controller, and various multi-loop configurations. The window automatically updates to show the selected configuration.

Each configuration has associated Signs and Blocks and Signals panes. This figure shows the Signs pane.

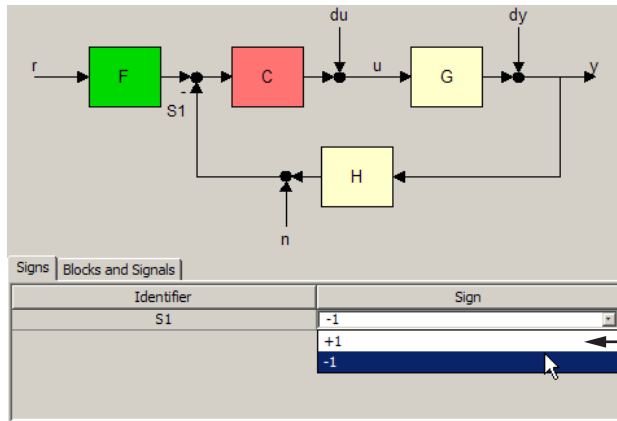

Use menu to toggle between + and - for feedback signals at summing junction.

The Blocks and Signals pane displays the generic identifier, for example F for the prefilter block, and a default name.

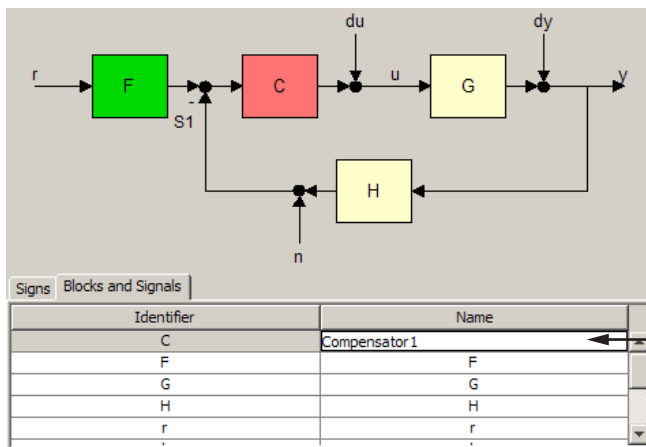

Double-click to change name.

On the Signs pane, use the menu to toggle between.

Loop Configuration

Click **Loop Configuration** to configure loops for multi-loop design by opening signals to remove the effects of other feedback loops.

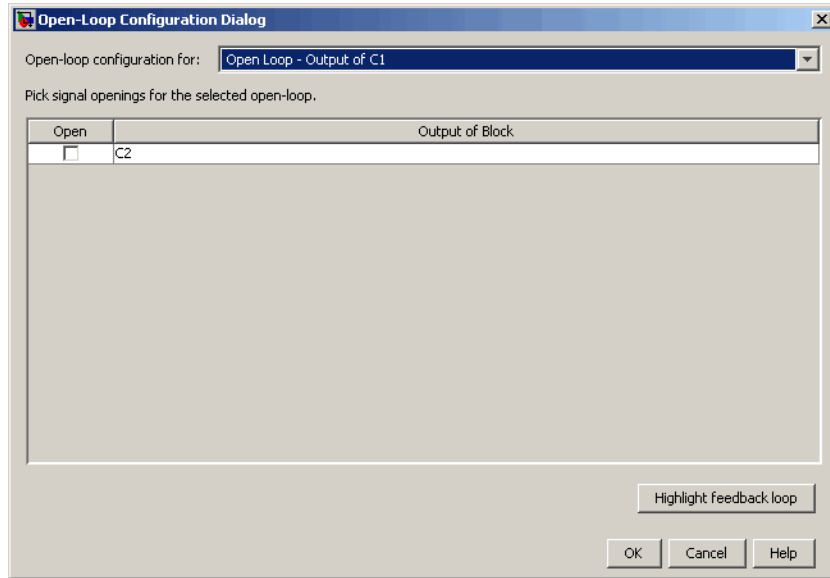

To specify openings for a given open loop, select the loop in the combo box. Click **Highlight Feedback Loop** to see the effects of the selected openings.

For an example of how to use this window in design, see Multi-Loop Compensator Design.

Model Import

Click **System Data** on the Architecture pane to import models into your system. This opens the System Data dialog box, shown below.

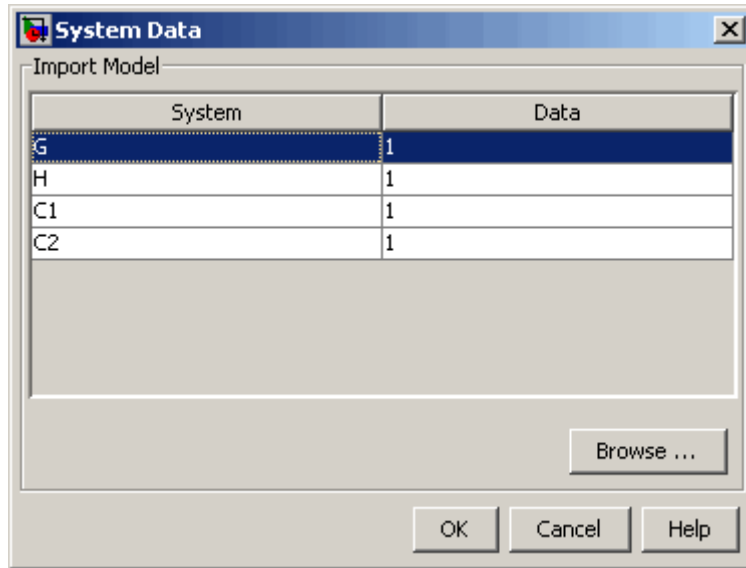

You can import models for the plant (**G**), compensator (**C**), prefilter (**F**), and/or sensor (**H**). **G** or **H** or both are LTI models or row or column arrays of LTI models. If both **G** and **H** are arrays, their sizes must match.

To import a model:

- 1 Select a system in the **System** column and click **Browse**. The Model Import dialog box opens, as shown in the next figure.

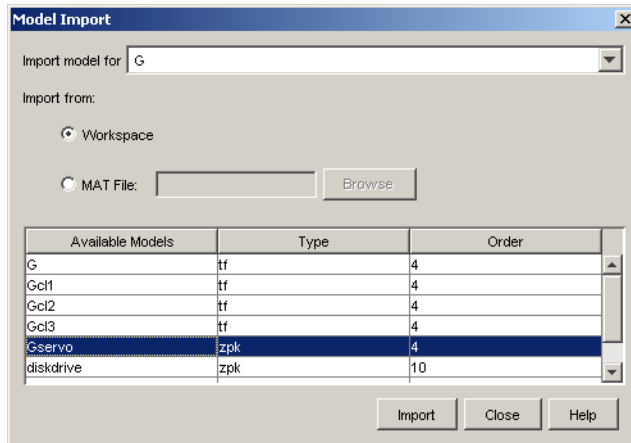

2 Select a model from the **Available Models** list. You can import models from:

- The MATLAB workspace
- A MAT-file

3 Click **Import**, then click **Close**. You can now see the model loaded into the system selected in the **System Data** dialog.

4 Click **OK**. The Graphical Tuning window is updated with the model you loaded.

Alternatively, you can import by entering a valid expression or variable (double, LTI object or row or column array of LTI objects) in the Data column in the System Data window.

For more information, see “Importing Models into the SISO Design Tool”.

Sample Times for Continuous/Discrete Conversions

Click **Sample Time Conversion** to convert the sample time of the system or switch between different sample times to design different compensators.

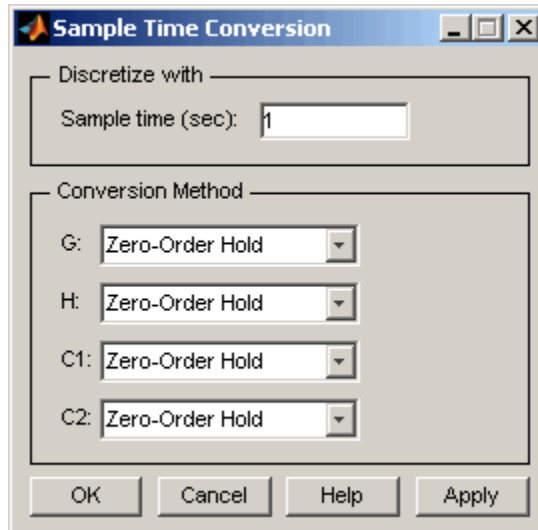

Choose from Zero-Order Hold, First-Order Hold, Impulse Variant, Tustin, Tustin w/Prewarping, and Matched Pole-Zero.

For a full description, see “Continuous/Discrete Conversions Using the Sample Time Conversion Dialog Box” on page 17-51.

Multimodel Configuration

The **Multimodel Configuration** button is enabled only when you import or open the SISO Design Tool GUI with a row or column arrays of LTI models for the plant **G** or sensor **H** or both. The LTI arrays model system variations in the plant and sensor. If both **G** and **H** are arrays, their sizes must match.

Click **Multimodel Configuration** to specify the nominal model and frequency grid for multimodel computations. This action opens the Multimodel Configuration Dialog window, as shown in the next figure.

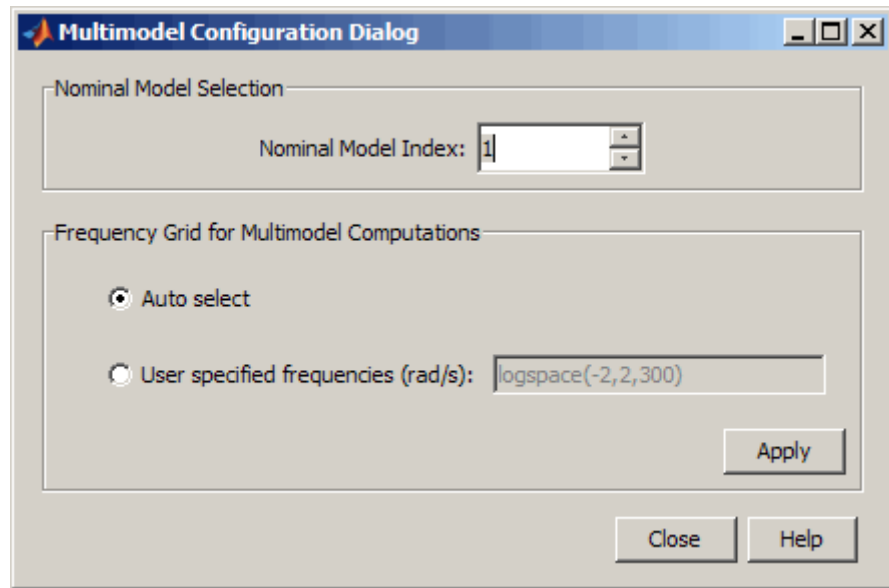

For more information, see “Control Design Analysis of Multiple Models”.

Compensator Editor

Use the **Compensator Editor** for adding or editing gains, poles, and zeros.

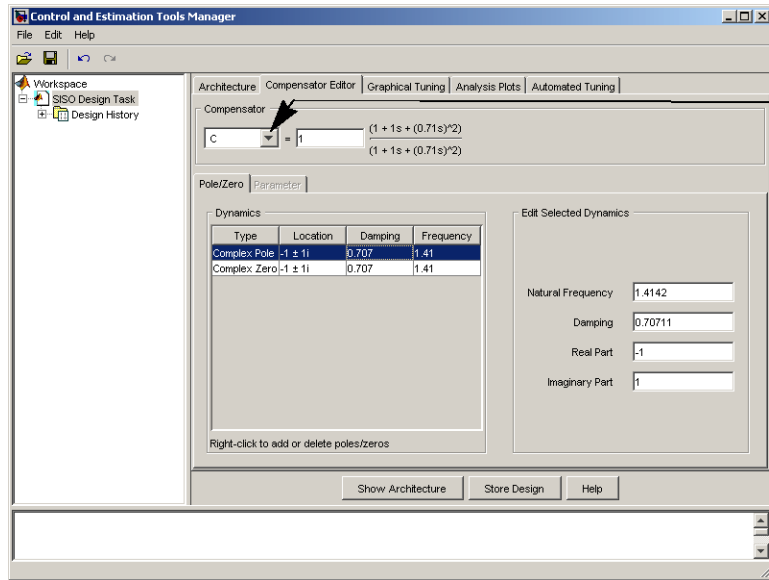

Compensator Editor Pane on the SISO Design Task Node

- 1 Enter the compensator gain in the text box in the top part of the pane.
- 2 Add or remove compensator poles and zeros by right-clicking in the **Dynamics** table.
- 3 Adjust pole and zero settings by entering values directly in the **Edit Selected Dynamics** group box.

Graphical Tuning

Use the Graphical Tuning pane for

- “Configuring Design Plots for the Graphical Tuning Window” on page 17-21
- “Selecting New Loops to Tune” on page 17-23
- “Refocusing on the Graphical Tuning Window” on page 17-23

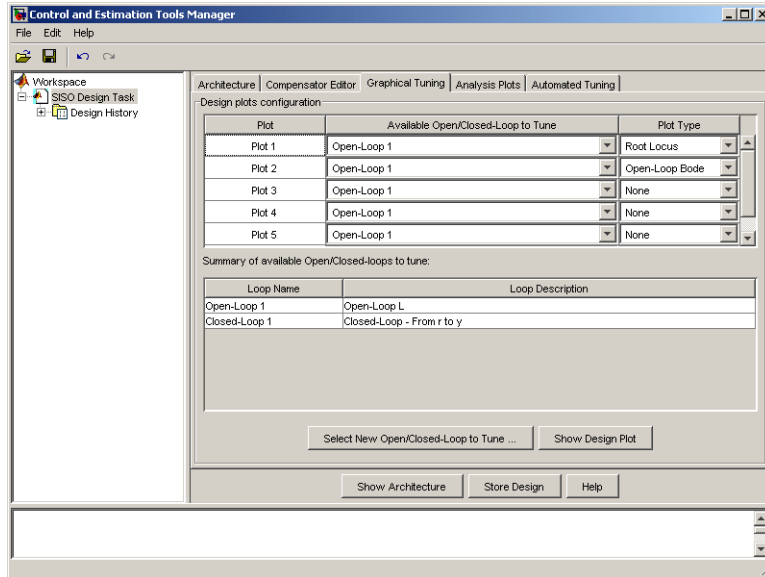

Graphical Tuning Pane on the SISO Design Task Node

Configuring Design Plots for the Graphical Tuning Window

Click the **Graphical Tuning** tab to configure design plots displayed in the Graphical Tuning Window.

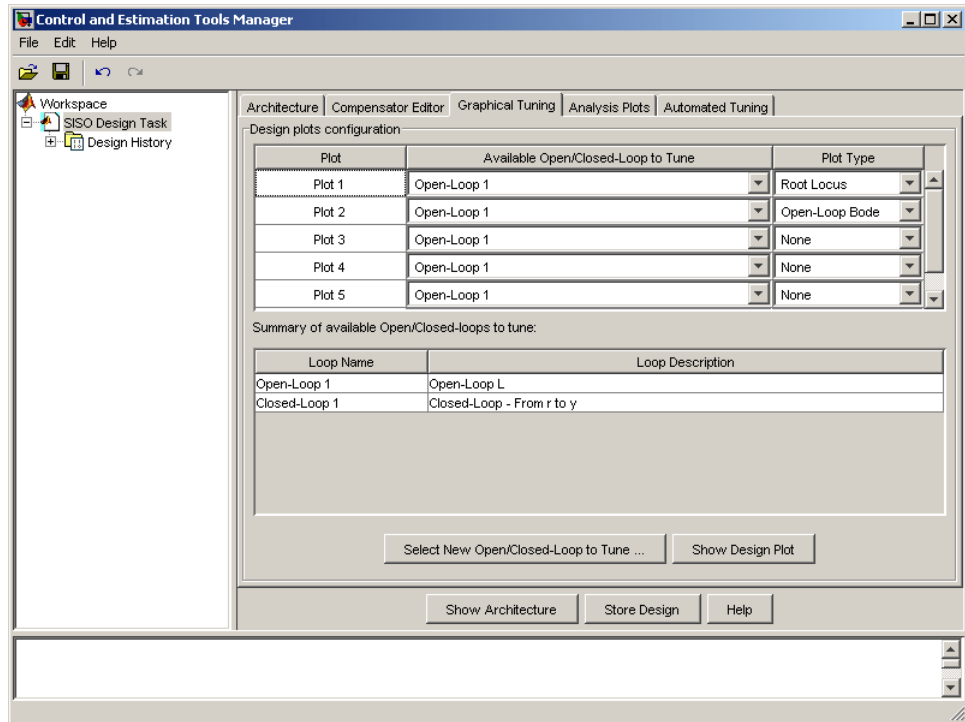

In the Graphical Tuning window, use design plots to graphically manipulate system response. These design plots are dynamically linked to the SISO Design Task. When you change the dynamics of your compensator in either the SISO Design Task or the Graphical Tuning window, the design updates in both places.

For open-loop responses, the available plot types are:

- Root locus
- Nichols
- Bode

For closed-loop responses, the available plot type is Bode.

For row or column arrays of LTI models, the design plots show the individual response of all models in the array by default. For more information, see “Using the Graphical Tuning Window” in the Getting Started Guide.

Selecting New Loops to Tune

Click **Select New Open/Closed Loops to Tune** to open a window for specifying new loops to tune.

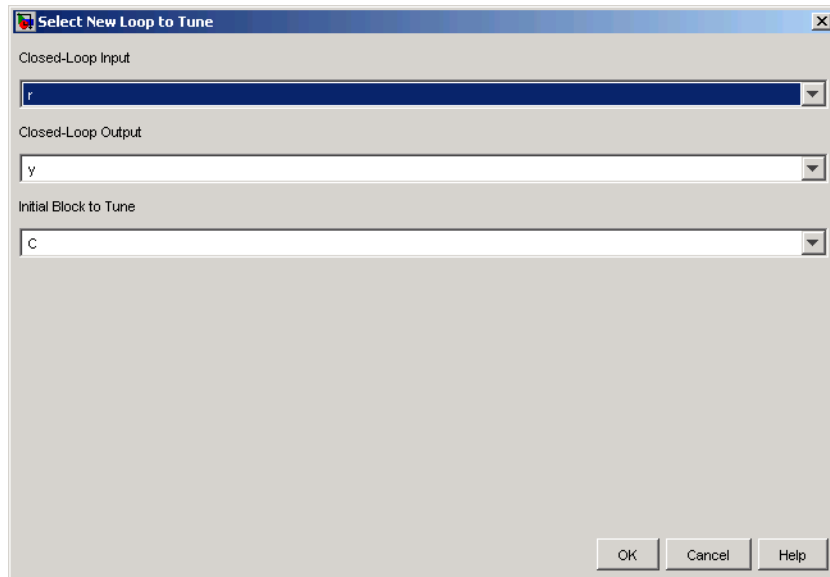

Use the pull down menus to select the desired closed loop to tune by specifying the input, output, and blocks for tuning. Using the dialog box, you can select additional closed loops to tune.

Any loop you specify is displayed in the **Summary of Available Loops to Tune** in the Graphical Tuning pane. The list is also available in the **Design plots configuration** table of the same pane. You can use the latter for configuring design plots.

Refocusing on the Graphical Tuning Window

Click **Show Design Plot** to change the focus to the Graphical Tuning window.

Analysis Plots

Use the **Analysis Plots** pane for

- “Customizing Loop Responses” on page 17-24
- “Adding New Response Plots” on page 17-25
- “Opening or Changing the Focus to the LTI Viewer” on page 17-25

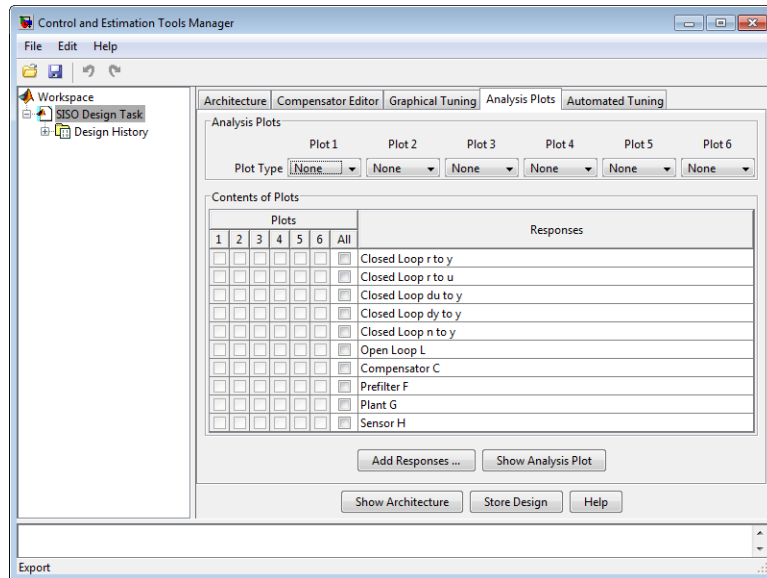

Analysis Plots Pane on the SISO Design Task Node

Customizing Loop Responses

The following sections describe the main components of the **Analysis Plots** pane.

Analysis Plots. You can have up to six plots in one LTI Viewer. To add a plot, start by selecting "Plot 1" from the list of plots. Then select a new plot type from the pull down menu. You can choose any of the plots available in the LTI Viewer. Select "None" to remove a plot.

Contents of plots. Once you have selected a plot type, you can include several open- and closed-loop transfer function responses for display. You can plot open-loop responses for each of the components of your system, including your compensator (**C**), plant (**G**), prefilter (**F**), or sensor (**H**). In addition, various closed loop and sensitivity response plots are available.

For row or column arrays of LTI models, the analysis plots show the response of the nominal model only by default. For more information, see “Analysis Plots for Loop Responses” in the Getting Started Guide.

Adding New Response Plots

Click **Add Responses** to open a window with three drop-down menus for selecting open and closed loop responses for various input and output nodes in the control architecture block diagram. This allows you to select additional responses for viewing. The **Response** table updates automatically to include the selected response.

Opening or Changing the Focus to the LTI Viewer

Click **Show Analysis Plot** to open a new LTI Viewer for SISO Design with the response plots that you selected. All the plots open in one instance of the LTI Viewer.

Automated Tuning

Use the **Automated Tuning** pane to select a method for automatic tuning of your compensator design. Automated tuning methods help you design an initial compensator for a SISO loop that satisfies your design specifications.

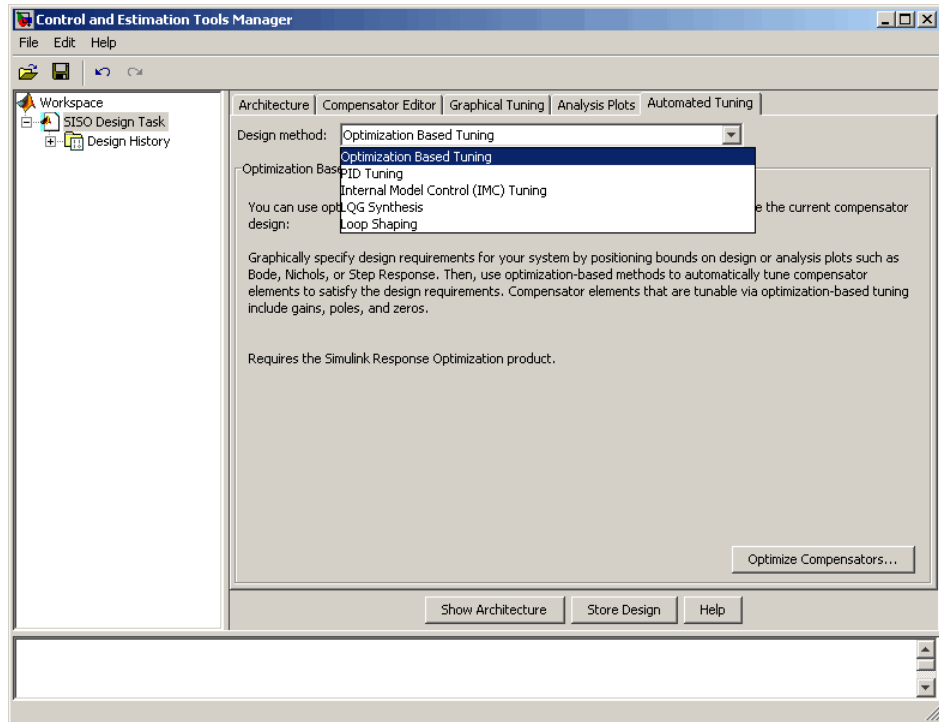

You can choose among the following design methods:

- “Optimization-Based Tuning” on page 17-28 — Optimize compensator parameters using design requirements implemented in graphical tuning and analysis plots
- “PID Tuning” on page 17-29 — Tune PID controller parameters using the Robust response time tuning algorithm or classic tuning formulas
- “Internal Model Control (IMC) Tuning” on page 17-37 — Obtain a full-order stabilizing feedback controller using the IMC design method
- “LQG Synthesis” on page 17-38 — Design a full-order stabilizing feedback controller as a Linear-Quadratic-Gaussian (LQG) tracker
- “Loop Shaping” on page 17-40 — Find a full-order stabilizing feedback controller with a desired open loop bandwidth or shape

After you select a design method, the pane updates to display the corresponding options.

Note If the particular design method you are using does not apply or fails, try selecting different tuning specifications or switch to a different design method.

Stability of an Effective Plant for Automated Tuning

Knowing the stability of the effective plant in your model may help you understand which automated tuning methods work for your model. Some of the automated tuning methods only apply to compensators whose open loops

($L = C\hat{P}$) have stable effective plants (\hat{P}).

An *effective plant* is the system controlled by the compensator you design and contains all elements of the open loop in your model other than this compensator. The following figure shows two examples of effective plants.

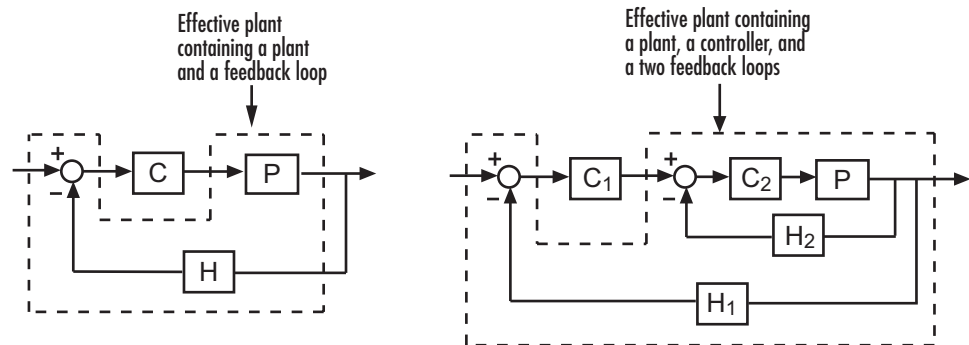

Generic Work Flow

For each method, follow these steps to do your design:

- 1** Select an automated tuning algorithm from the **Design method** drop-down menu.
- 2** If you select Optimization-Based Tuning, stop here and see “Optimization-Based Tuning” on page 17-28.

- 3** Select a compensator from the drop-down menu.
- 4** Determine how you want the compensator to perform and set the tuning specifications.
- 5** Click **Update Compensator** and notice the changes in the associated design and analysis plots.

Note If you encounter a disabled **Update Compensator** button, try selecting different tuning specifications (Step 4) or switch to a different tuning algorithm (Step 1). The disabled button means that the current method does not work for your model.

Optimization-Based Tuning

Optimization-based tuning is available only if you have Simulink Design Optimization software installed. You can use this method to either:

- Directly tune response signals within Simulink models.
- Tune responses of LTI systems using a SISO Design Task.

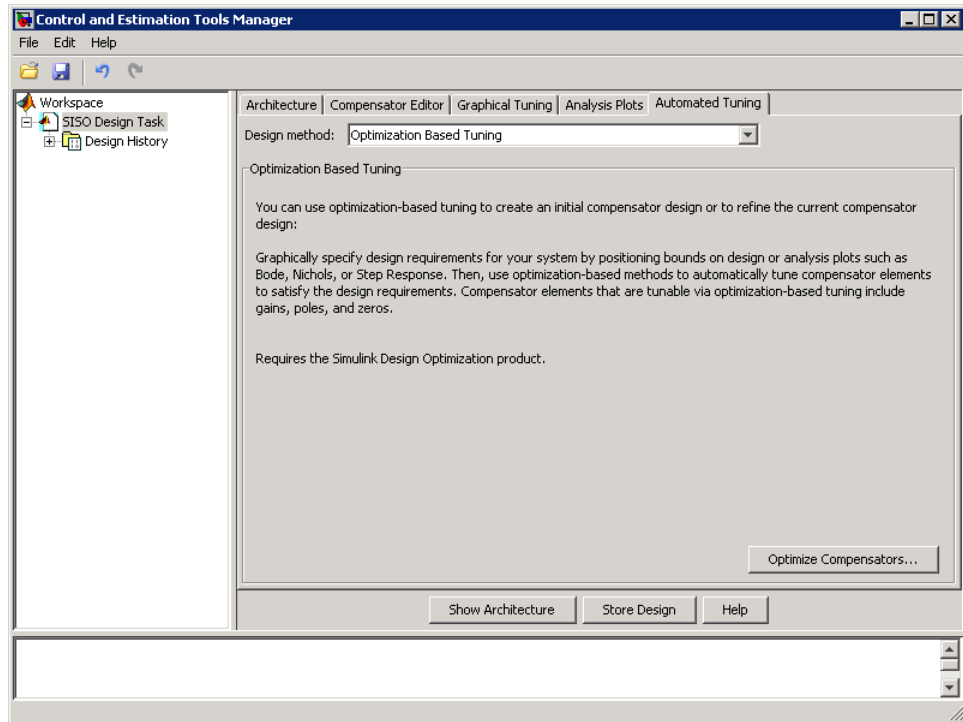

See “Frequency Domain Response Optimization Example” in the Simulink Design Optimization documentation for more details.

PID Tuning

PID (proportional-integral-derivative) control is the most popular control technique used in modern industry.

To use automatic PID tuning, select PID Tuning from the Automated Tuning pane of the Control and Estimation Tools Manager. In most cases, the PID controllers resulting from PID tuning provide acceptable performance. Use the “Analysis Plots” on page 17-24 to verify design results.

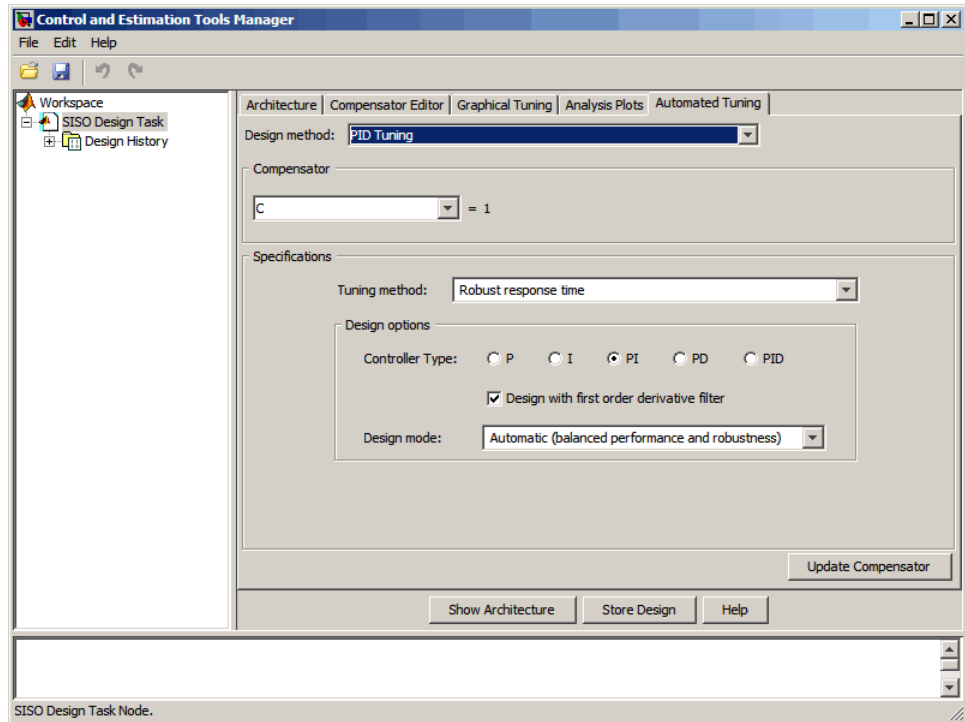

Types of PID Controllers.

SISO Design Tool provides automated tuning for the following PID controller types.

- P — Proportional-only control
- I — Integral-only control (available only for the Robust response time tuning method)
- PI — Proportional-integral control
- PD — Proportional-derivative control (available only for the Robust response time tuning method)
- PDF — Proportional-derivative control with a low-pass filter on the derivative term (available only for the Robust response time tuning method)
- PID — Proportional-integral-derivative control

- PIDF — Proportional-integral-derivative control with a low-pass filter on the derivative term

PID Tuning Methods.

SISO Design Tool provides a Robust response time algorithm for interactive tuning, as well as six well-known classical tuning methods.

Robust response time. This method computes PID parameters to robustly stabilize your system based on the bandwidth and phase margin that you specify. Using the robust response time method you can:

- Tune interactively, adjusting bandwidth and phase margin to achieve your desired balance between performance and robustness
- Tune any type of PID controller (P, I, PI, PD, PDF, PID, or PIDF)
- Tune all PID parameters, including the derivative filter
- Design for plants that are stable, unstable, or integrating

Classical design formulas. SISO Design Tool includes the following well-known PID design formulas:

- Approximate MIGO frequency response — Closed-loop frequency-domain approximate M-constrained integral gain approximation (see [1], Section 7.5).
- Approximate MIGO step response — Open-loop time-domain approximate M-constrained integral gain approximation (see [1], Sections 7.3–7.4).
- Chien-Hrones-Reswick — Approximates the plant as a first-order model with a time delay and computes PID parameters using a Chien-Hrones-Reswick look-up table for zero overshoot and disturbance rejection (see [1], Section 6.2).
- Skogestad IMC — Approximates the plant as a first-order model with a time delay and computes PID parameters using Skogestad design rules (see [2]).

(This method is different from selecting “Internal Model Control (IMC) Tuning” on page 17-37 as the full-order compensator tuning method).

- Ziegler-Nichols frequency response — Computes controller parameters from a Ziegler-Nichols lookup table, based on the ultimate gain and frequency of the system (see [1], Section 6.2).
- Ziegler-Nichols step response — Approximates the plant as a first-order model with a time delay that and computes PID parameters using the Ziegler-Nichols design method (see [1], Section 6.2).

The classical design formulas:

- Require a stable or integrating plant.
- Can design for P, PI, PID, or PID with derivative filter.
- Cannot tune the derivative filter. If you select PID with derivative filter, classical design formulas set the filter time constant to $Td/10$, where Td is the tuned derivative time.

Automated Tuning using the Robust Response Time Method.

To use the robust response time tuning method:

- 1 Select Robust response time from the **Tuning method** menu.

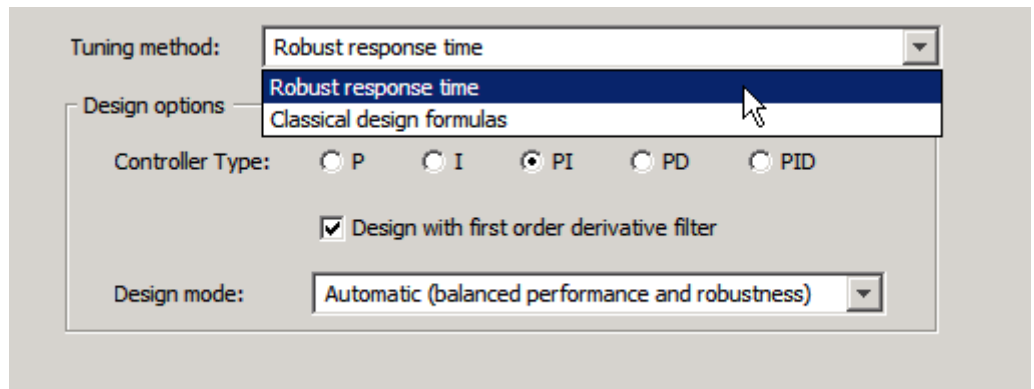

- 2 Choose a controller type by clicking the corresponding radio button. To include a first-order filter on the derivative action for PD or PID controller type, check the **Design with first order derivative filter** checkbox.

Note If you are tuning a PID Controller block in a Simulink model and your block is type P, I, or PI, select the same controller type as the block. If your block is type PD or PID, select the corresponding button and check the **Design with first order derivative filter** checkbox.

- 3** Click **Update Compensator** to design a controller of the selected type.

By default, the SISO Design Tool automatically computes controller parameters for balanced performance and robustness.

- 4** Analyze the response using the analysis plots you select on the Analysis Plots pane.
- 5** To design a controller interactively, select **Interactive** (adjustable performance and robustness) from the **Design mode** menu. This selection activates the **Bandwidth** and **Phase Margin** sliders.

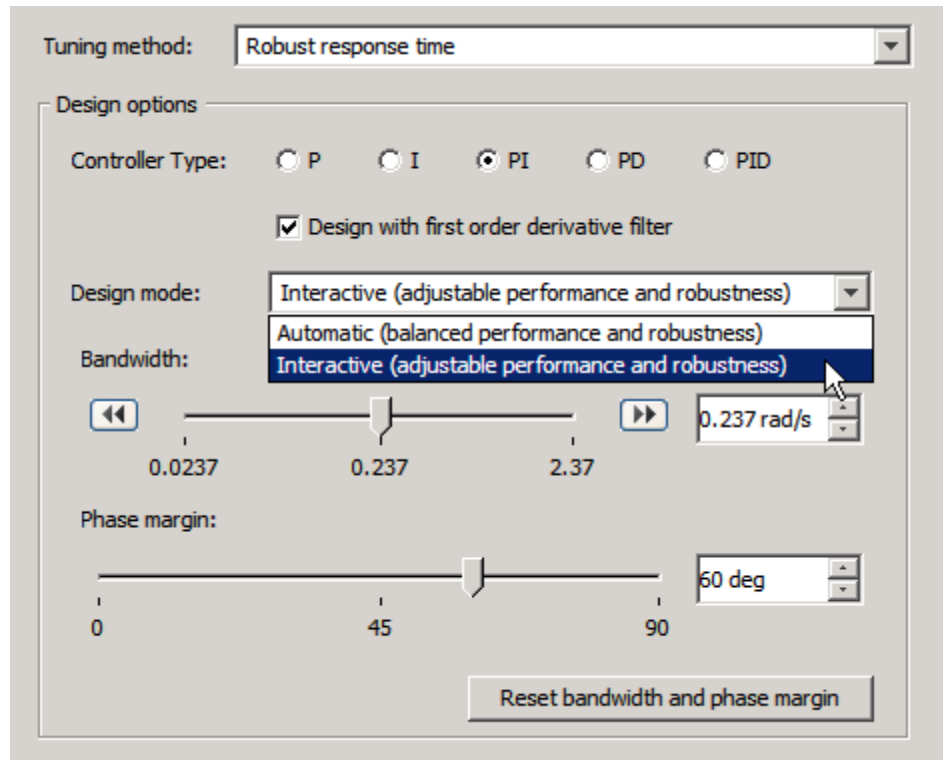

Adjust the bandwidth and phase margin to achieve your desired controller performance. For example:

- Increase the bandwidth for a more aggressive controller.
- Increase the phase margin to reduce overshoot.

You can adjust the bandwidth and phase margin values by:

- Moving the sliders
- Entering values in the text field
- Incrementally adjusting the values in the text field using the up and down arrows.

To increase or decrease the bandwidth by a factor of 10, click the right or left double arrows, respectively.

Note Click the **Reset bandwidth and phase margin** button at any time to return the sliders to the bandwidth and phase margin of the default compensator design for your plant.

- 6 Click **Update Compensator** again. SISO Design Tool computes new controller parameters for the specified target bandwidth and phase margin. Repeat steps 4-6 as necessary to achieve your desired performance.

Note SISO Design Tool displays the tuned compensator in zpk form in the **Compensator** section of the Automated Tuning Pane. To convert the compensator to parallel or standard PID form, export the compensator to the MATLAB workspace, as described in “SISO Design Task Node Menu Bar” on page 17-5. Then use the `pid` or `pidstd` commands to convert the exported compensator to parallel or standard PID parameters, respectively.

Automated Tuning using Classical Design Formulas.

To use one of the classical design formulas:

- 1 Select Classical design formulas from the **Tuning method** menu.

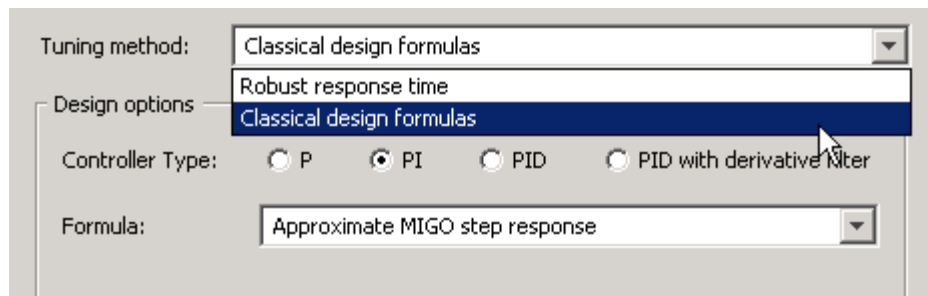

- 2 Select a controller type (P, PI, PID, or PID with derivative filter) by clicking the corresponding radio button.

Note If you are tuning a PID Controller block in a Simulink model and your block is type P or PI, select the same controller type as the block. If your block is type PID, select **PID with derivative filter**. If your block is type PD or I, use the Robust response time tuning method.

- 3 Select the classical design formula you want to use from the **Formula** menu.

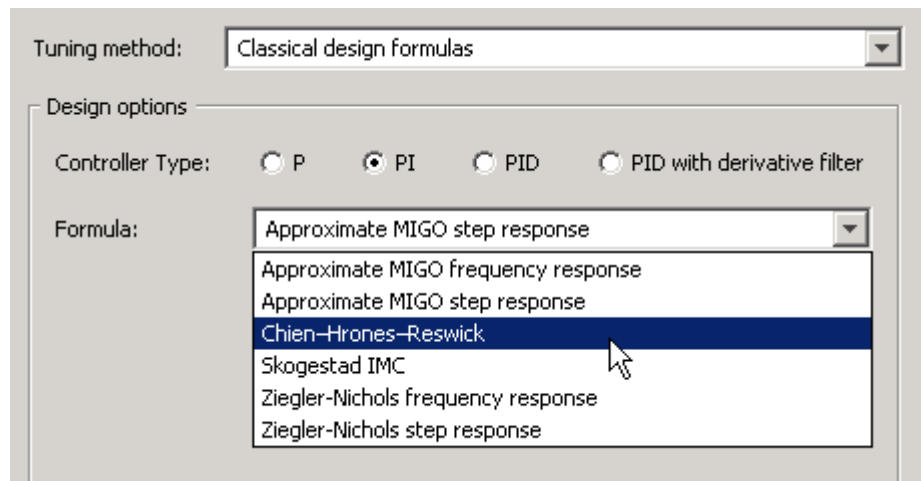

- 4 Click the **Update Compensator** button to design a controller using the selected formula.

Note SISO Design Tool displays the tuned compensator in zpk form in the **Compensator** section of the Automated Tuning Pane. To convert the compensator to parallel or standard PID form, export the compensator to the MATLAB workspace, as described in “SISO Design Task Node Menu Bar” on page 17-5. Then use the `pid` or `pidstd` commands to convert the exported compensator to parallel or standard PID parameters, respectively.

References.

- [1] Åström, K. J. and Hägglund, T. *Advanced PID Control*, Research Triangle Park, NC: Instrumentation, Systems, and Automation Society, 2006.
- [2] Skogestad, S., “Simple analytic rules for model reduction and PID controller tuning.” *Journal of Process Control*, Vol. 13, No. 4, 2003, pp. 291–309.

Internal Model Control (IMC) Tuning

IMC design generates a full-order feedback controller that guarantees closed-loop stability when there is no model error. It also contains an integrator, which guarantees zero steady-state offset for plants without a free differentiator. You can use this tuning method for both stable and unstable plants.

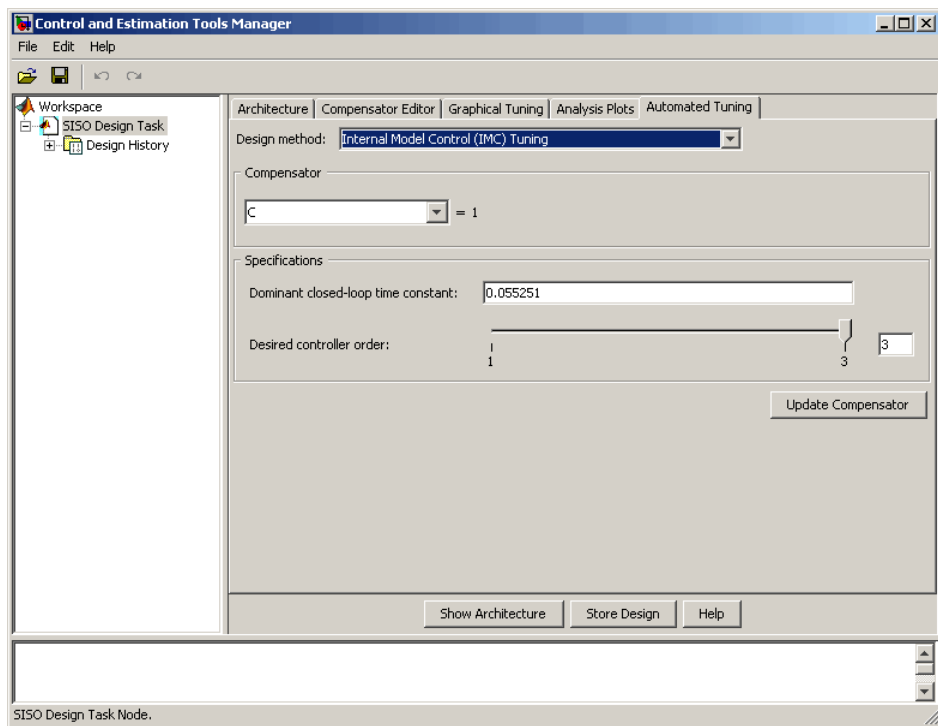

To design an IMC controller:

- 1** Specify a value in the **Dominant closed-loop time constant** field.
The initial value is set as 5% of the open-loop settling time. In general, increasing this value slows down the closed system and makes it more robust.
- 2** Specify a value in the **Desired controller order** field using the slider.
After you obtain a full-order feedback controller, you can try to reduce its order. You may lose performance and closed-loop stability if you reduce the order.
- 3** Click **Update Compensator**.

LQG Synthesis

LQG tracker design generates a full-order feedback controller that guarantees closed-loop stability. It also contains an integrator, which guarantees zero steady-state error for plants without a free differentiator.

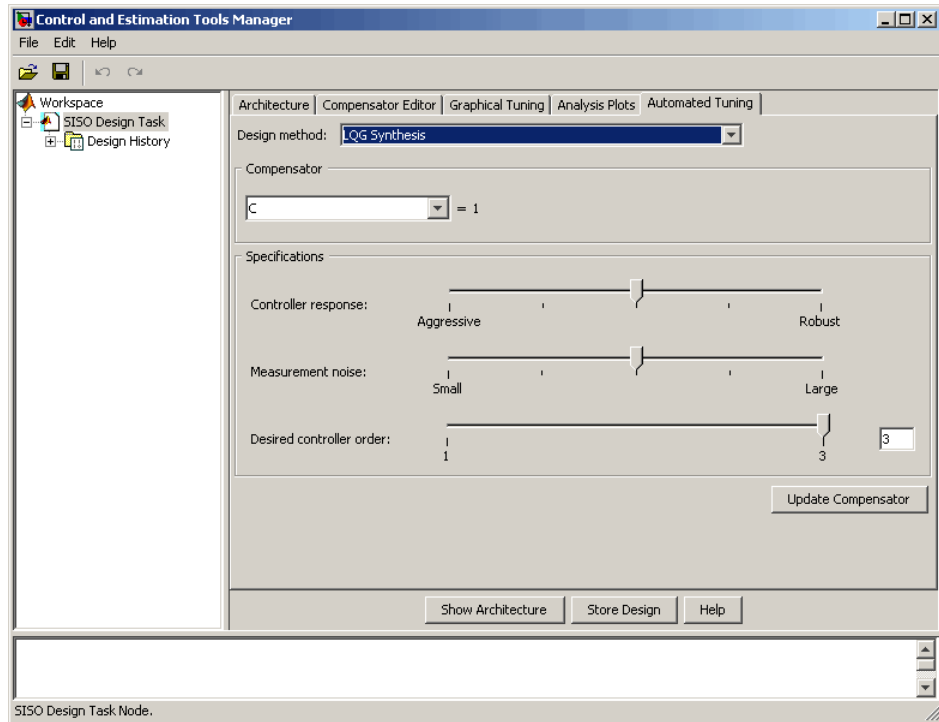

To design an LQG controller:

1 Specify your preference for controller response using the **Controller response** slider.

- Move the slider to the left for aggressive control response.

This means that large overshoot is more heavily penalized so that the controller acts more aggressively. If you believe your model is accurate and that the manipulated variable has a large enough range, an aggressive controller is more desirable.

- Move the slider to the right for robust control response.

2 Specify your estimation of the level of measurement noise using the **Measurement noise** slider.

- Move the slider to the left for small measurement noise.

This means that you expect low noise from the process output measurement. Because this measurement is used by the Kalman estimator, process disturbances are picked up more accurately by the estimated states. In this case, the controller is freer from robustness considerations.

- Move the slider to the right for large measurement noise. This results in a controller that is more robust to measurement noise.

3 Specify your preference for controller order using the **Desired controller order** slider.

4 Click **Update Compensator**.

Loop Shaping

Loop shaping generates a stabilizing feedback controller to match as closely as possible to a desired loop shape. You can specify this loop shape as a bandwidth or an open loop frequency response. If you have Robust Control Toolbox software installed, you can use loop shaping for SISO systems. For more information see the section on H-Infinity Loop Shaping in the *Robust Control Toolbox User's Guide*.

To design a controller using loop shaping:

1 Select a tuning preference by clicking one of these option buttons:

- **Target bandwidth** — Allows you to specify a target loop shape bandwidth (ω_b). This results in a loop shape of your specified bandwidth

over an integrator ($\frac{\omega_b}{s}$).

- **Target loop shape** — Allows you to specify the target open loop shape in one of the following representations: state-space, zero-pole-gain, or transfer functions.

2 Set the tuning options available for your selected tuning preference as follows:

- If you chose **Target bandwidth**, specify the desired **Target open-loop bandwidth** in the editable box.

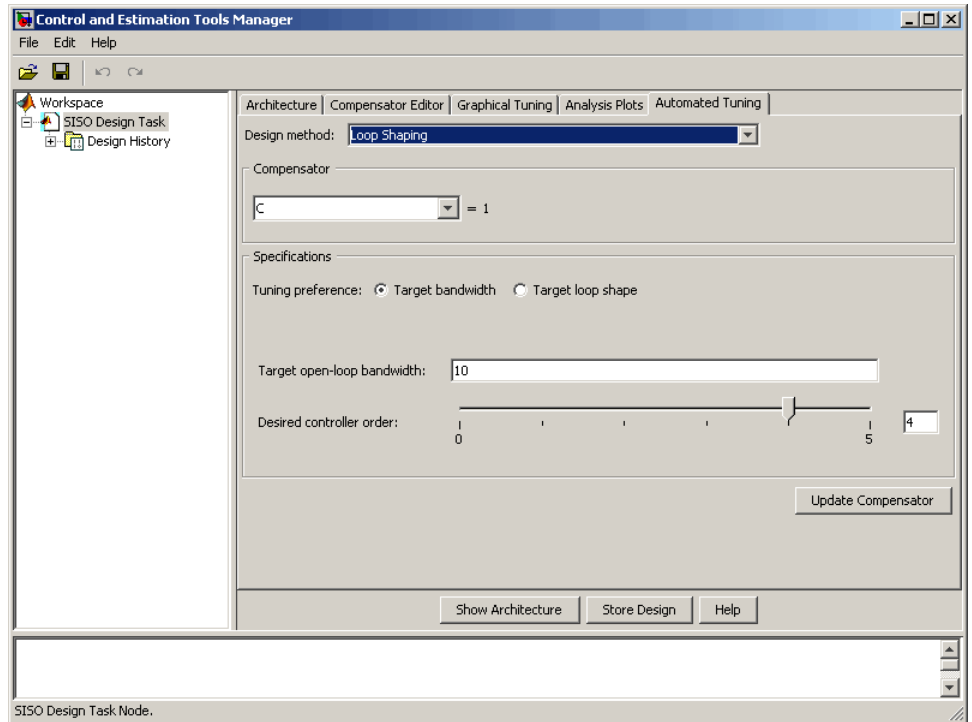

- If you chose **Target loop shape**, do the following:
 - Enter the desired **Target open-loop shape (LTI)**.
This can be a state-space representation, a zero-pole-gain representation, or a transfer function.
 - Enter the desired **Frequency range for loop shaping [wmin,wmax]**.

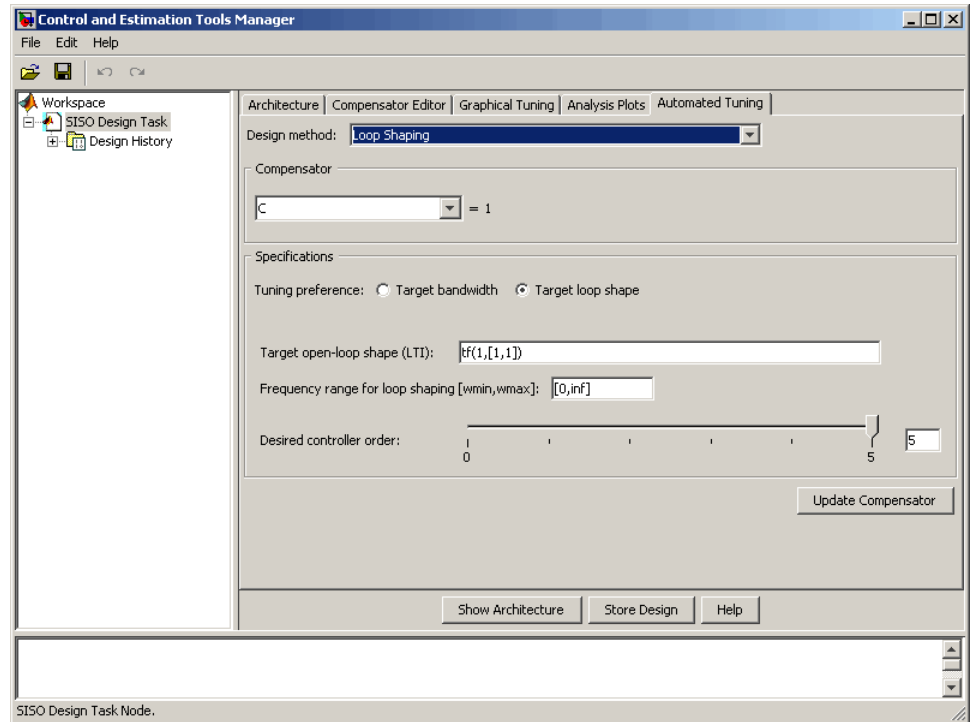

- 3 Specify your preference for controller order using the **Desired controller order** slider.
- 4 Click **Update Compensator**.

SISO Design Task Graphical Tuning Window

The following figure shows the Graphical Tuning window and introduces some terminology.

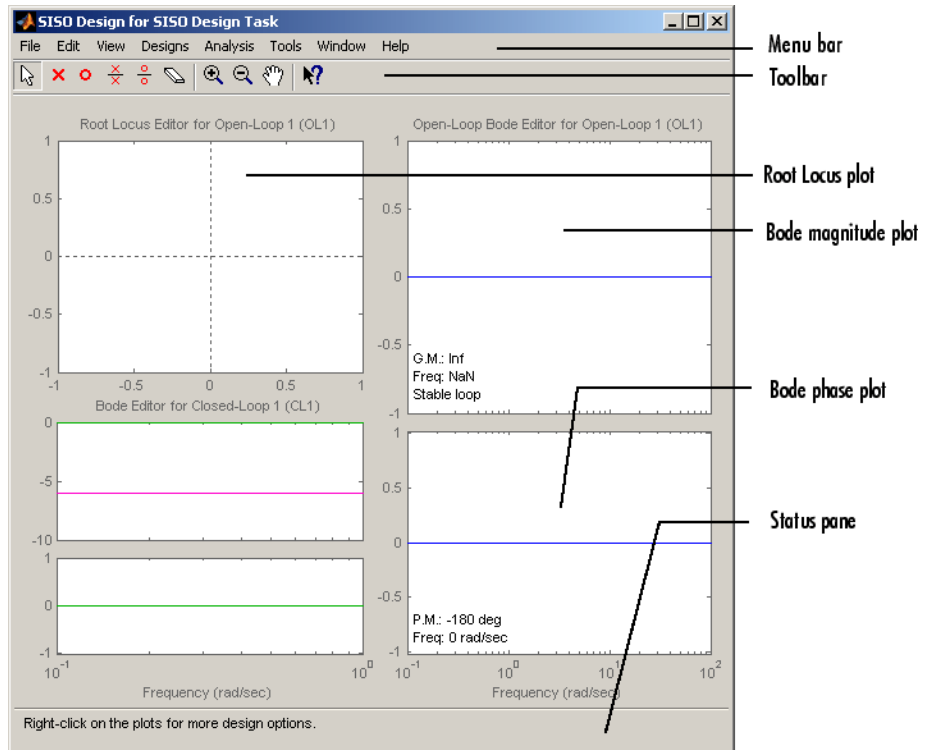

Graphical Tuning Window

Bode and Nichols plots in the graphical tuning window automatically display the following information:

- Gain margin and the -180 degree phase crossing frequency where it is measured
- Phase margin and the 0 dB gain crossing frequency where it is measured
- Whether the characteristic equation $1+L$ is stable (**Stable loop**) or unstable (**Unstable loop**). L is the open loop plotted in the figure.

For row or column arrays of LTI models, the plots display the characteristics of the nominal model only.

The following topics describe the Graphical Tuning window features:

- “Using the Graphical Tuning Window Menu Bar” on page 17-45
- “Using the Graphical Tuning Window Toolbar” on page 17-57
- “Using the Right-Click Menus in the Graphical Tuning Window” on page 17-58

Using the Graphical Tuning Window Menu Bar

In this section...

“Overview of the Graphical Tuning Window Menu Bar” on page 17-45

“File” on page 17-45

“Edit” on page 17-48

“View” on page 17-49

“Analysis” on page 17-50

“Tools” on page 17-51

“Window” on page 17-55

“Help” on page 17-55

Overview of the Graphical Tuning Window Menu Bar

Several of the tasks you can do in the SISO Design Tool can be done from the menu bar, shown below.

File Edit View Designs Analysis Tools Window Help

File

Import...	
Export...	
Save Session...	
Load Session...	
Toolbox Preferences...	
Print...	Ctrl+P
Print to Figure	
Close	Ctrl+W

Using the **File** menu, you can:

- Import and export models

- Save and reload sessions
- Set toolbox preferences
- Print and print to figure
- Close the Graphical Tuning Window

The following sections describe the **File** menu options in turn.

Import

Selecting **Import** opens the same System Data dialog box that clicking **System Data** on the **Architecture** pane does. See “Model Import” on page 17-15.

Export

Selecting **Export** from the Graphical Tuning window **File** menu opens the same SISO Tool Export window that selecting **Export** from the SISO Design Task node **File** menu does. See Export.

Save Session

Selecting **Save Session** from the Graphical Tuning window **File** menu opens the same Save Projects window that selecting **Save** from the SISO Design Task node **File** menu does. See Save.

Load Session

To load a saved SISO Design Tool session, select **Load Session** from the **File** menu. This opens the **Load Session** dialog.

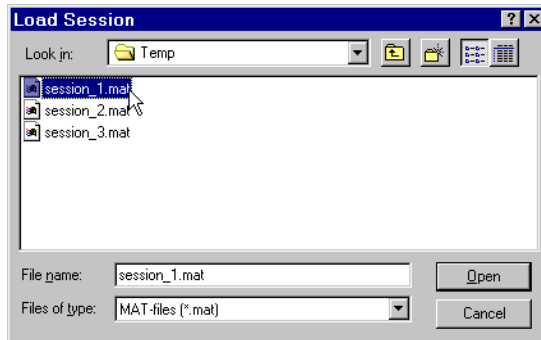

Sessions are saved as MAT-files. Select the session you want to load from the list, and click **Open**. See “Save Session” on page 17-46 for information on saving **SISO Design Tool** sessions.

Toolbox Preferences

Select **Toolbox Preferences** from the **File** menu to open the **Control System Toolbox Preferences** window.

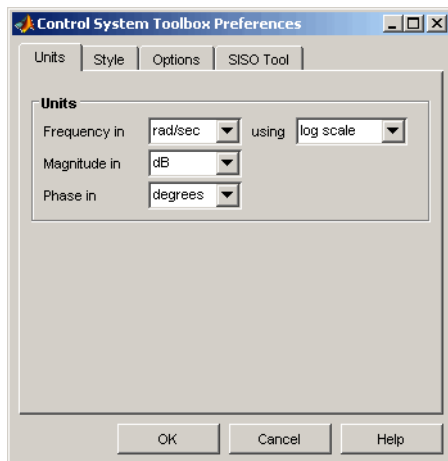

The Control System Toolbox Preferences Window

For a discussion of this window’s features, see "Setting Toolbox Preferences" online in the Control System Toolbox documentation.

Print

Use **Print** to send a picture of the Graphical Tuning window to your printer.

Print to Figure

Print to Figure opens a separate figure window containing the design views in your current Graphical Tuning window.

Close

Use **Close** to close the Graphical Tuning window.

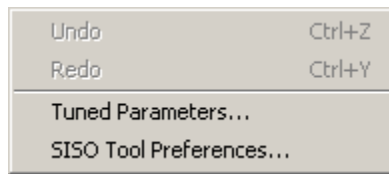
Edit**Undo and Redo**

Selecting **Undo** and **Redo** perform the same actions as selecting **Undo** and **Redo** from the **SISO Design Task Node Edit** menu. See “**Edit Menu Options**” on page 17-9.

Tuned Parameters

Selecting **Tuned Parameters** opens the SISO Tool Preferences dialog box on the **Options** page.

SISO Tool Preferences

Selecting the **SISO Tool Preferences** option opens the same dialog box that selecting SISO Tool Preferences from the Edit menu on the SISO Design Task Node. See “**Edit Menu Options**” on page 17-9.

View

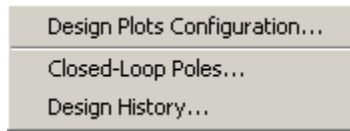

Design Plots Configuration

Select **Design Plots Configuration** to open the Graphical Tuning pane. See “Graphical Tuning” on page 17-20.

Closed-Loop Poles

Select **Closed-Loop Poles** from **View** to open the **Closed-Loop Pole Viewer**.

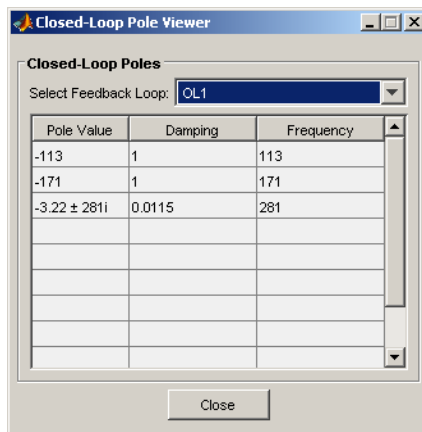

This window displays all the closed-loop pole values of the selected feedback loop and the associated damping and frequency values.

Design History

Select **Design History** from the **View** menu to open the **Design History** window, which displays all the actions you’ve performed during a design session. You can save the history to an ASCII flat text file by clicking **Save to Text File**.

Analysis

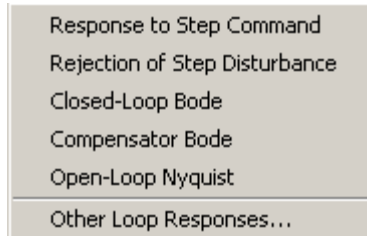

Common Response Plots

Each of the top group of items in the Analysis menu opens an LTI Viewer that is dynamically linked to your SISO Design Tool. You have the following response plot choices:

- **Response to Step Command** — The closed-loop step response of your system
- **Rejection of Step Disturbance** — The open-loop step response of your system
- **Closed-Loop Bode** — The closed-loop Bode diagram for your system
- **Compensator Bode** — The open-loop Bode diagram for your compensator
- **Open-Loop Nyquist** — The open-loop Nyquist plot for your system

When you make changes to the design via the Graphical Tuning window, the Compensator Editor pane, or the Automated Tuning pane, the response plots in the LTI Viewer automatically change to reflect the new design's responses.

Other Loop Responses

If you choose **Other Loop Responses**, the **Analysis Plots** pane opens. See "Analysis Plots" on page 17-24.

Tools

Continuous/Discrete Conversions...
 Draw Simulink Diagram...
 Automated Tuning...

Continuous/Discrete Conversions Using the Sample Time Conversion Dialog Box

- “Converting Continuous-Time Models to Discrete-Time Models” on page 17-51
- “Converting Discrete-Time Models to Continuous-Time” on page 17-52
- “Changing the Sample Time of a Discrete-Time Model” on page 17-53

Converting Continuous-Time Models to Discrete-Time Models. To convert a continuous-time model to a discrete-time model, perform these steps:

- 1** In the SISO Design Tool, select **Tools > Continuous/Discrete Conversions** to open the **Sample Time Conversion** window.

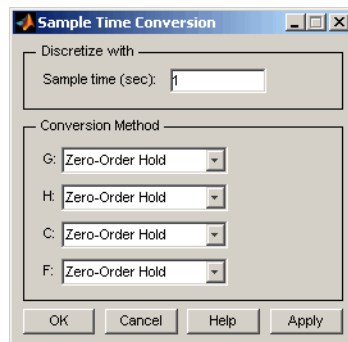

- 2** Specify a positive number for the sample time in the **Sample time (sec)** field.
- 3** Select a continuous-to-discrete conversion method for each component of your model. The components include the plant (**G**), the compensator (**C**), the prefilter (**F**), or the sensor (**H**). You can choose from the following conversion methods:

- Zero-order hold
- First-order hold
- Tustin
- Tustin with prewarping

Note If you choose Tustin with prewarping, you must specify the critical frequency in radians per second.

- Matched pole/zero

For more information on each of these conversion methods, see “Continuous-Discrete Conversion Methods” on page 5-19 in the Control System Toolbox documentation.

Converting Discrete-Time Models to Continuous-Time. To convert a discrete-time model to a continuous-time model, perform these steps:

- 1 In the SISO Design Tool, select **Tools > Continuous/Discrete Conversions** to open the **Sample Time Conversion** window.

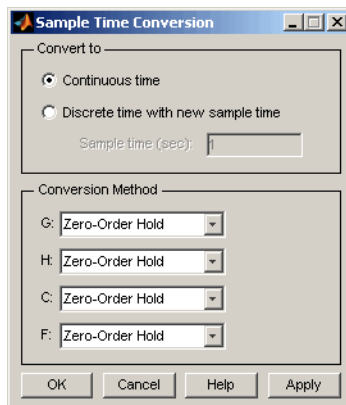

- 2 Select a discrete-to-continuous conversion method for each component of your model. The components include the plant (**G**), the compensator (**C**),

the prefilter (**F**), or the sensor (**H**). You can choose from the following conversion methods:

- Zero-order hold
- First-order hold
- Tustin
- Tustin with prewarping

Note If you choose Tustin with prewarping, you must specify the critical frequency in radians per second.

- Matched pole/zero

For more information on each of these conversion methods, see “Continuous-Discrete Conversion Methods” on page 5-19 in the Control System Toolbox documentation.

Changing the Sample Time of a Discrete-Time Model. To change the sample time of (resample) a discrete system, perform these steps:

- 1** In the SISO Design Tool, select **Tools > Continuous/Discrete Conversions** to open the **Sample Time Conversion** window.
- 2** Click the **Discrete time with new sample time** option button.

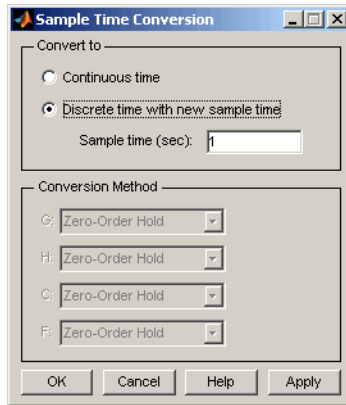

- 3 Specify a positive number for the sample time in the **Sample time (sec)** field.

Draw Simulink Diagram

Note You must have a license for Simulink to use this feature. If you do not have Simulink, this option does not appear under the **Tools** menu.

Select **Draw Simulink Diagram** from the Tools menu to draw a block diagram of your system (plant, compensator, prefilter, and sensor). The following diagram shows how the tool would render the DC motor example described in the *Control System Toolbox Getting Started Guide*.

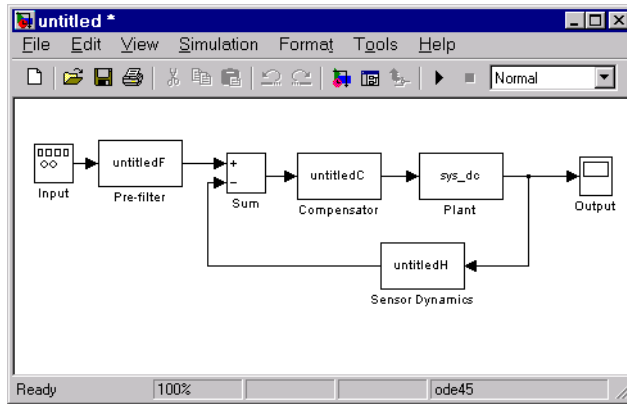

Automated Tuning

Select **Automated Tuning** from the Tools menu in the SISO Design Tool to open the **Automated Tuning** tab of the Control and Estimation Tools Manager. You can use this tab to perform automated tuning of compensators. For more information, see “Automated Tuning Design”.

Window

The **Window** menu item lists all of the windows open in the MATLAB technical computing environment. The first item is always the MATLAB Command Window. After that, the windows you have opened are listed in the order in which you opened them. Select any window from the list to make it the active window.

Help

Help brings you to various places in the Control System Toolbox help system. This figure shows the menu.

SISO Design Tool Help
Control System Toolbox Help
What's This?
Importing/Exporting Models
Tuning Compensators
Viewing Loop Responses
Viewing System Data
Storing/Retrieving Designs
Customizing the SISO Tool
Demos
About the Control System Toolbox

Each topic takes you to brief discussions of basic information about the SISO Design Tool and the Control System Toolbox software:

- **SISO Design Tool Help** — An overview of the SISO Design Tool
- **Control System Toolbox Help** — A roadmap for the Control System Toolbox help
- **What's This?** — Activates the "What's This?" cursor, which appears as a question mark. Click in various regions of the SISO Design Tool to see brief descriptions of the tool's features.
- **Importing/Exporting Models** — How to import models into the SISO Design Tool and how to export completed designs
- **Tuning Compensators** — Basic information about adjusting gains and adding dynamics to your prefilter (**F**) and compensator (**C**)
- **Viewing Loop Responses** — How to open an LTI Viewer containing loop responses for your system. Many response types are available.
- **Viewing System Data** — How to see information about your model
- **Storing/Retrieving Designs** — How to store and retrieve designed systems
- **Customizing the SISO Tool** — How to open the SISO Tool Preferences editor, which allows you to customize plot displays in the tool
- **Examples** — A link to Control System Toolbox featured examples
- **About the Control System Toolbox software** — The version number of your Control System Toolbox software

Using the Graphical Tuning Window Toolbar

The toolbar performs the following operations:

- Add and delete real and complex poles and zeros
- Zoom in and out
- Invoke the SISO Design Tool's context-sensitive help

This picture shows the toolbar.

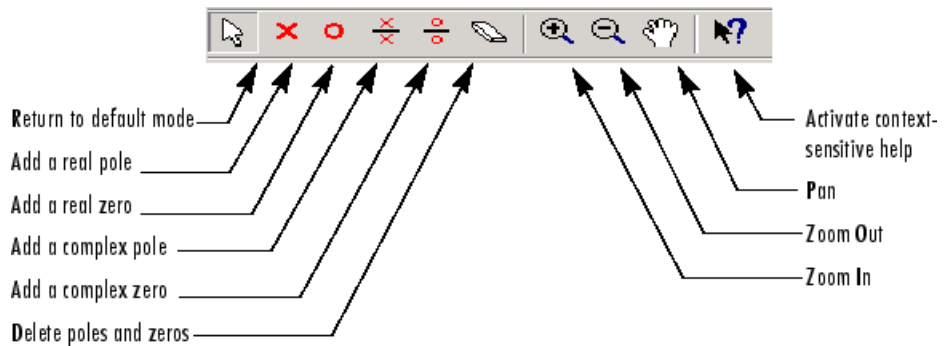

Options Available from the Toolbar

You can use the tool tips feature to find out what a particular icon does. Just place your mouse over the icon in question, and you will see a brief description of what it does.

Once you've selected an icon, your mouse stays in that mode until you press the icon again.

You can reach all of these options from the right-click menus.

Using the Right-Click Menus in the Graphical Tuning Window

In this section...

“Overview of the Right-Click Menus” on page 17-58

“Add Pole/Zero” on page 17-59

“Delete Pole/Zero” on page 17-62

“Edit Compensator” on page 17-63

“Gain Target” on page 17-63

“Show” on page 17-63

“Multimodel Display” on page 17-64

“Design Requirements” on page 17-64

“Grid” on page 17-77

“Full View” on page 17-77

“Properties” on page 17-78

“Select Compensator” on page 17-79

“Status Pane” on page 17-79

Overview of the Right-Click Menus

The Graphical Tuning window provides right-click menus for all the views available. These views include the root-locus, open-loop Bode diagrams, Nichols plot, and the closed-loop Bode diagrams. The menu items in each of these views are identical. The design requirements, however, differ, depending on which view you are accessing the menus from.

You can use the right-click menu to design a compensator by adding poles, zeros, lead, lag, and notch filters. In addition, you can use this menu to add grids and zoom in on selected regions. Also, you can open each view’s **Property Editor** to customize units and other elements of the display.

Note Click items on the menu bar pictured below to get help contents.

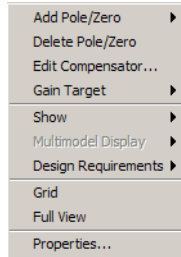

Open-Loop Right-Click Menu

Note that if you have a closed-loop response, the Gain Target menu item is replaced by “Select Compensator” on page 17-79.

Add Pole/Zero

The **Add Pole/Zero** menu options give you the ability to add dynamics to your compensator design, including poles, zeros, lead and lag networks, and notch filters. The following pole/zero configurations are available:

- **Real Pole**
- **Complex Pole**
- **Integrator**
- **Real Zero**
- **Complex Zero**
- **Differentiator**
- **Lead**
- **Lag**
- **Notch**

In all but the integrator and differentiator, once you select the configuration, your cursor changes to an ‘x’. To add the item to your compensator design,

place the x at the desired location on the plot and left-click your mouse. You will see the root locus design automatically update to include the new compensator dynamics.

The notch filter has three adjustable parameters. For a discussion about how to add and adjust notch filters, see "Adding a Notch Filter" in the *Control System Toolbox Getting Started Guide*.

Note For systems with FRD plants, you cannot add or modify poles and zeros outside the plotted frequency range on Bode and Nichols plots. Instead, you can make such modifications using the Compensator Editor pane of the Control and Estimation Tools Manager. For more information, see "Compensator Editor" on page 17-19.

Example: Adding a Complex Pair of Poles

This example shows you how to add a complex pair of poles to the open-loop Bode diagram. First, type

```
load ltiexamples  
sisotool('bode',sys_dc)
```

at the MATLAB prompt. This opens the SISO Design Tool with the DC motor example loaded and the open-loop Bode diagram displayed in the Graphical Tuning window.

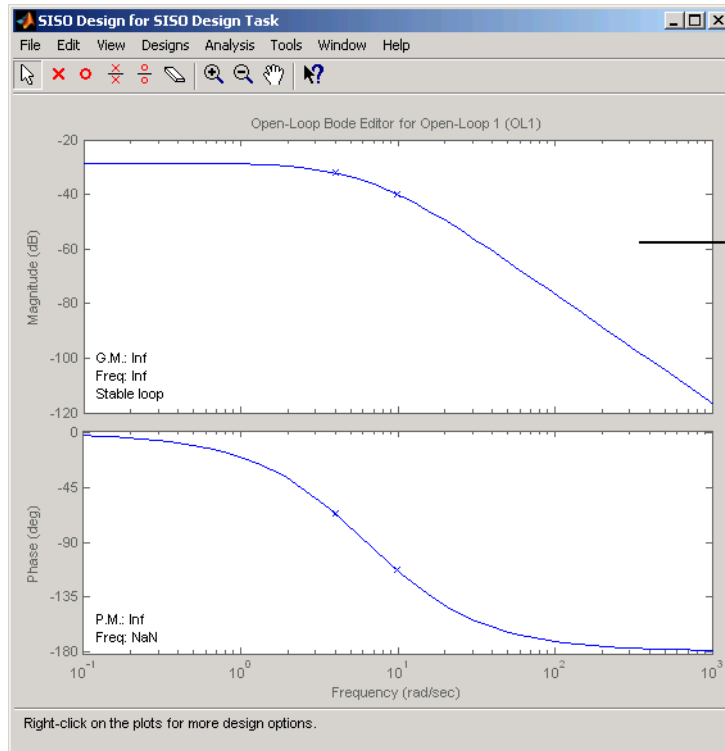

To add a complex pair of poles:

- 1** Select **Add Pole/Zero->Complex Pole** from the right-click menu
- 2** Place the mouse cursor where you want the pole to be located
- 3** Left-click to add the pole

Your Graphical Tuning window should look similar to this.

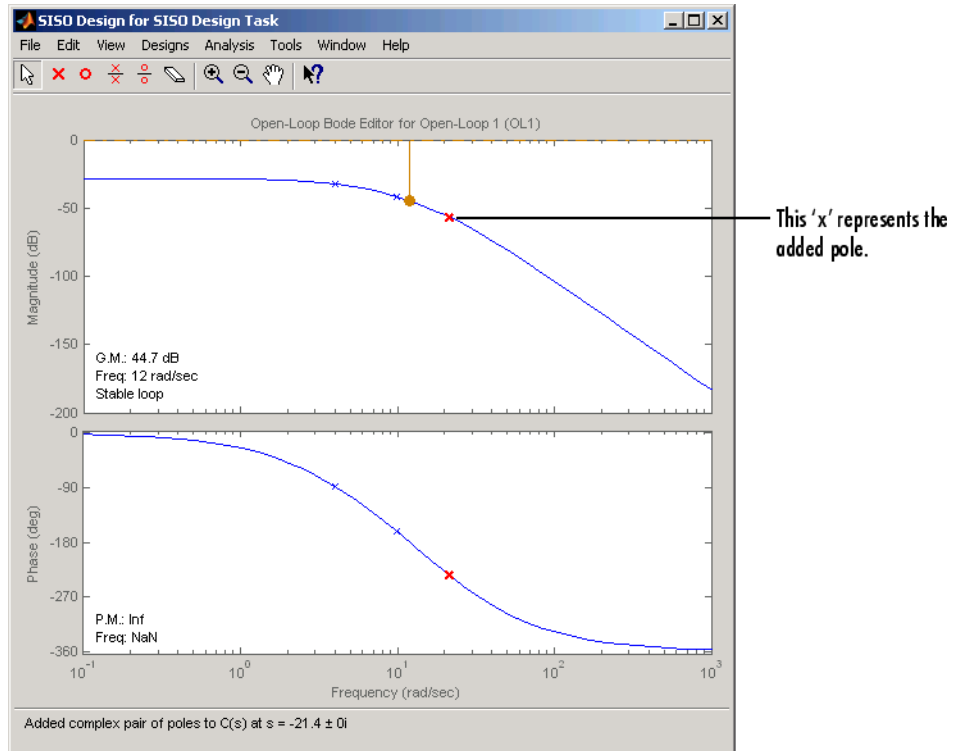

In the case of Bode diagrams, when you place a complex pole, the default damping value is 1, which means you have a double real pole. To change the damping, grab the red 'x' by left-clicking on it and drag it upward with your mouse. You will see damping ratio change in the Status pane at the bottom of the SISO Design Tool.

Delete Pole/Zero

Select **Delete Pole/Zero** to delete poles and zeros from your compensator design. When you make this selection, your cursor changes to an eraser. Place the eraser over the pole or zero you want to delete and left-click your mouse.

Note the following:

- You can only delete compensator poles and zeros. Plant (**G** in the feedback structure pane) poles and zeros cannot be altered.
- If you delete one of a pair of poles or zeros, the other member of the pair is also removed.

Edit Compensator

Edit Compensator opens the **Compensator Editor** pane in the SISO Design Task. You can use this pane to adjust the compensator gain and add or remove compensator poles and zeros from your compensator (**C**) or prefilter (**F**) design. See “Compensator Editor” on page 17-19 for a discussion of this pane.

Gain Target

This feature is intended for users of the Simulink Control Design software. It is nonfunctional in the Control System Toolbox software.

Show

Use **Show** to select/deselect the display of characteristics relevant to which view you are working with. This figure displays the Show submenu for the open-loop Bode diagram.

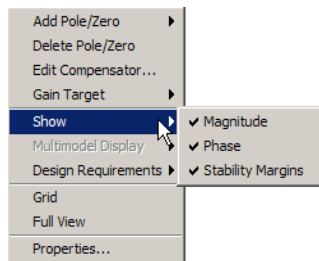

For this particular view, the options available are magnitude, phase, and stability margins. Selecting any of these toggles between showing and hiding the feature. A check next to the feature means that it is currently displayed on the Bode diagram plots. Although the characteristics are different for each view in the Graphical Tuning window, they all toggle on and off in the same manner.

Multimodel Display

This menu is enabled only when you import or open the SISO Design Tool with row or column arrays of LTI models.

Use **Multimodel Display** to view the responses of models in an LTI array as individual responses or as an envelope encompassing all responses on the Bode and Nichols plots.

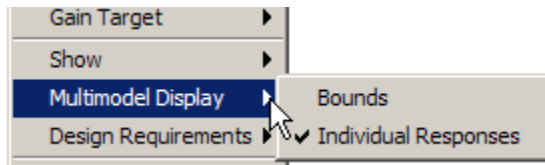

On the Root Locus plot, use this menu to show or hide the pole/zero locations of all models in the array, except the nominal one.

For more information on control design analysis for multiple models, see “Control Design Analysis of Multiple Models” in the Getting Started Guide.

Design Requirements

When designing compensators, it is common to have design specifications that call for specific settling times, damping ratios, and other characteristics. The Graphical Tuning window provides tools for design requirements that can help make the task of meeting design specifications easier.

The New Design Requirement dialog box lets you create design requirements by creating graphical representations for feasible and nonfeasible regions, automatically changes to reflect which design requirements are available for the view in which you are working. Select **Design Requirements > New** to open the New Design Requirement dialog box.

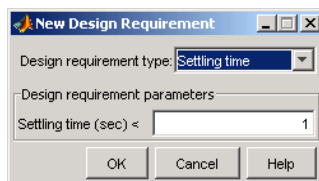

Since each view has a different set of design requirements, click the following links to go to the appropriate descriptions:

- “Design Requirements for the Root Locus” on page 17-65
- “Design Requirements for Open- and Closed-Loop Bode Diagrams” on page 17-68
- “Design Requirements for Open-Loop Nichols Plots” on page 17-72
- “LTI Viewer for SISO Design Task Design Requirements” on page 17-80

For row or column arrays of LTI models, the design requirements are for the nominal plant that you are designing the controller for. You can analyze the effects of this controller on the remaining models. See “Control Design Analysis of Multiple Models” in the Getting Started Guide.

Design Requirements for the Root Locus

For the root locus, you can use the following design requirements:

- “Settling Time” on page 17-65
- “Percent Overshoot” on page 17-66
- “Damping Ratio” on page 17-66
- “Natural Frequency” on page 17-66
- “Region Constraint” on page 17-66

Use the **Design requirement type** drop-down list to select a design requirement. In each case, to specify the design requirement, enter the value in the **Design requirement parameters** pane. You can select any or all of them, or have more than one of each.

Settling Time. If you specify a settling time in the continuous-time root locus, a vertical line appears on the root locus plot at the pole locations associated with the settling time value provided (using a first-order approximation). This vertical line is exact for a second order system and is only an approximation for higher order systems. In the discrete-time case, the design requirement boundary is a curved line.

Percent Overshoot. Specifying percent overshoot in the continuous-time root locus causes two rays, starting at the root locus origin, to appear. These rays are the locus of poles associated with the percent value (using a second-order approximation). In the discrete-time case, the design requirement appears as two curves originating at (1,0) and meeting on the real axis in the left-hand plane.

Note that the percent overshoot (p.o.) design requirement can be expressed in terms of the damping ratio, as in this equation:

$$p.o. = 100 \exp\left(-\frac{\pi\zeta}{\sqrt{1-\zeta^2}}\right)$$

where ζ is the damping ratio.

Damping Ratio. Specifying a damping ratio in the continuous-time root locus causes two rays, starting at the root locus origin, to appear. These rays are the locus of poles associated with the damping ratio. In the discrete-time case, the design requirement boundary appears as curved lines originating at (1,0) and meeting on the real axis in the left-hand plane.

Natural Frequency. If you specify a natural frequency lower bound, a semicircle centered around the root locus origin appears. If you specify a natural frequency upper bound, the inverse of this semicircle appears. The radius equals the natural frequency.

Region Constraint. Specifying a region constraint at given locations causes black lines and a yellow area to appear. The vertices of this free-form piecewise region are defined by the specified real and imaginary values.

Example: Adding Damping Ratio Design Requirements

This example adds a damping ratio design requirement of 0.707.

1 At the MATLAB prompt, type the following:

```
load ltexamples
sisotool(sys_dc)
```

This opens the SISO Design Tool with the DC motor example imported.

- 2 From the root locus right-click menu, select **Design Requirement** > **New** to open the New Design Requirement dialog box.
- 3 To add the design requirement, select **Damping Ratio** as the design requirement. Click **OK** to accept the default damping ratio of 0.707.

The Graphical Tuning window should now look similar to this figure.

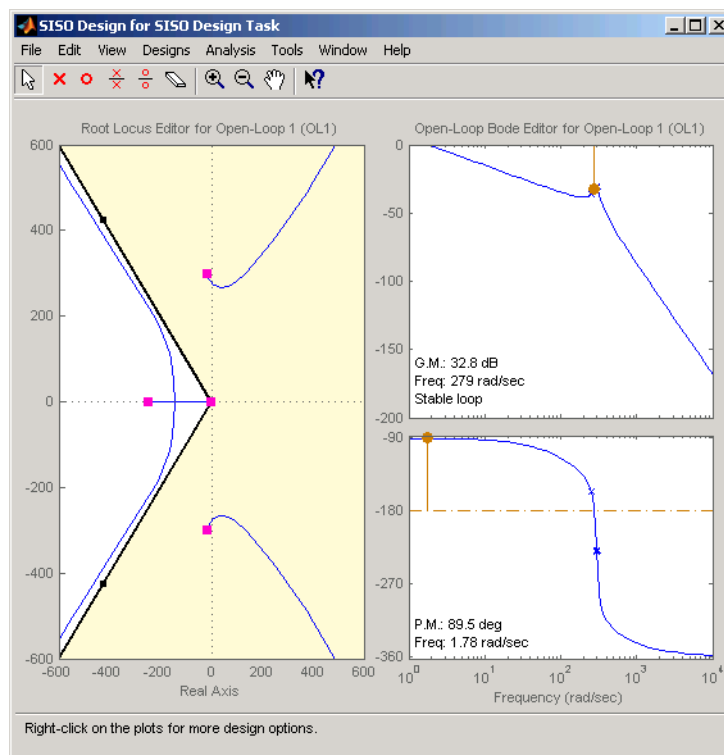

Damping Ratio Requirements in the Root Locus

The two rays centered at (0,0) represent the damping ratio boundaries. The dark edge is the region boundary, and the shaded area outlines the exclusion region. This figure explains what this means for this design requirement.

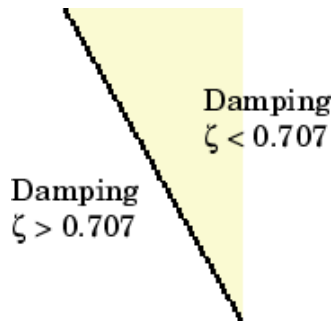

You can, for example, use this design requirement to ensure that the closed-loop poles, represented by the red squares, have some minimum damping. Try adjusting the gain until the damping ratio of the closed-loop poles is 0.7.

Design Requirements for Open- and Closed-Loop Bode Diagrams

For both the open- and closed-loop Bode diagrams, you have the following options:

- “Upper Gain Limit” on page 17-68
- “Lower Gain Limit” on page 17-69
- “Gain and Phase Margin” on page 17-69

Specifying any of these design requirements causes lines to appear in the Bode magnitude curve. To specify an upper or lower gain limit, enter the frequency range, the magnitude limit, and/or the slope in decibels per decade, in the appropriate fields of the New design requirement dialog box. You can have as many gain limit design requirements as you like in your Bode magnitude plots.

Upper Gain Limit. You can specify one or multiple piecewise linear upper gain limits over a frequency range, which appear as straight lines on the Bode magnitude curve. You must select frequency limits, the upper gain limit in decibels, and the slope in dB/decade.

Lower Gain Limit. You can specify one or multiple lower gain limit in the same fashion as the upper gain limit.

Gain and Phase Margin. You can specify a lower bound for the gain, the phase margin, or both. The specified bounds appear in text on the Bode magnitude plot.

Example: Adding Upper Gain Limits

This example shows you how to add two upper gain limit requirements to the open-loop Bode diagram.

- 1** At the MATLAB prompt, type the following:

```
load ltiexamples  
sisotool('bode',Gservo)
```

This opens the SISO Design Tool with the servomechanism model loaded.

- 2** Use the right-click menu to add a grid.

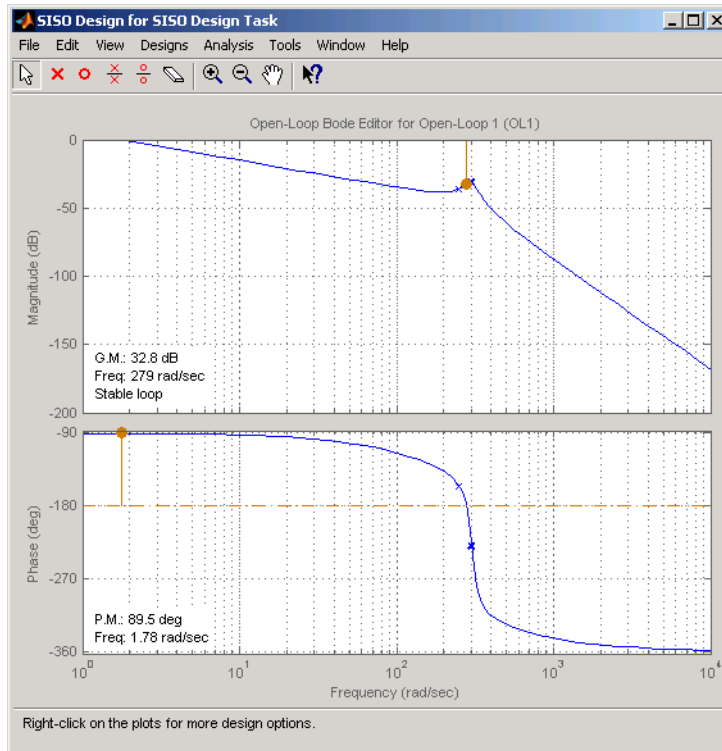

- 3 To add an upper gain limit requirement of 0 dB from 10 rad/sec to 100 rad/sec, open the New Design Requirement dialog box and select **Upper gain limit** from the pull-down menu. Fill in the dialog box fields as shown in the following figure.

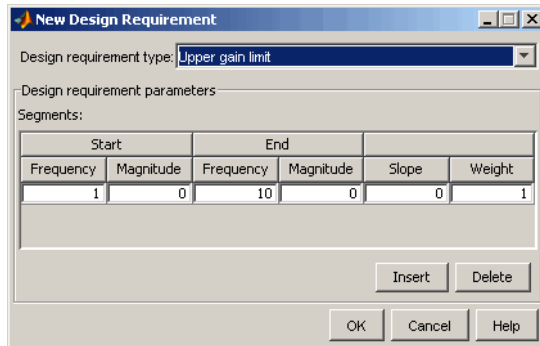

Your Graphical Tuning window should now look like this (you may have to adjust some axis limits).

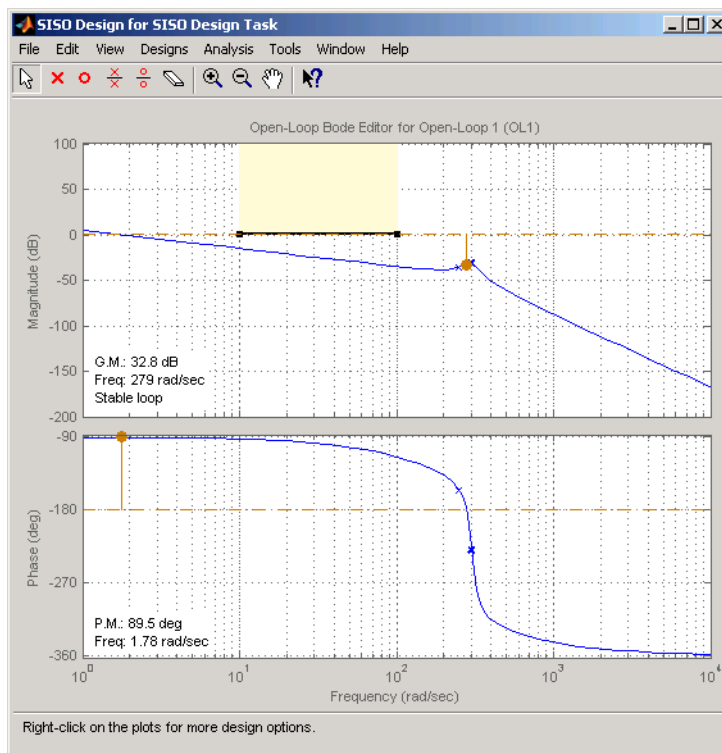

- 4 To constrain the roll off, open the New Design Requirement dialog box and add an upper gain limit from 100 rad/sec to 1000 rad/sec with a slope of -20 db/decade. This figure shows the result.

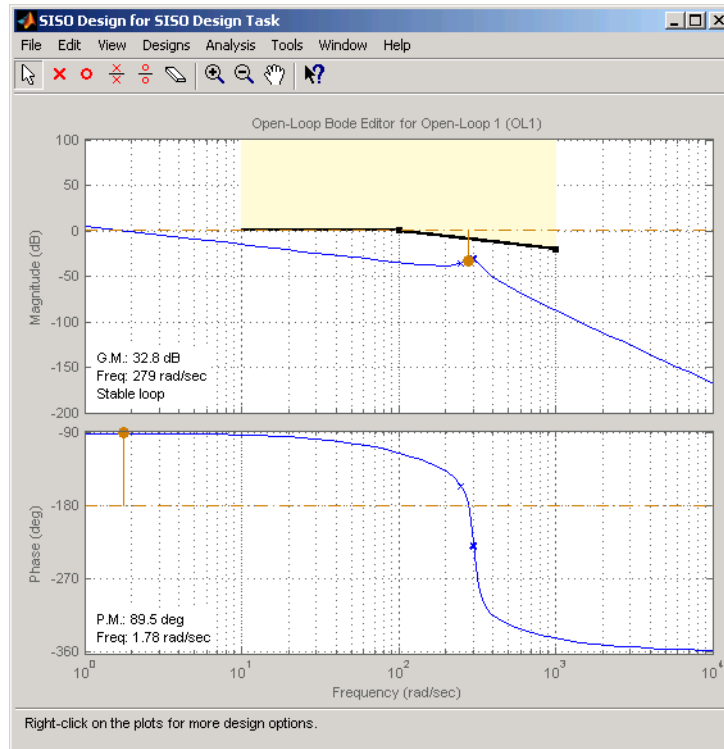

With these design requirements in place, you can see how much you can increase the compensator gain and still meet design specifications.

Note that you can change the design requirements by moving them with your mouse. See “Editing Design Requirements” on page 17-75 for more information.

Design Requirements for Open-Loop Nichols Plots

For open-loop Nichols plots, you have the following design requirement options:

- “Phase Margin” on page 17-73
- “Gain Margin” on page 17-73
- “Closed-Loop Peak Gain” on page 17-73
- “Gain-Phase Design Requirement” on page 17-73

Specifying any of these design requirements causes lines or curves to appear in the Nichols plot. In each case, to specify the design requirement, enter the value in the **Design requirement parameters** pane. You can select any or all of them, or have more than one of each.

Phase Margin. Specify a minimum phase margin at a given location. For example, you can require a minimum of 30 degrees at the -180 degree crossover. The phase margin specified should be a number greater than 0. The location must be a -180 plus a multiple of 360 degrees. If you enter an invalid location point, the closest valid location is selected.

Gain Margin. Specify a gain margin at a given location. For example, you can require a minimum of 20 dB at the -180 degree crossover. The location must be -180 plus a multiple of 360 degrees. If you enter an invalid location point, the closest valid location is selected.

Closed-Loop Peak Gain. Specify a peak closed-loop gain at a given location. The specified dB value can be positive or negative. The design requirement follows the curves of the Nichols plot grid, so it is recommended that you have the grid on when using this feature.

Gain-Phase Design Requirement. Specify both a gain and phase design requirement at a given location. The vertices of this free-form piecewise region are defined by the specified open-loop phase and open-loop gain values.

Example: Adding a Closed-Loop Peak Gain Design Requirement

This example shows how to add a closed-loop peak gain design requirement to the Nichols plot.

1 At the MATLAB prompt, type the following:

```
load ltiexamples
```

```
sisotool('nichols',Gservo)
```

This opens the SISO Design Tool with Gservo imported as the plant.

- 2 Use the right-click menu to add a grid, as this figure shows.

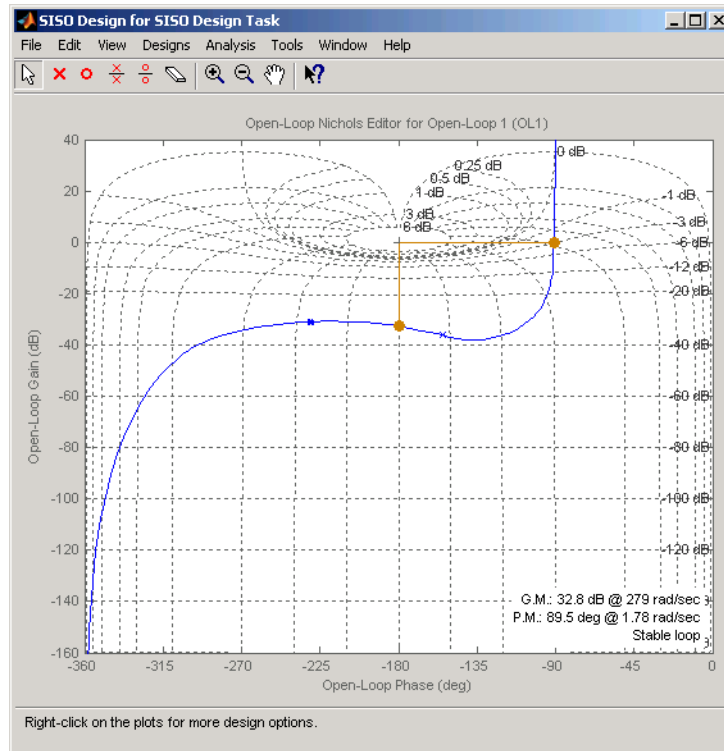

- 3 To add closed-loop peak gain of 1 dB at -180 degrees, open the New Design Requirement dialog box and select **Closed-Loop Peak Gain** from the pull-down menu. Set the peak gain field to 1 dB.

The figure shows the resulting design requirement.

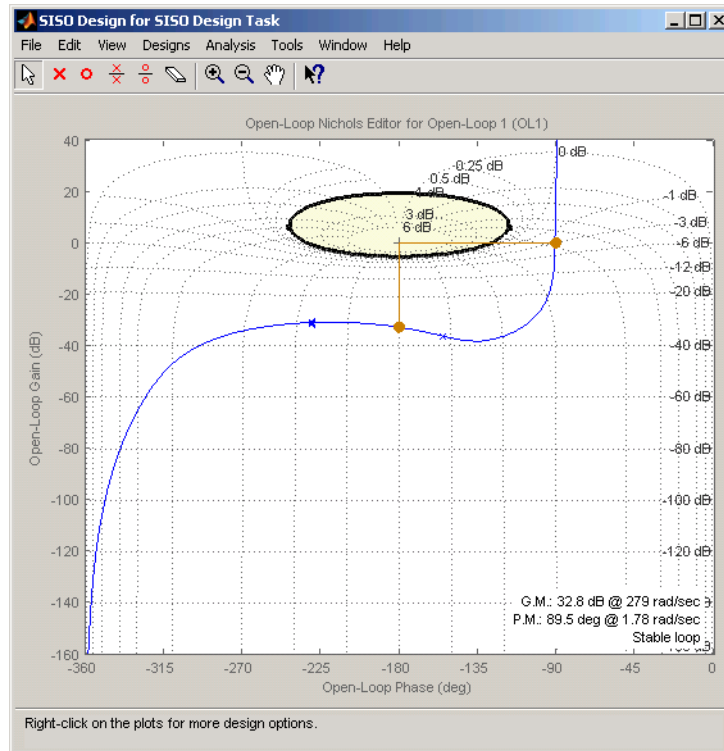

As long as the curve is outside of the gray region, the closed-loop gain is guaranteed to be less than 1 dB. Note that this is equivalent, up to second order, to specifying the peak overshoot in the time domain. In this case, a 1 dB closed-loop peak gain corresponds to an overshoot of 15%.

Editing Design Requirements

To edit an existing design requirement, left-click on the design requirement boundary to select it. Two black squares appear on the design requirement when it is selected. In general, there are two ways to adjust a design requirement:

- Click on the design requirement boundary and drag it. Generally, this does not change the shape of the boundary. That is, the adjustment is strictly a translation of the design requirement.

- Grab a black square and drag it. In this case, you can rotate, expand, and/or contract the design requirement.

For example, in Bode diagrams you can move an upper gain limit by clicking on it and moving it anywhere in the plot region. As long as you haven't grabbed a black square, the length and slope of the gain limit will not change as you move the line. On the other hand, you can change the slope of the upper gain limit by grabbing one of the black squares and rotating the line. In all cases, the Status pane at the bottom of the Graphical Tuning window displays the design requirement values as they change.

This figure shows the process of editing an upper gain limit in the open-loop Bode diagram.

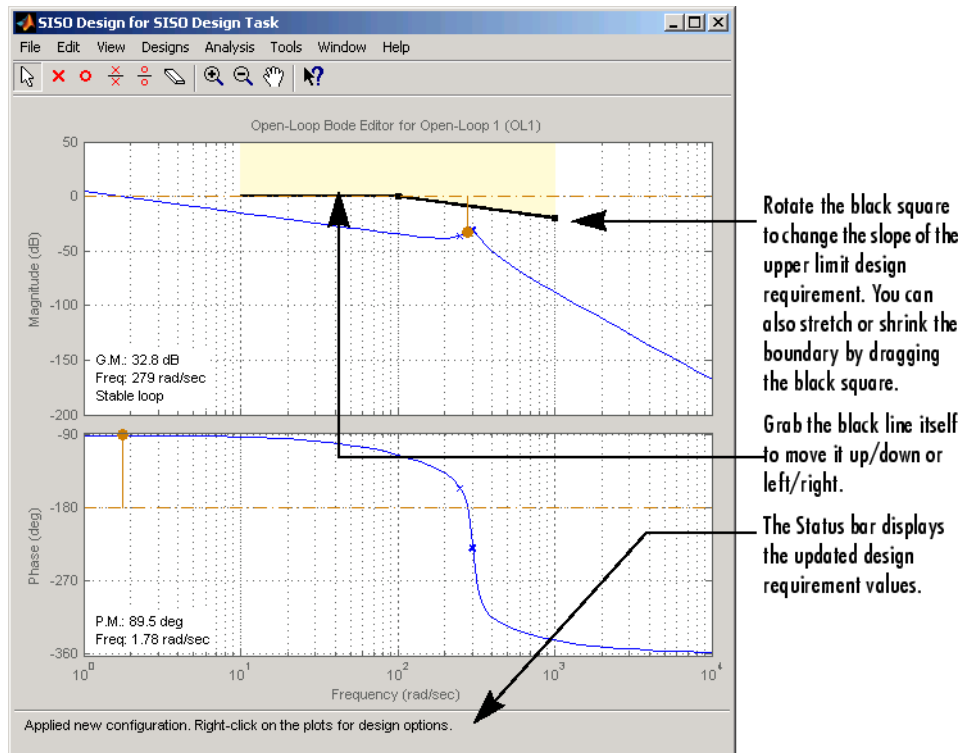

An alternative way to adjust a design requirement is to select **Design Requirements->Edit** from the right-click menu. The **Edit Design Requirement** window opens.



To adjust a design requirement, select the boundary by clicking on it and change the values in the fields of the Design requirement parameters pane. If you have additional design requirement in, for example, the Bode diagram, you can edit them directly from this window by selecting **Open-Loop Bode** from the **Editor** menu.

Deleting Design Requirements

To delete a design requirement, place your cursor directly over the design requirement yellow region. Right-click to open a menu containing **Edit** and **Delete**. Select **Delete** from the menu list; this eliminates the design requirement. You can also delete design requirements by left-clicking on a design requirement boundary and then pressing the **BackSpace** or **Delete** key on your keyboard.

Finally, you can delete design requirements by selecting **Undo Add Design Requirement** from the **Edit** menu, or pressing **Ctrl+Z** if adding design requirements was the last action you took.

Grid

Grid adds a grid to the selected plot.

Full View

Selecting **Full View** causes the plot to scale limits so that the entire curve is visible.

Properties

Properties opens the **Property Editor**, which is a GUI for customizing root locus, Bode diagrams, and Nichols plots inside the Graphical Tuning window. The Property Editor automatically reconfigures as you select among the different plots open.

This picture shows the open window for the root locus.

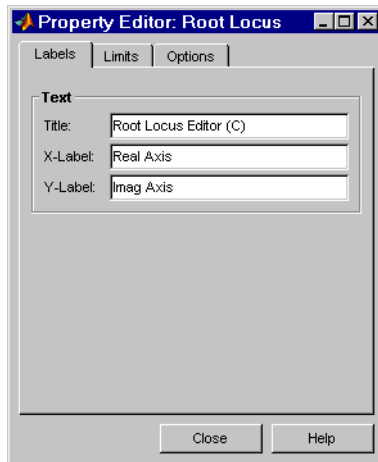

You can use this window to change titles and axis labels, reset axes limits, add grid lines, and change the aspect ratio of the plot. Note that you can also activate this menu by double-clicking anywhere in the root locus away from the curve.

There are only three panes in the Property Editor: Labels, Limits, and Options. The configuration of each page differs, depending on whether you're working with the root-locus, Bode diagrams, or the open-loop Nichols plot. Click the **Help** button on the Property Editor you have open to view information specific to that editor, or click on the links below:

- [Root locus](#)
- [Bode diagram](#)
- [Nichols plot](#)

Select Compensator

This option allows you to select which compensator to edit for closed-loop Bode response.

Status Pane

The Status pane is located at the bottom of the Graphical Tuning window. It displays the most recent action you have performed, occasionally provides advice on how to use the window, and tracks key parameters when moving objects in the design views.

LTI Viewer for SISO Design Task Design Requirements

In this section...

“Overview of LTI Viewer Design Requirements” on page 17-80

“Available Design Requirements in the LTI Viewer” on page 17-80

“Example: Time Domain Requirement” on page 17-81

Overview of LTI Viewer Design Requirements

You can use the LTI Viewer for SISO Design Tasks to specify both time and frequency domain requirements in analysis plots. Adding and editing design requirements is similar to those illustrated in the Graphical Tuning window.

Note To add design requirements, you must open the LTI Viewer from the SISO Design Task in the Control and Estimation Tools Manager. Design requirements are not available from an LTI Viewer that is opened using the `ltiview` command.

For row or column arrays of LTI models, the design requirements are for the nominal model that you are designing the controller for. You can analyze the effects of this controller on the remaining models. See “Control Design Analysis of Multiple Models” in the Getting Started Guide.

Available Design Requirements in the LTI Viewer

The design requirements for Bode, Root Locus, and Nichols plots can be applied to both graphical tuning windows and the LTI viewer. See “Design Requirements” on page 17-64 for information on graphical tuning design requirements.

You can also specify the following design requirements for both step and impulse response plots:

- **Upper time response bounds** — Creates an upper amplitude bound for a specified time duration.

- **Lower time response bounds** — Creates a lower amplitude bound for a specified time duration.

If you are using a step response plot, you can also specify the following design requirement:

- **Step response bounds** — Creates a group of upper and lower time response bounds, in the shape of a step response envelope, to encompass your specified design requirement parameters.

Example: Time Domain Requirement

This example shows you how to create a lower bound time response design requirement.

- 1 At the MATLAB prompt, type the following:

```
load ltiexamples
sisotool(Gservo)
```

- 2 From the **Analysis Plot** pane, select step response. See “Analysis Plots” on page 17-24 if you are unfamiliar with this task.
- 3 Select Design Requirements->New from the LTI Viewer right-click menu.
- 4 Select Lower time response bound from the Design requirements menu.
- 5 Set Time from 0.1 to 0.5 s.
- 6 Set Amplitude from 0 to 0.8. Your New Design Requirement window should look like this.

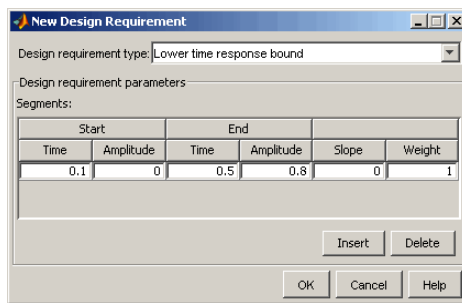

- 7 Click OK. This adds the design requirement. Your step response should look like this.

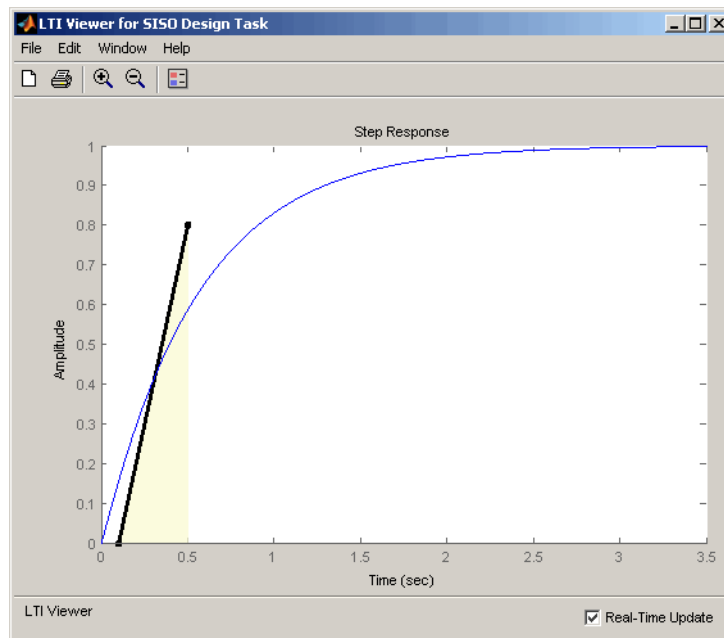

LTI Viewer

- “LTI Viewer Overview” on page 18-2
- “Using the Right-Click Menu in the LTI Viewer” on page 18-4
- “Importing, Exporting, and Deleting Models in the LTI Viewer” on page 18-12
- “Selecting Response Types” on page 18-16
- “Analyzing MIMO Models” on page 18-20
- “Customizing the LTI Viewer” on page 18-25

LTI Viewer Overview

LTI Viewer is a graphical user interface (GUI) that simplifies the analysis of linear, time-invariant systems. You use the LTI Viewer to view and compare the response plots of SISO and MIMO systems, or of several linear models at the same time. You can generate time and frequency response plots to inspect key response parameters, such as rise time, maximum overshoot, and stability margins.

The easiest way to work with the LTI Viewer is to use the right-click menus. For example, type

```
load ltiexamples
ltiview(sys_dc)
```

at the MATLAB prompt. The default plot is a step response.

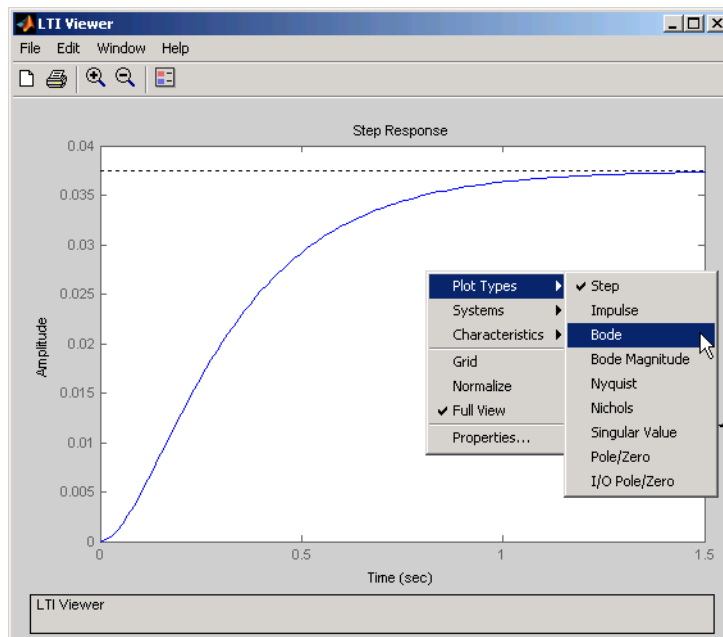

The LTI Viewer can display up to seven different plot types simultaneously, including step, impulse, Bode (magnitude and phase or magnitude only), Nyquist, Nichols, sigma, pole/zero, and I/O pole/zero.

See `ltiview` for help on the function that opens an LTI Viewer. For examples of how to use the LTI Viewer, see “Linear Analysis Using the LTI Viewer”.

For more information about LTI Viewer menus and options, see:

- “Using the Right-Click Menu in the LTI Viewer” on page 18-4
- “Importing, Exporting, and Deleting Models in the LTI Viewer” on page 18-12
- “Selecting Response Types” on page 18-16
- “Analyzing MIMO Models” on page 18-20
- “Customizing the LTI Viewer” on page 18-25

Using the Right-Click Menu in the LTI Viewer

In this section...

“Overview of the Right-Click Menu” on page 18-4

“Setting Characteristics of Response Plots” on page 18-4

“Adding Design Requirements” on page 18-9

Overview of the Right-Click Menu

The quickest way to manipulate views in the LTI Viewer is use the right-click menu. You can access several LTI Viewer controls and options, including:

- **Plot Type** — Changes the plot type
- **Systems** — Selects or deselects any of the models loaded in the LTI Viewer
- **Characteristics** — Displays key response characteristics and parameters
- **Grid** — Adds grids to your plot
- **Properties** — Opens the **Property Editor**, where you can customize plot attributes
- **Design Requirements** — Opens the New Design Requirement window for adding step response design requirements to your plot (available only for LTI Viewers linked to the Graphical Tuning window of the SISO Design Tool)

In addition to right-click menus, all response plots include data markers. These allow you to scan the plot data, identify key data, and determine the source system for a given plot.

Setting Characteristics of Response Plots

The **Characteristics** menu changes for each plot response type. Characteristics refers to response plot information, such as peak response, or, in some cases, rise time and settling time.

The next sections describe the menu items for each of the eight plot types.

Step Response

Step plots the model's response to a step input.

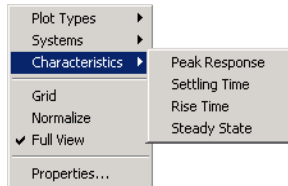

You can display the following information in the step response:

- **Peak Response** — The largest deviation from the steady-state value of the step response
- **Settling Time** — The time required for the step response to decline and stay at 5% of its final value
- **Rise Time** — The time require for the step response to rise from 10% to 90% of its final value
- **Steady-State** — The final value for the step response

Note You can change the definitions of settling time and rise time using the **Characteristics** pane of the Control System Toolbox editor, the LTI Viewer editor, or the Property editor.

Impulse Response

Impulse Response plots the model's response to an impulse.

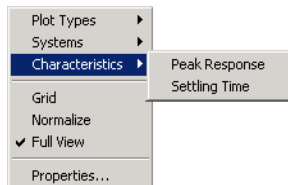

The LTI Viewer can display the following information in the impulse response:

- **Peak Response** — The maximum positive deviation from the steady-state value of the impulse response
- **Settling Time** — The time required for the step response to decline and stay at 5% of its final value

Bode Diagram

Bode plots the open-loop Bode phase and magnitude diagrams for the model.

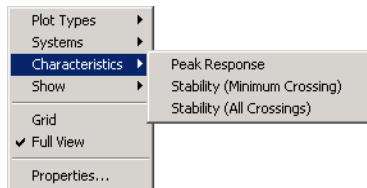

The LTI Viewer can display the following information in the Bode diagram:

- **Peak Response** — The maximum value of the Bode magnitude plot over the specified region
- **Stability Margins (Minimum Crossing)** — The minimum phase and gain margins. The gain margin is defined to the gain (in dB) when the phase first crosses -180° . The phase margin is the distance, in degrees, of the phase from -180° when the gain magnitude is 0 dB.
- **Stability Margins (All Crossings)** — Display all stability margins

Bode Magnitude

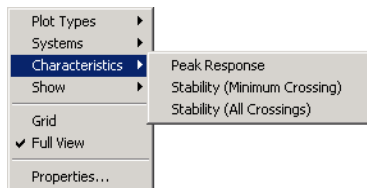

Bode Magnitude plots the Bode magnitude diagram for the model.

The LTI Viewer can display the following information in the Bode magnitude diagram:

- **Peak Response**, which is the maximum value of the Bode magnitude in decibels (dB), over the specified range of the diagram.
- **Stability (Minimum Crossing)** — The minimum gain margins. The gain margin is defined to the gain (in dB) when the phase first crosses -180° .
- **Stability (All Crossings)** — Display all gain stability margins

Nyquist Diagrams

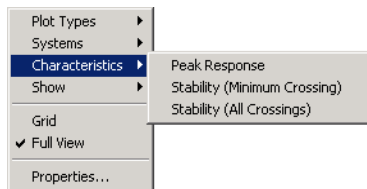

Nyquist plots the Nyquist diagram for the model.

The LTI Viewer can display the following types of information in the Nyquist diagram:

- **Peak Response** — The maximum value of the Nyquist diagram over the specified region
- **Stability (Minimum Crossing)** — The minimum gain and phase margins for the Nyquist diagram. The gain margin is the distance from the origin to the phase crossover of the Nyquist curve. The phase crossover is where the curve meets the real axis. The phase margin is the angle subtended by the real axis and the gain crossover on the circle of radius 1.
- **Stability (All Crossings)** — Display all gain stability margins

Nichols Charts

Nichols plots the Nichols Chart for the model.

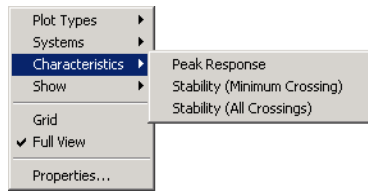

The LTI Viewer can display the following types of information in the Nichols chart:

- **Peak Response** — The maximum value of the Nichols chart in the plotted region.
- **Stability (Minimum Crossing)** — The minimum gain and phase margins for the Nichols chart.
- **Stability (All Crossings)** — Display all gain stability margins

Singular Values

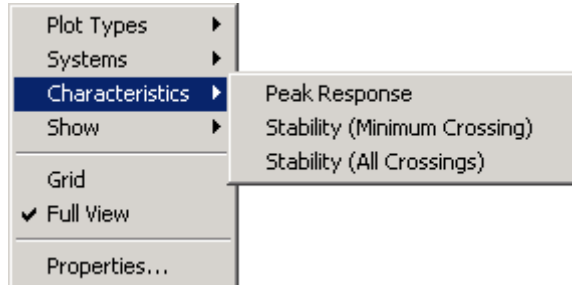

Singular Values plots the singular values for the model.

The LTI Viewer can display the **Peak Response**, which is the largest magnitude of the Singular Values curve over the plotted region.

Pole/Zero and I/O Pole/Zero

Pole/Zero plots the poles and zeros of the model with 'x' for poles and 'o' for zeros. I/O Pole/Zero plots the poles and zeros of I/O pairs.

There are no **Characteristics** available for pole-zero plots.

Adding Design Requirements

If you open an LTI Viewer for the Graphical Tuning window, you have plots linked to your compensator design. In this environment, the LTI Viewer provides access to design requirements, a set of graphical tools for creating constraints in your design plots.

In addition to all the design requirements available in the Graphical Tuning window, the LTI Viewer has the step response design requirements described in “Choosing Step Response Specifications” on page 18-9.

For more information on adding design requirements to LTI Viewer plots, see “LTI Viewer for SISO Design Task Design Requirements” on page 17-80.

Note Design requirements are not available from an LTI Viewer that is opened using the `ltiview` command.

Choosing Step Response Specifications

To specify step response characteristics select **Design Requirements > New** in the right-click menu. This action opens the **New Design Requirements** editor. Select **step response bounds** from the **Design requirement type** pull down menu to display the step response specifications as shown below.

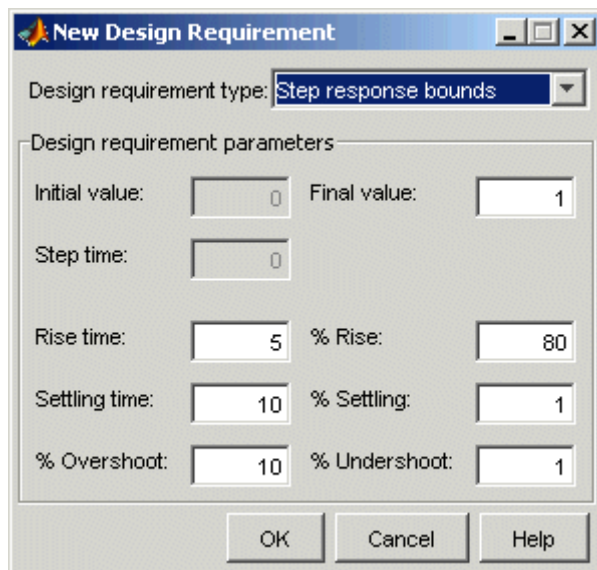

The top three options specify the details of the step input:

- **Initial value:** input level before the step occurs. This option is grayed out because LTI systems always have initial value equal to 0.
- **Step time:** time at which the step takes place. This option is grayed out since LTI systems always have an initial time equal to 0.
- **Final value:** input level after the step occurs

The remaining options specify the characteristics of the response signal. Each of the step response characteristics is described in the figure below.

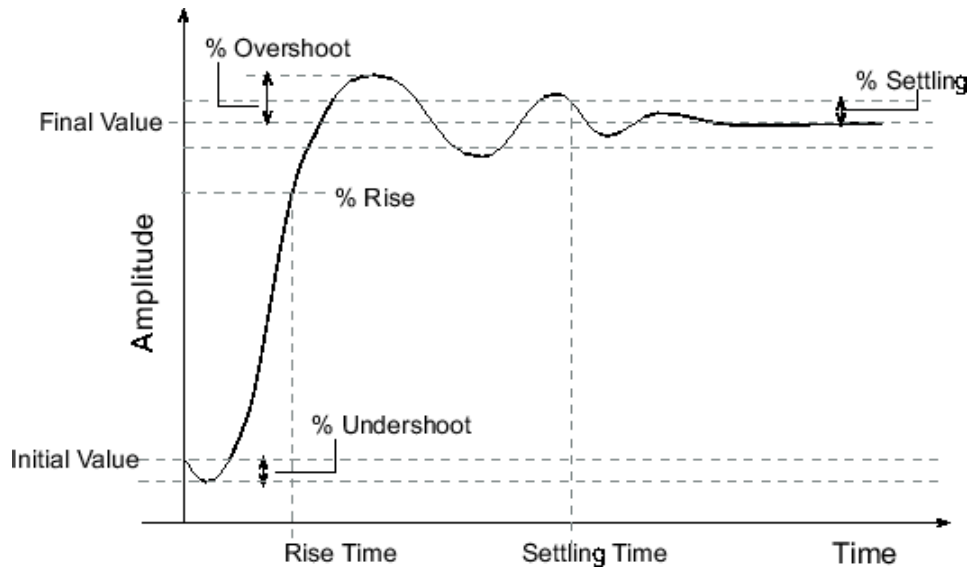

- **Rise time:** The time taken for the response signal to reach a specified percentage of the step's range. The step's range is the difference between the final and initial values.
- **% Rise:** The percentage used in the rise time.
- **Settling time:** The time taken until the response signal settles within a specified region around the final value. This settling region is defined as the final step value plus or minus the specified percentage of the final value.
- **% Settling:** The percentage used in the settling time.
- **% Overshoot:** The amount by which the response signal can exceed the final value. This amount is specified as a percentage of the step's range. The step's range is the difference between the final and initial values.
- **% Undershoot:** The amount by which the response signal can undershoot the initial value. This amount is specified as a percentage of the step's range. The step's range is the difference between the final and initial values.

Enter values for the response specifications in the **Design Requirements** editor, based on the requirements of your model, and then click **OK**. The constraint edges will now reflect the constraints specified.

Importing, Exporting, and Deleting Models in the LTI Viewer

In this section...

“Importing Models” on page 18-12

“Exporting Models” on page 18-13

“Deleting Models” on page 18-14

Importing Models

To import models into the LTI Viewer, select **Import** under the **Edit** menu. This opens the **LTI Browser**, shown below.

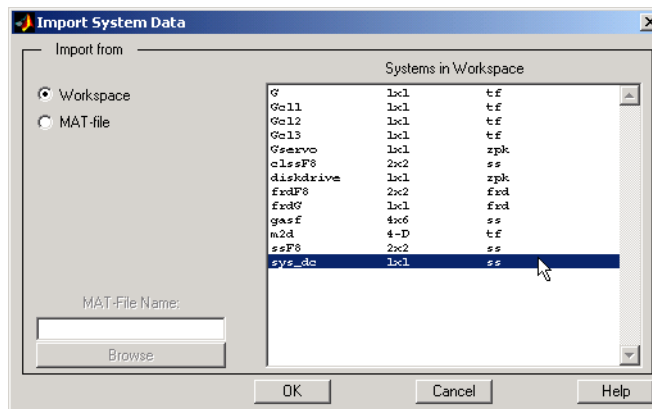

Use the **LTI Browser** to import LTI models into or from the LTI Viewer workspace.

To import a model:

- Click on the desired model in the LTI Browser List. To perform multiple selections:
 - Hold the Control key and click on nonadjacent models.
 - Hold the Shift key while clicking to select multiple adjacent models.

- Click the **OK** or **Apply** Button

Note that the **LTI Browser** lists only the LTI models in the MATLAB workspace.

Alternatively, you can directly import a model into the LTI Viewer using the `ltiview` function, as in

```
ltiview({'step', 'bode'}, modelName)
```

See the `ltiview` function for more information.

Exporting Models

Use **Export** in the **File** menu to open the **LTI Viewer Export** window, shown below.

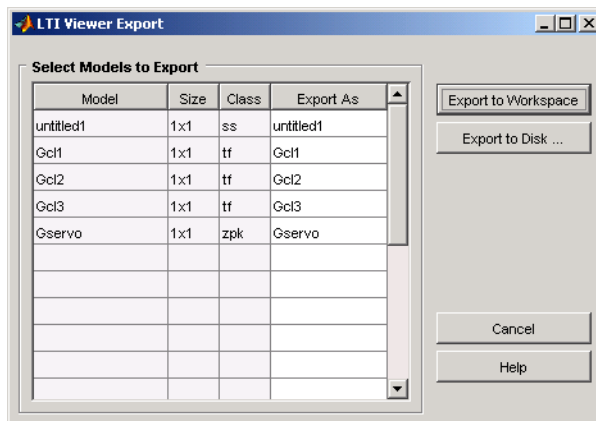

The **LTI Viewer Export** window lists all the models with responses currently displayed in your LTI Viewer. You can export models back to the MATLAB workspace or to disk.

To export single or multiple models, follow the steps described in the importing models section above. If you choose **Export to Disk**, this window opens.

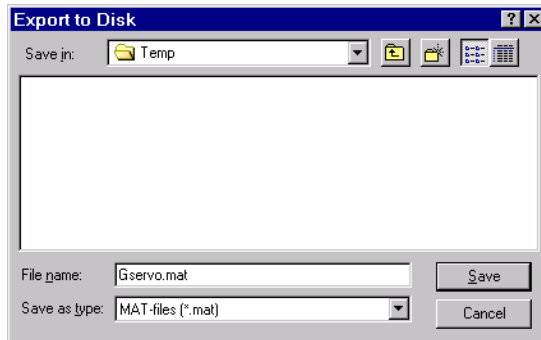

Choose a name for your model(s) and click **Save**. Your models are stored in a MAT-file.

Deleting Models

Select **Edit->Delete Systems** to open the **LTI Viewer Delete** window.

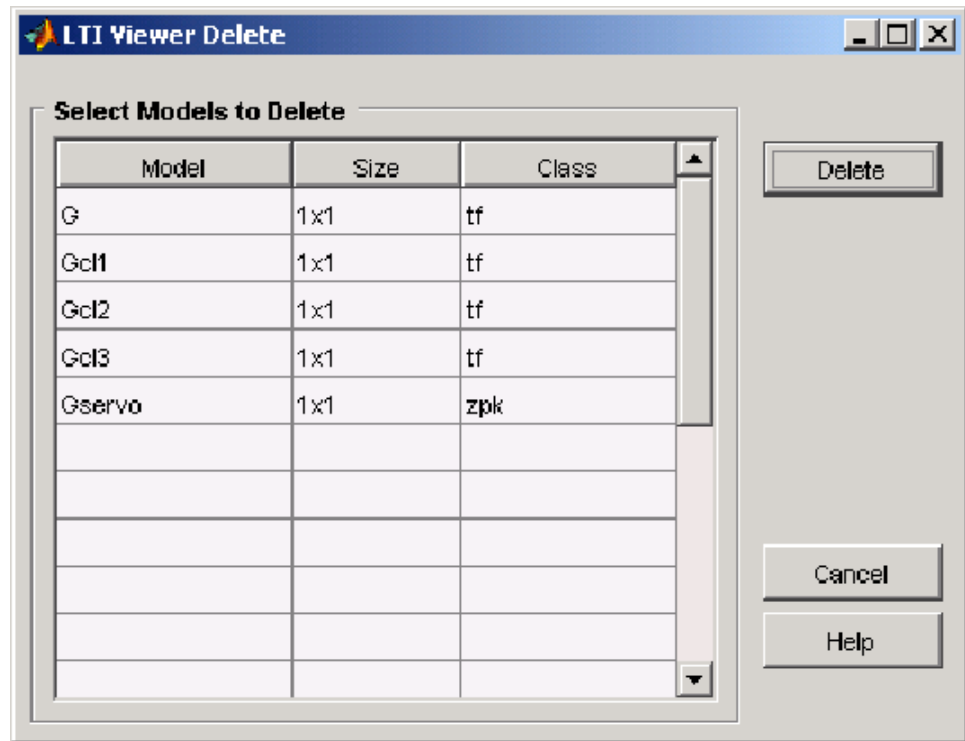

To delete a model:

- Click on the desired model in the Model list. To perform multiple selections:
 - 1 Click and drag over several variables in the list.
 - 2 Hold the Control key and click on individual variables.
 - 3 Hold the Shift key while clicking, to select a range.

Click the **Delete** button.

Selecting Response Types

In this section...

“Methods for Selecting Response Types” on page 18-16

“Right Click Menu: Plot Type” on page 18-16

“Plot Configurations Window” on page 18-16

“Line Styles Editor” on page 18-18

Methods for Selecting Response Types

There are two methods for selecting response plots in the LTI Viewer:

- Selecting **Plot Type** from the right-click menus
- Opening the **Plot Configurations** window

Right Click Menu: Plot Type

If you have a plot open in the LTI Viewer, you can switch to any other response plot available by selecting **Plot Type** from the right click menu.

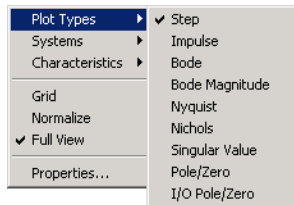

To change the response plot, select the new plot type from the **Plot Type** submenu. The LTI Viewer automatically displays the new response plot.

Plot Configurations Window

The Plot Type feature of the right-click menu works on existing plots, but you can also add plots to an LTI Viewer by using the **Plot Configurations** window. By default, the LTI Viewer opens with a closed-loop step response. To reconfigure an open viewer, select **Plot Configuration** in the **Edit** menu.

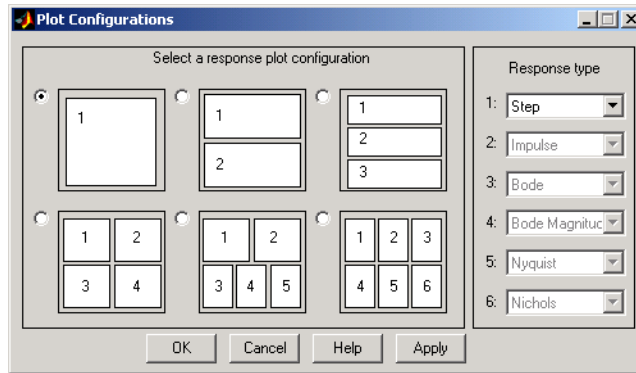

Use the radio buttons to select the number of plots you want displayed in your LTI Viewer. For each plot, select a response type from the menus located on the right-hand side of the window.

It's possible to configure a single LTI Viewer to contain up to six response plots.

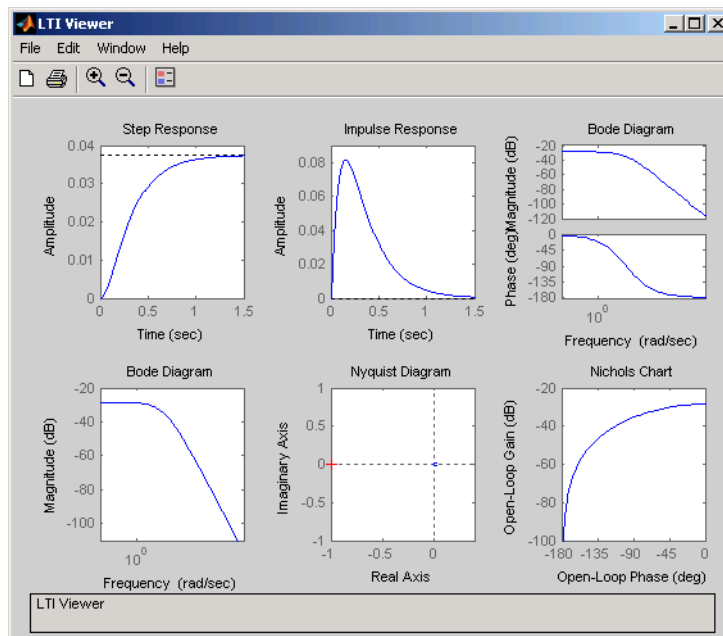

Available response plots include: step, impulse, Bode (magnitude and phase, or magnitude only), Nyquist, Nichols, sigma, pole/zero maps, and I/O pole/zero maps.

Line Styles Editor

Select **Edit-> Line Styles** to open the **Line Styles** editor.

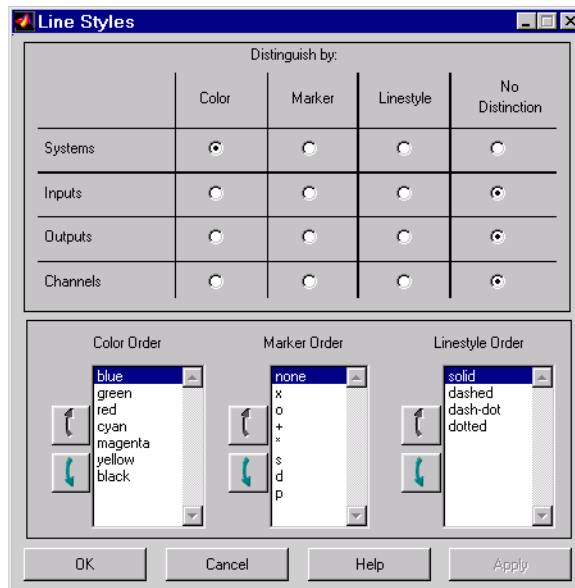

The **Line Styles** editor is particularly useful when you have multiple systems imported. You can use it change line colors, add and rearrange markers, and alter line styles (solid, dashed, and so on).

You can use the **Linestyle Preferences** window to customize the appearance of the response plots by specifying:

- The line property used to distinguish different systems, inputs, or outputs
- The order in which these line properties are applied

Each LTI Viewer has its own **Linestyle Preferences** window.

Setting Preferences

You can use the "Distinguish by" matrix (the top half of the window) to specify the line property that will vary throughout the response plots. You can group multiple plot curves by systems, inputs, outputs, or channels (individual input/output relationships). Note that the Line Styles editor uses radio buttons, which means that you can only assign one property setting for each grouping (system, input, etc.).

Ordering Properties

The **Order** field allows you to change the default property order used when applying the different line properties. You can reorder the colors, markers, and linestyle (e.g., solid or dashed).

To change any of the property orders, click the up or down arrow button to the left of the associated property list to move the selected property up or down in the list.

Analyzing MIMO Models

In this section...

“Overview of Analyzing MIMO Models” on page 18-20

“Array Selector” on page 18-21

“I/O Grouping for MIMO Models” on page 18-23

“Selecting I/O Pairs” on page 18-24

Overview of Analyzing MIMO Models

If you import a MIMO system, or an LTI array containing multiple linear models, you can use special features of the right-click menu to group the response plots by input/output (I/O) pairs or select individual plots for display. For example, if you randomly generate a 3-input, 3-output MIMO system,

```
sys_mimo=rss(3,3,3);
```

and open an LTI Viewer,

```
ltiview(sys_mimo);
```

the default is an unwrapped set of 9 plots, one from each input to each output.

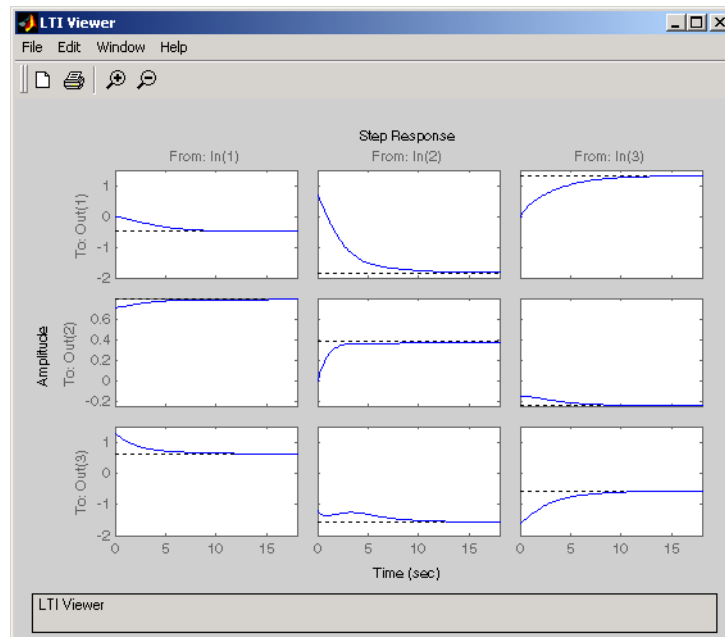

Array Selector

If you import an LTI array into your LTI Viewer, **Array Selector** appears as an option in the right-click menu. Selecting this option opens the **Model Selector for LTI Arrays**, shown below.

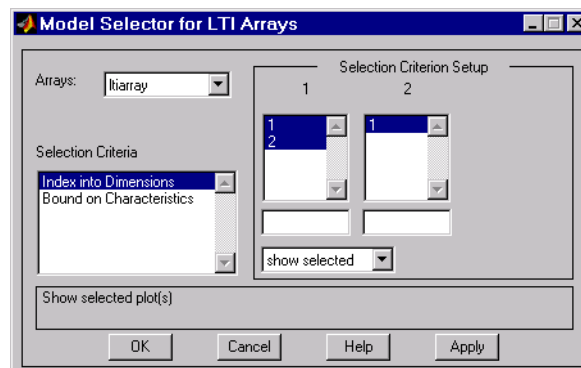

You can use this window to include or exclude models within the LTI array using various criteria. The following subsections discuss the features in turn.

Arrays

Select which LTI array for applying model selection options by using the Arrays pull-down list.

Selection Criteria

There are two selection criteria. The default, **Index into Dimensions**, allows you to include or exclude specified indices of the LTI Array. Select systems from the **Selection Criteria Setup** and specify whether to show or hide the systems using the pull-down menu below the Setup lists.

The second criterion is **Bound on Characteristics**. Selecting this options causes the Model Selector to reconfigure. The reconfigured window is shown below.

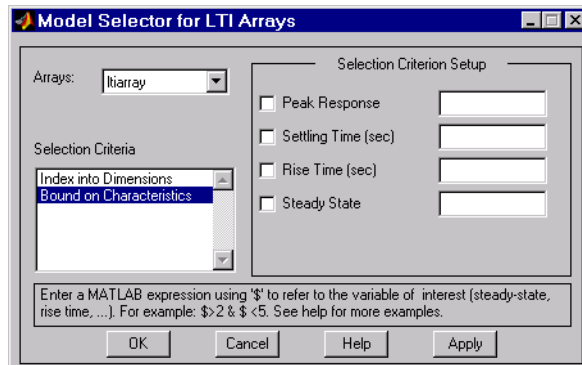

Use this option to select systems for inclusion or exclusion in your LTI Viewer based on their time response characteristics. The panel directly above the buttons describes how to set the inclusion or exclusion criteria based on which selection criteria you select from the reconfigured **Selection Criteria Setup** panel.

I/O Grouping for MIMO Models

You can group this by inputs, by outputs, or both by selecting **I/O Grouping** and then **Inputs**, **Outputs**, or **All**, respectively, from the right-click menu.

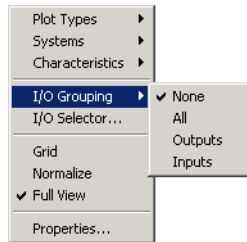

For example, if you select **Outputs**, the LTI Viewer reconfigures into 3 plots, one for each input.

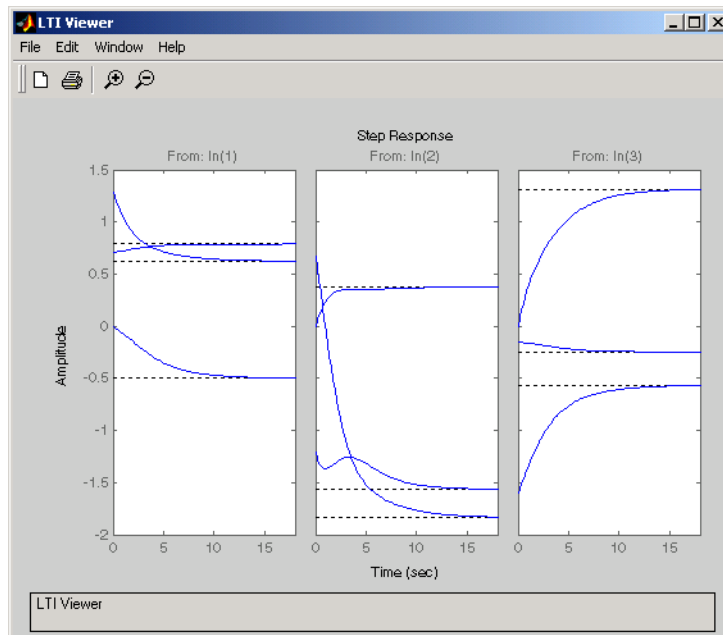

Selecting **None** returns to the default configuration, where all I/O pairs are displayed individually.

Selecting I/O Pairs

Another way to organize MIMO system information is to choose **I/O Selector** from the right-click menu, which opens the **I/O Selector** window.

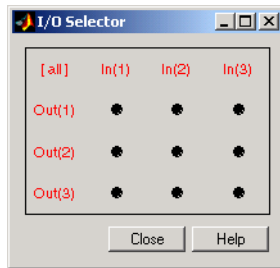

This window automatically configures to the number of I/O pairs in your MIMO system. You can select:

- Any individual plot (only one at a time) by clicking on a button
- Any row or column by clicking on Y^* or U^*
- All of the plots by clicking [all]

Using these options, you can inspect individual I/O pairs, or look at particular I/O channels in detail.

Customizing the LTI Viewer

In this section...

“Overview of Customizing the LTI Viewer” on page 18-25

“LTI Viewer Preferences Editor” on page 18-25

Overview of Customizing the LTI Viewer

The LTI Viewer has a tool preferences editor, which allows you to set default characteristics for specific instances of LTI Viewers. If you open a new instance of either, each defaults to the characteristics specified in the **Toolbox Preferences** editor.

LTI Viewer Preferences Editor

Select **Viewer Preferences** in the **Edit** menu of the LTI Viewer to open the **LTI Viewer Preferences** editor. This figure shows the editor open to its first pane.

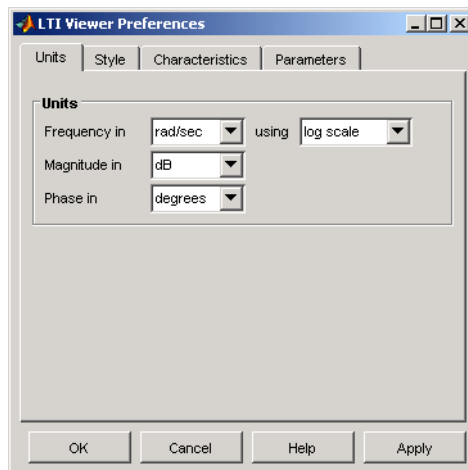

The **LTI Viewer Preferences** editor contains four panes:

- Units--Convert between various units, including rad/sec and Hertz

- Style--Customize grids, fonts, and colors
- Characteristics--Specify response plot characteristics, such as settling time tolerance
- Parameters--Set time and frequency ranges, stop times, and time step size

If you want to customize the settings for all instances of LTI Viewers, see the Toolbox Preferences editor.

A

array selector for LTI Viewer 18-21
arrays. *See* Model arrays 2-59

C

classical control 15-2 15-19
closed loop.. *See* feedback
connection
 feedback 15-11
 parallel 15-54
 series 15-14
conversion, model
 automatic 5-3
 between model types 5-2
 discrete to continuous (d2c)
 with negative real poles 5-21
 FRD model, to 5-2
 SS model, to 5-2
 state-space, to 5-3
 TF model, to 5-2
 ZPK model, to 5-2
covariance
 error 15-56 15-61
creating model arrays 2-59
customizing plots 14-2
customizing subplots 14-18

D

delays
 discretization 5-21
 Pade approximation 2-29
denominator
 specification 1-19
descriptor systems.. *See* state-space models,
 descriptor
design
 classical 15-2 15-19
 Kalman estimator 15-35 15-49 15-57

LQG 15-30
regulators 15-30
robustness 15-27
root locus 15-8 15-23

desired responses
 step responses 18-9
discrete-time models
 control design 15-19
 Kalman estimator 15-50
discretization 15-20
 delay systems 5-21
 first-order hold 5-22
 matched poles/zeros 5-27
 Tustin method 5-24
 zero-order hold 5-20

E

error covariance 15-56 15-61

F

feedback 15-11
filtering.. *See* Kalman estimator
first-order hold (FOH) 5-22
 with delays 5-21
FRD (frequency response data) objects 1-22
 conversion to 5-2
frequency response 1-23

G

gain margins 15-27
Graphical design window 17-2
Graphical Tuning Preferences Editor 13-9

K

Kalman
 filtering 15-49
Kalman estimator

- continuous 15-35
- discrete 15-50
- time-varying 15-57

L

- LQG (linear quadratic-gaussian) method
 - continuous LQ regulator 15-35
 - cost function 15-35
 - design 15-30 15-45
 - LQ-optimal gain 15-35
 - regulator 15-30

- LTI arrays
 - conversion, model.. *See* conversion

- LTI models
 - conversion 5-2 5-21
 - See also* conversion, model
 - discretization, matched poles/zeros 5-27

- LTI Viewer
 - array selector 18-21
 - configuring plots 18-16
 - customization 18-25
 - I/O grouping 18-23
 - importing/exporting models 18-12
 - MIMO models 18-20
 - overview 18-2
 - right-click menu 18-4
 - selecting I/O pairs 18-24
 - selecting response types 18-16
 - SISO Design Task 17-2

- LTI Viewer Preferences Editor 13-3

M

- margins, gain and phase 15-27
- model arrays
 - creating model arrays 2-59
- Model arrays 2-59
- model building
 - feedback connection 15-11

- parallel connection 15-54
- series connection 15-14

N

- numerator
 - specification 1-19

P

- Pade approximation (pade) 2-29
- parallel connection 15-54
- phase margins 15-27
- plot customization 14-2
- Plot Tools 14-19
- Property Editor 14-3

R

- regulation 15-30
- robustness 15-27
- root locus 15-23
 - design 15-8 15-23
 - See also* Root Locus Design GUI

S

- scaling 16-2
- series connection 15-14
- SISO Design Task in the Control and Estimation Tools Manager 17-2
- SISO Design Tool 17-2
 - customizing plots 14-48
 - root locus right-click menu 17-58
- state 1-21 to 1-22
- state-space models
 - conversion to 5-2
 - See also* conversion 5-2
 - descriptor 1-21
 - matrices 1-20
 - model data 1-20

- scaling 16-2
- specification 1-20
- step responses
 - specifications 18-9
- subplot customization 14-18

T

- time-varying Kalman filter 15-57
- Toolbox Preferences Editor 12-2
- transfer functions
 - conversion to 5-2
 - denominator 1-19

- numerator 1-19
 - specification 1-19
- triangle approximation 5-22
- Tustin approximation 5-24
 - with frequency prewarping 5-25

Z

- zero-order hold (ZOH) 5-20 15-20
 - with delays 5-21
- zero-pole-gain (ZPK) models
 - conversion to 5-2